

GMC

# Motor Home

OPERATING MANUAL

IMPORTANT  
OPERATING  
SAFETY AND  
MAINTENANCE  
INSTRUCTIONS  
—  
WARRANTIES



## A Word To The GMC Motor Home Owner...

*Congratulations on your purchase of a GMC Motor Home. You have opened the way to an endless variety of happy holidays.*

*We have prepared this manual to assist you in properly operating and maintaining your Motor Home, and to provide important safety information. We urge you to read this manual carefully and follow the recommendations contained to help assure the most enjoyable and trouble-free operation of your vehicle. In the "Warranties" section of this manual you will find the New Vehicle Warranty and the Emission Control Systems Warranty.*

*When it comes to service, remember that your GMC Motor Home Service Outlet knows your vehicle best and is interested in your complete satisfaction. Return to him for service and any other assistance you may require.*

*GMC Truck and Coach maintains a number of Zone Offices throughout the country. Should you have a problem that cannot be handled through normal channels, please follow the procedure described under the "Owner Assistance" section.*

*Thank you for choosing a GMC Motor Home. We extend our best wishes for many years of pleasant traveling.*

*Cordially,*

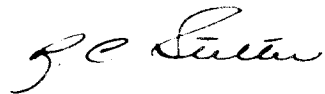

*R. C. Stelter  
General Sales Manager*

# **GMC MOTOR HOME OPERATING MANUAL**

## **IMPORTANT**

This manual should be considered a permanent part of the vehicle and must remain with the vehicle at time of re-sale.

All information, illustrations and specifications contained in this manual are based on the latest product information available at the time of publication. The right is reserved to make changes at any time without notice.

For vehicles sold in Canada, substitute the name General Motors of Canada whenever the name GMC Truck & Coach Division appears in this manual.

*Service Publications*

**GMC TRUCK & COACH DIVISION  
GENERAL MOTORS CORPORATION  
Pontiac, Michigan 48053**

# TABLE OF CONTENTS

SUBJECT	PAGE NO.	SUBJECT	PAGE NO.
<b>Important Information on</b>		Fuel Gauge.....	20
<u>Vehicle Loading</u> .....	1	Temperature Gauge.....	21
<b>Before Driving Your Motor Home</b> .....	5	Oil Pressure Gauge.....	21
Driver Checklist.....	5	Charging System Warning Light.....	21
Inside Rearview Mirror.....	5	Brake System Warning Light.....	21
Seats.....	6	Tell-Tale Warning Light Cluster.....	22
Keys.....	7	Headlight Switch.....	22
Entrance Door.....	7	Windshield Wiper Lever.....	22
Lap Belts.....	8	Windshield Washers.....	23
Child Restraint.....	9	Fuel Selector Switch.....	23
Vehicles Not Equipped With		Battery Boost Switch.....	23
Special Child Restraints.....	9	Cigar-Cigarette Lighter.....	23
Operation In Foreign Countries.....	9	Heating System (Without	
Trailer Hauling.....	10	Automotive Air Conditioner).....	23
Trip Tips.....	10	Automotive Air Conditioner.....	24
Driving Tips.....	11	Radios and Tape Deck.....	25
New Vehicle Operating Speeds.....	11	Mobile Radio Transmitters.....	27
<b>Starting and Operating Vehicle</b> .....	13	Power Level System.....	27
Engine Exhaust Gas Caution.....	13	<b>Operation of Living Area Facilities</b> .....	29
Steering Column Controls.....	14	Living Area Facilities Caution.....	29
Anti-Theft Steering Column Lock.....	14	Living Area Electrical System.....	29
Parking.....	14	General Information.....	29
Starting Engine.....	14	120-Volt & 12-Volt	
Automatic Transmission.....	15	Converter and Battery Charger... ..	29
Turn Signals and		External Power.....	30
Lane Change Feature.....	16	Lighting System.....	31
Hazard Warning Flasher.....	16	Monitor Panel.....	31
Horn Control.....	16	Onan Motor Generator.....	31
Power Steering.....	16	Kohler Motor Generator.....	32
Tilt Steering Wheel.....	16	Living Area Water System.....	33
Cruise Control.....	17	Filling Water Tank.....	35
Floor Controls.....	17	External Water Connection.....	35
Brake System.....	17	Water Pump.....	35
Headlight Dimmer Switch.....	19	Water Heater.....	36
Headlight "Flicker".....	19		
Instrument Panel and Controls.....	20		
Speedometer and Odometer.....	20		

# TABLE OF CONTENTS

SUBJECT	PAGE NO.	SUBJECT	PAGE NO.
Kitchen Facilities.....	37	Kitchen Sink.....	60
All Electric Refrigerator.....	37	Cleaning Fabrics.....	60
Gas/Electric Refrigerator.....	38	Removal of Specific Stains.....	60
Kitchen Range/Oven.....	40	Exterior Appearance Care.....	61
Kitchen Sink and		Bright Metal Parts.....	61
Auxiliary Water Purifier.....	43	Exterior Glass.....	61
Bathroom Facilities.....	43	Polishing and Waxing.....	62
Standard Toilet.....	43	Touch-up Paint.....	62
Recirculating Toilet.....	43	Undercoating.....	62
Bathroom Sink and		<b><u>Service and Maintenance</u>.....</b>	<b>63</b>
Shower Control Valve.....	45	Accessibility.....	63
Shower Head.....	45	Exterior Compartments.....	63
Thermasan System.....	46	Engine Accessibility.....	65
Ventilation.....	47	Roof Carrier.....	66
Windows.....	47	Hoisting Instructions.....	66
Ceiling Vent.....	47	Complete Vehicle Maintenance	
Roof-Mounted Air Conditioner.....	47	Schedule.....	67
Furnace.....	48	GMC Motor Home Maintenance	
Furniture.....	50	Information.....	68
<b><u>In case of emergency</u>.....</b>	<b>53</b>	Explanation of Complete Vehicle	
Four-Way Hazard Warning Flasher...	53	Maintenance Schedule.....	68
Emergency Starting.....	53	Lube & General Information.....	68
Engine Coolant Caution.....	55	Safety Maintenance.....	69
Jack Usage Instructions.....	55	Emission Control Maintenance.....	71
Towing Motor Home.....	56	Motor Generator Maintenance	
Freeing Vehicle From Sand, Etc.....	57	Details.....	72
Emergency Exit.....	57	Onan 4000/6000 Watt Motor	
Fire Extinguisher.....	57	Generator Maintenance Schedule...	73
<b><u>Appearance Care</u>.....</b>	<b>59</b>	Kohler 4000 Watt Motor Generator	
Care and Cleaning of Interior		Maintenance Schedule.....	73
General Information.....	59	Recommended Fluids & Lubricants...	74
Vacuum Cleaner.....	59	Lubrication Details.....	75
Lap Belt Care.....	60	Engine.....	75
Interior Glass.....	60	Transmission.....	77

# TABLE OF CONTENTS

SUBJECT	PAGE NO.	SUBJECT	PAGE NO.
Final Drive	78	Sanitizing Living Area Water System	105
Steering System	78	Winterization	106
Brake System	79	Vehicle Storage	106
Servicing Details	79	<b><u>New Vehicle Warranty</u></b>	<b>111</b>
Engine Cooling System	79	<b><u>Emission Control Systems Information</u></b>	
Engine Fuel System	81	<b><u>And Warranty</u></b>	<b>115</b>
LP Gas System	84	<b><u>General Data and Specifications</u></b>	<b>119</b>
Chassis Electrical System	84	<b><u>Owner Assistance</u></b>	<b>127</b>
Living Area Electrical System	88	U.S. Motor Home Service Outlet Locations	128
Onan Motor Generator Maintenance	91	U.S. Zone Territories	131
Kohler Motor Generator Maintenance	95	U.S. Zone Offices	132
Wheels and Tires	96	Mexico Zone Office	132
Front Suspension	99	GM of Canada Limited—Zone Offices	133
Rear Suspension	100	Sudden Service System	134
Thermasan System	101	After-Hour Service Assistance	134
Standard Toilet	101	Maintenance Manual	134
Recirculating Toilet	102	Index	135
Draining Holding Tank	103	Gas Station Information	141
Draining Living Area Water System	104		

# IMPORTANT INFORMATION ON VEHICLE LOADING

## CAUTION

The components of your Motor Home are designed to provide satisfactory service if the vehicle is not loaded in excess of either the gross vehicle weight, or the maximum front and rear end weights, specified on a permanent place which is located behind the right engine access door. Overloading can create serious potential safety hazards and can also shorten the service life of your vehicle. Your local dealer can advise you concerning proper loading conditions of your vehicle.

When loading the Motor Home, it is important that it is properly loaded. All items should be loaded as centrally and as low as possible. This is essential to maintain proper vehicle handling. Even though a single item may not weigh much alone, several of these items may have considerable weight. Proper loading is essential.

## MAXIMUM FRONT AND REAR AXLE WEIGHTS

The weight of the load must be properly distributed over both the front and the rear axles, although not necessarily evenly. The plate shows the maximum weight that the front axle can carry and the maximum weight that the rear axles can carry. Note that the sum of these is greater than the GVW, so that it is not necessarily proper to load both axles, at the same time, to the maximum capacity shown for each. The GVW rating represents the weight that the complete vehicle is designed to carry, taking into consideration the engine, transmission, frame, spring, and tire capabilities. Actual front and rear end weights at the ground can only be determined by weighing the vehicle. This can be accomplished through highway weigh stations or other such commercial facilities. For assistance in this regard, consult your service outlet.

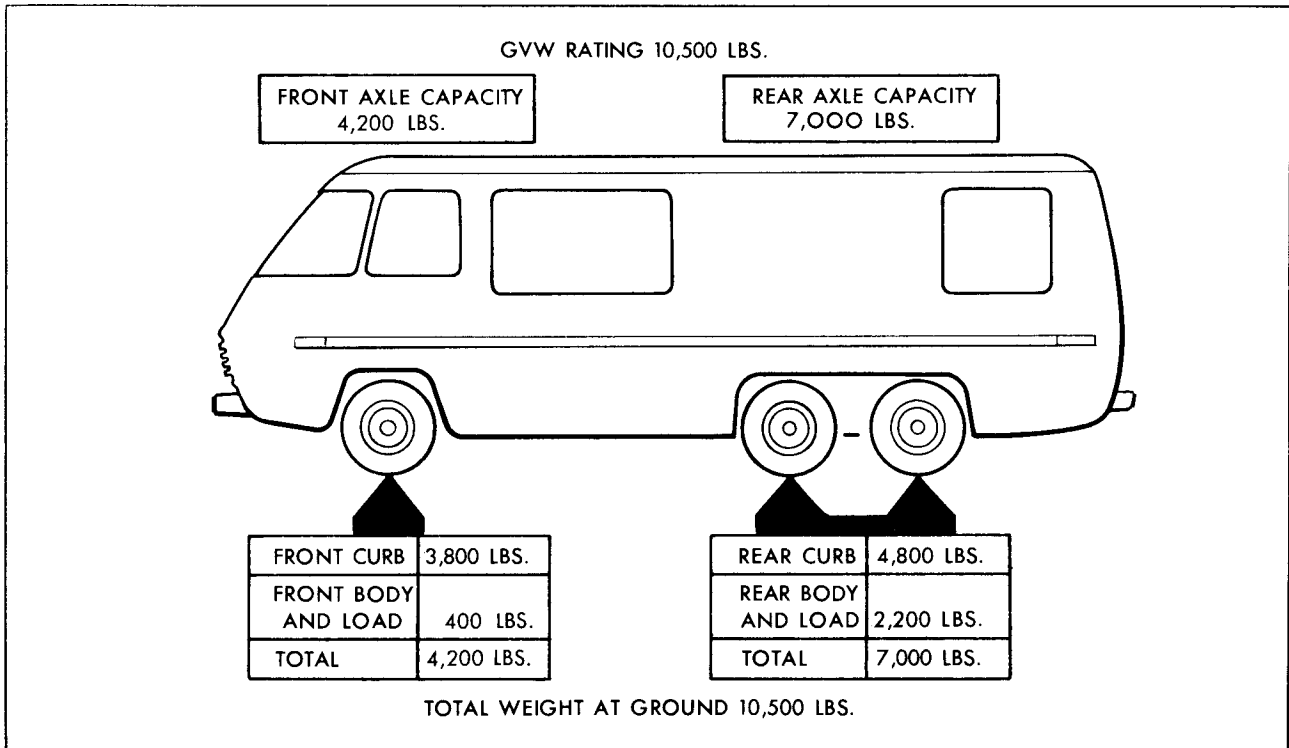

*Vehicle Loading (Model 230)*

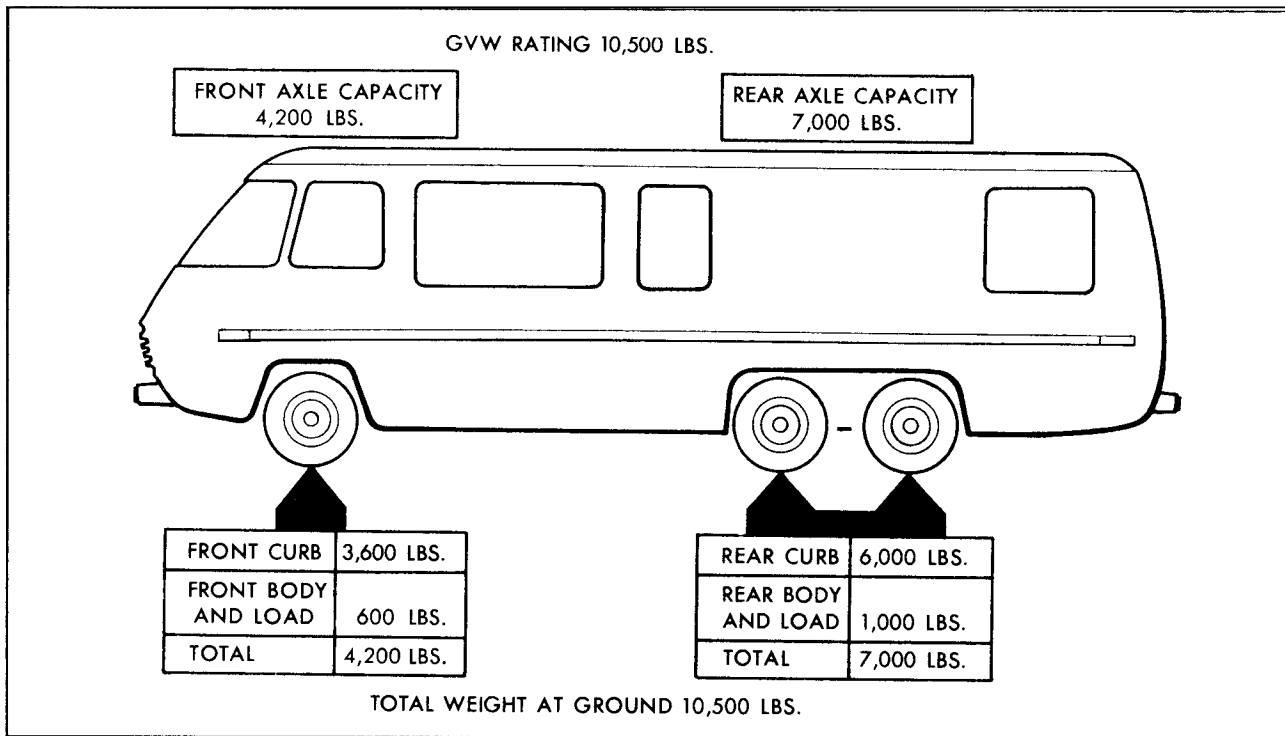

*Vehicle Loading (Model 260)*

**GENERAL MOTORS CORPORATION**

WARRANTY MAY BE VOIDED IF WEIGHT EXCEEDS ANY OF THE RATINGS SHOWN.

GROSS VEHICLE WEIGHT INCLUDES WEIGHT OF BASE VEHICLE, ALL ADDED EQUIPMENT, DRIVER AND PASSENGERS, AND ALL PROPERTY LOADED INTO VEHICLE.

\*REFER TO OWNER'S MANUAL FOR EQUIPMENT REQUIRED FOR INTERMEDIATE OR MAXIMUM GVW RATINGS, AND FOR OTHER LOADING INFORMATION, INCLUDING TIRE INFLATION.

	RATINGS IN POUNDS	
	AS MANUFACTURED	*MAXIMUM CAPABILITY
GROSS VEHICLE WEIGHT FOR THIS VEHICLE	<input style="width: 60px; height: 20px;" type="text"/>	<input style="width: 60px; height: 20px;" type="text"/>
MAXIMUM FRONT END WEIGHT AT GROUND	<input style="width: 60px; height: 20px;" type="text"/>	<input style="width: 60px; height: 20px;" type="text"/>
MAXIMUM REAR END WEIGHT AT GROUND	<input style="width: 60px; height: 20px;" type="text"/>	<input style="width: 60px; height: 20px;" type="text"/>
VEHICLE IDENT. NO.	<input style="width: 200px; height: 20px;" type="text"/>	

*Vehicle Identification Plate*

A-0414

**GVW (GROSS VEHICLE WEIGHT)**

The permanent plate located behind the right engine access door shows the "As Manufactured" Gross Vehicle Weight Rating (GVW) and the "Maximum Capability" rating for the Motor Home to which it is attached.

The "As Manufactured" rating represents the vehicle's load carrying capabilities as initially manufactured.

The "Maximum Capability" rating shown on the plate is the manufacturer's gross weight rating which is attainable for that vehicle, provided the required optional equipment is installed.

"Gross Vehicle Weight" means the maximum design weight of the Motor Home, including the Motor Home itself, all items added to the Motor Home after it has left the factory, and everything that is loaded into (or onto) the Motor Home. **IMPORTANT:** Under no conditions should racks, carriers, luggage, tires, or any other items be loaded on the front of the Motor Home so as to block air flow and interfere with engine cooling.

If the vehicle is equipped with the optional roof mounted carrier, trunk, or motorcycle rack, the design weight limitations of these items must not be exceeded. The roof mounted carrier has a capacity of 250 lbs. The trunk has a capacity



of 250 lbs. The load on the motorcycle rack must not exceed 250 lbs.

**NOTE:** The addition of these options does not increase the maximum axle or gross vehicle weight ratings of the vehicle.

#### **EFFECT ON WARRANTY**

Your GMC Motor Home New Vehicle Warranty does not apply to any part of your vehicle "which has been subject to misuse." Any part which fails because of overloading has been subject to misuse within the meaning of this provision of the Warranty.

#### **TIRES**

It is important that the tires on your vehicle be of proper size, and be properly inflated. It is important to avoid over-inflation as well as under-inflation. Refer to "WHEELS AND TIRES" later in this manual under "SERVICING DETAILS" for tire inflation information.

#### **REAR BUMPER LOADING**

Care must be taken with racks or temporary attachments, when attached to the rear bumper. Such items could nullify the energy absorbing capabilities of the rear bumper. Your GMC Motor Home service outlet can advise you as to suitable means of attachment.

For continuing satisfaction keep your Motor Home all GM. General Motors Parts are identified by one of these trademarks:



# BEFORE DRIVING YOUR MOTOR HOME

## DRIVER CHECK LIST

### BEFORE ENTERING VEHICLE

1. See that windows, mirrors, and lights are clean.
2. Check inflation condition of tires.
3. Turn off LP gas valve on LP tank (See CAUTION under "LP Gas System" in SERVICE AND MAINTENANCE section).
4. Check that sewer connection, all external compartments, and filler openings are properly stowed or closed and/or locked.
5. Check that items stored on exterior of vehicle are securely lashed.
6. Will any items stored on exterior of vehicle present a clearance problem?
7. Are there any rocks, posts, low-hanging lines or branches under or near the vehicle you must avoid before driving away?
8. Check that area to rear of vehicle is clear if about to back-up.

### BEFORE DRIVING OFF

1. Lock entrance door.
2. Check that all windows and vents are in suitable position for travel (See "Engine Exhaust Gas Caution (Carbon Monoxide)" at the beginning of STARTING AND OPERATING VEHICLE section).
3. Turn off living area water pump.
4. Check that refrigerator door is fastened.
5. Check that nothing heavy is stored in overhead or high cabinets—it may fall out enroute and cause injury.
6. Close and secure bathroom, closet, and all cabinet doors and drawers.
7. Check that counter tops, range top, table tops and shelves are clear—even small items may become projectiles in an accident. It is not safe to cook while underway—hot food or liquid may scald in a sudden stop or accident.
8. Be sure all LP gas controls on furnace, range/oven, and optional gas/electric refrigerator are turned off.
9. Check that all interior stowage is securely held.

10. Check that all lights and switches are set in positions suitable for travel.
11. Position driver's seat for comfort.
12. Check that driver's and front passenger's seat, and any other swivel-mounted seats are locked in position.
13. Check adjustment of inside and outside mirrors. Adjust curtains where necessary for visibility.
14. If vehicle is equipped with optional Power Level System, check that both control knobs are set to "TRAVEL" position. Check that battery switch is in "BAT NORMAL" position.
15. Fasten lap belts.
16. Check that warning light bulbs light when key is turned to ON or START position.
17. With engine running, check that warning lights are now out.
18. Be sure you understand your vehicle and how to operate it and its systems safely.
19. It is recommended that you refer to "TRIP TIPS" and "DRIVING TIPS" at the end of this section for additional information.

### CAUTION

Counter and table tops should not be used for storage when underway—even for light weight, small articles. They might become dangerous projectiles during an accident. Heavy items stored in overhead or waist-high cabinets may also cause injury if a sharp turn or stop causes them to topple against inside of cabinet door, forcing it open. Store canned goods and other heavy items down low.

### INSIDE REARVIEW MIRROR

Switch inside mirror (see next page) to night position to reduce glare from following headlights.

To raise or lower, grasp mirror and exert sufficient pressure by pushing or pulling to move mirror up or down.

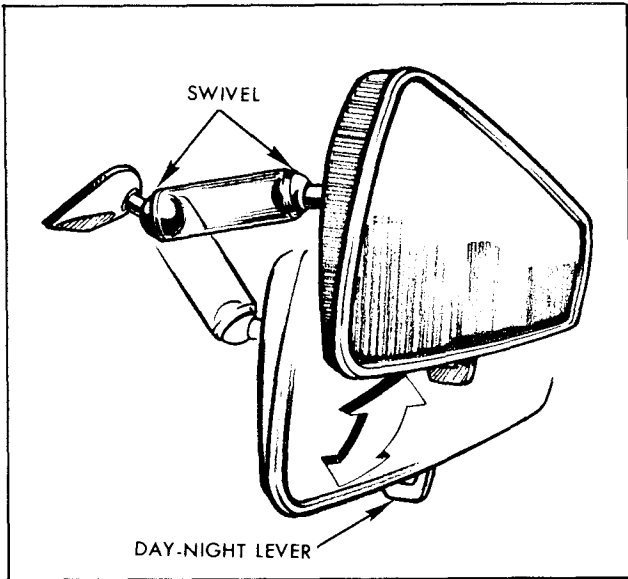

*Inside Rearview Mirror*

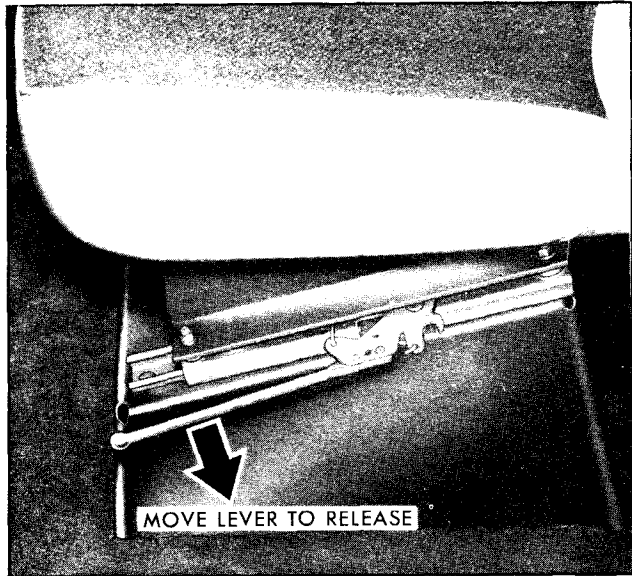

*Seat Track Mechanism*

### SEATS

The driver and passenger seats in the driver compartment may be adjusted to suit an individual's preference (except dual passenger seat). To move seat forward or backward, simply release the seat locking lever located on the left side of the seat. Once released, exert slight body pressure in the direction desired. Release lever to lock the seat in the desired position.

The seats can be swiveled (except dual passenger seat in Model 260) to provide easy entrance and exit. To turn swivel seat, release lock-

ing mechanism by moving seat swivel lever, then turn seat.

### CAUTION

Check that all swiveling seats are locked in position before driving off. If any seat swiveled during an accident the occupant may be more likely injured. **DO NOT** adjust the driver's seat swivel or fore and aft mechanism while the vehicle is moving. The seat could move unexpectedly causing loss of control.

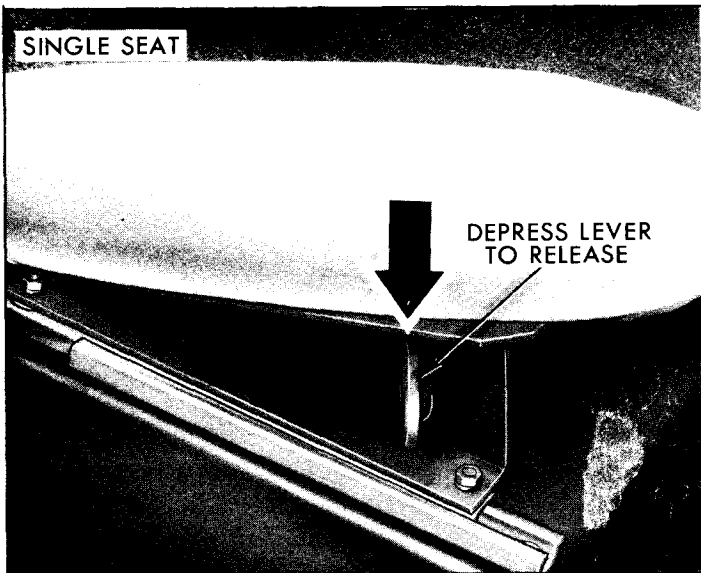

*Seat Swivel Mechanisms*

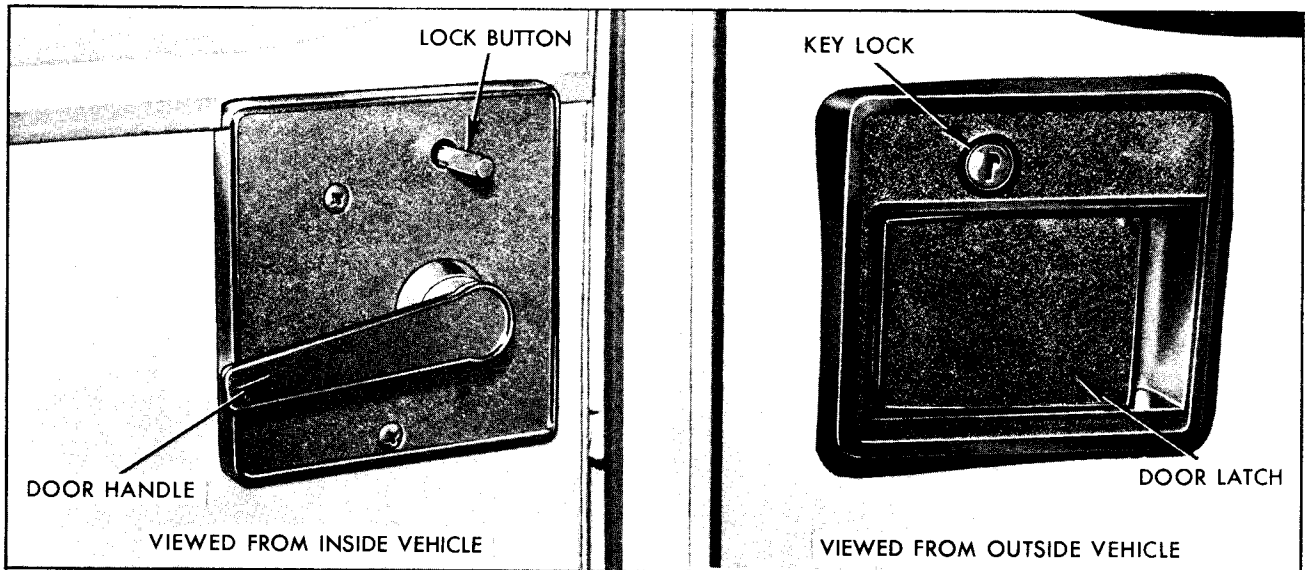

*Type 1 Door Latch*

## KEYS

Two sets of keys are furnished with your Motor Home. These keys are for the locks in the ignition switch, entrance door, glove box, external utilities compartment, and living area water tank filler cap. The code number of the ignition switch key is stamped on the "knock out" plug in the key head. Your dealer removed this plug and placed it with the spare keys in the special key envelope that was given to you at the time of delivery. For your protection record the number on this plug and the numbers on the other keys. Keep these numbers in a safe place, such as your wallet, **NOT IN THE VEHICLE**. In the event the original keys are lost, duplicates can be made by your dealer or a locksmith using the key code information. When leaving the vehicle unattended, remove the keys and lock the entrance door.

## ENTRANCE DOOR

### TYPE 1 DOOR LATCH

Door must be locked from outside the vehicle by inserting the key into the door key lock and turning. To unlock, turn in the counterclockwise direction. Reverse the direction to lock.

To lock door from inside the vehicle, push lock button IN. To unlock and open door from inside, pull the locking button OUT and lift or push down on inside door handle.

### TYPE 2 DOOR LATCH (Illustrated on Next Page)

The entrance door may be locked from outside the vehicle by inserting the key into the door key lock and turning. To unlock, turn in the counterclockwise direction. Reverse direction to lock.

To lock the door from inside the vehicle, push the left lock knob toward the rear of the vehicle (to the right). To unlock and open door from the inside, pull the left locking knob toward the front of the vehicle (to the left) and lift or push down on inside door handle.

All models have as a standard safety feature overriding door locks. When locked, the door latch mechanism is inoperative, preventing inadvertent opening of the door by movement of the inside handle.

The Type 2 door latch of the Motor Home also has a "dead bolt" lock that is used as a secondary lock.

**REMINDER: Always lock entrance door when driving for greater security in the event of an accident, to help keep children from inadvertently opening door, and for security against entry by unwelcome persons while momentarily stopped.**

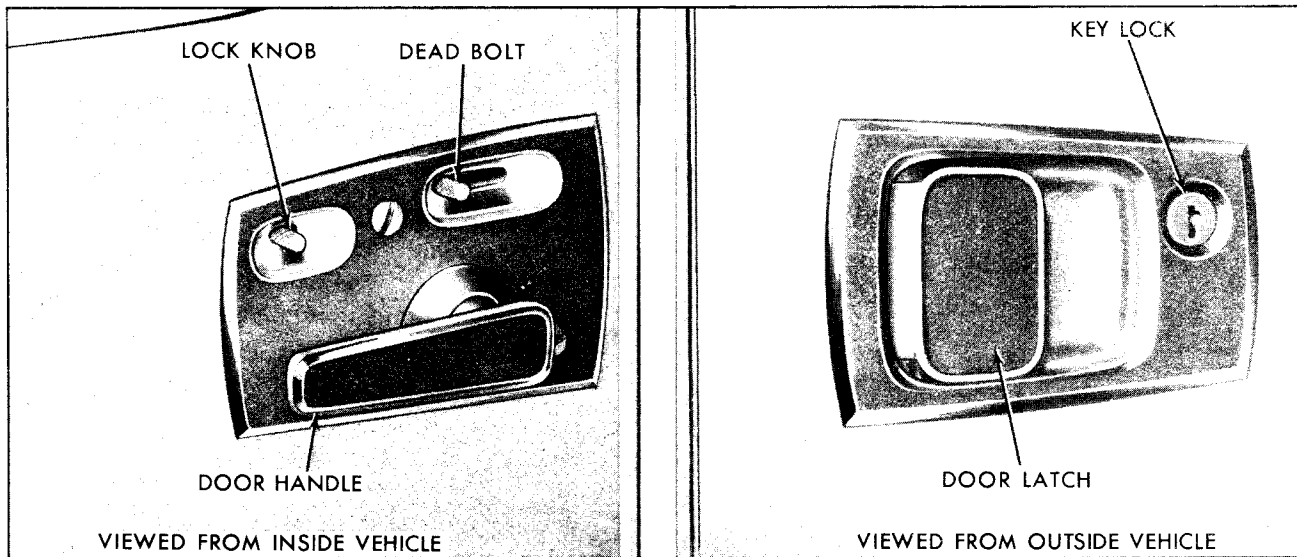

*Type 2 Door Latch*

## LAP BELTS

Your GMC Motor Home is equipped with lap belts in the driver and front passenger seating position(s), as well as certain other seating locations in the Motor Home. It is recommended that while the vehicle is in motion, all occupants remain seated and keep lap belts buckled snugly at all times.

**The front outboard seating positions**—have retractors which are designed to automatically take up excess webbing and maintain tension on the lap belt.

- Adjust seat to desired position and sit erect and well back in the seat.
- In a single motion, pull webbing across lap far enough to permit inserting metal latch plate end of lap belt into the buckle, until a snap is heard. If webbing is not pulled out far enough to reach the buckle, let the belt rewind into the retractor to release lock mechanism, so belt can be pulled out to the proper length.
- Position belt across lap as **LOW ON HIPS** as possible. To reduce the risk of sliding under the belt during an accident, adjust to a **SNUG FIT** by pulling belt firmly across lap in direction of retractor so it can take up slack.

**NOTE:** Take care not to let the lap belt twist while it is being rewound into the retractor. The bulk of the twisted belt may cause the retractor to jam so it will not rewind further,

while at the same time the retractor's locking mechanism prevents the belt from being withdrawn. If a belt should become jammed, you may be able to release it by pulling the belt out far enough to untwist it. Otherwise the retractor will require servicing.

**Lap belts at seating positions other than the front outboard positions**—should be positioned and secured as above, and adjusted to a **SNUG FIT** by pulling on the end of the belt extending from the adjustable latch plate.

- To lengthen the lap belts at these seating positions, place adjustable latch plate at right angle to the belt webbing and pull on latch plate; belt should then slide easily through the adjustment feature.
- To unfasten seat belts, depress push button in center of buckle.

## CAUTION

**A snug fit and a low lap belt position are essential to lessen the chance of injury in the event of an accident, because this spreads the force exerted by the lap belt in a collision over the strong hip bone structure rather than across the soft abdominal area. To lessen the chance of injury in the event of an accident—never use the same belt for more than one person at a time; avoid wearing belts in a twisted condition; do not allow belts or buckles to become pinched between the seat structural (metallic) member or in the door.**

## LAP BELT INSPECTION

- Periodically inspect belts, buckles, retractors, and anchors for damage that could lessen the effectiveness of the restraint system.
- Keep sharp edges and pointed objects away from belts.
- Replace belts if cut, weakened, frayed, or subjected to collision loads.
- Check that the anchor mounting bolts are tight.
- Have questionable parts replaced.
- Keep belts clean and dry.
- Clean only with mild soap solution and lukewarm water.
- Do not bleach or dye belts since this may severely weaken them.

## CHILD RESTRAINT

Children in vehicles should be restrained to lessen the risk of injury in accidents, sudden stops or other hazardous situations. In using any infant or child restraint system, read and comply with all installation and usage instructions.

All unused seat belts near the child should be stowed properly to help prevent them from striking him in the event of an accident. Lap belts without storage provisions should have buckles latched and belts adjusted to remove slack.

## VEHICLES NOT EQUIPPED WITH SPECIAL CHILD RESTRAINTS

If a child is traveling in a vehicle not equipped with a safe infant or child restraint system, the following precautions should be taken:

1. Infants unable to sit up by themselves should be restrained by placing them in a covered, padded bassinet placed crossways in the vehicle (widthwise) on the rear-facing dinette seat. The bassinet should be securely restrained with the regular vehicle lap belts.

2. Children able to sit up by themselves should be placed on a seat and lap belted. Never allow a child to stand or kneel on any seat or elsewhere in the vehicle, once it is underway.

3. A child who can sit up by himself but cannot see out the window should sit on a firm cushion with the regular lap belt restraining him at the hips. The cushion should be as firm as practical and just high enough to enable the child to look horizontally out of the window. The use of a cushion should be discontinued as soon as the child is old enough to see out of the windows without it.

4. It is recommended that children be restrained properly at all times when riding.

## OPERATION IN FOREIGN COUNTRIES

Your vehicle's engine is designed to operate on fuel of approximately 91 research octane number or higher, commonly sold in the United States or Canada.

If you plan to operate your vehicle outside the continental limits of the United States or Canada, there is a possibility that the best fuels available are so low in anti-knock quality that excessive knocking and serious engine damage may result from their use. To minimize this possibility, write to GMC Truck & Coach Division, General Motors Corporation, Pontiac, Michigan 48053 (or in Canada write to General Motors of Canada Limited, Owner Relations Department, Oshawa, Ontario), giving:

- The vehicle identification number (from plate attached to right side of dash panel or from the registration slip or title).
- The country or countries in which you plan to travel.

You will be furnished information on the quality of fuels available in the countries in which you plan to travel. It is recommended that you not operate your Motor Home in any country not having fuels meeting the requirements of your vehicle engine. Engine modifications are not available to compensate for low anti-knock quality fuels. Operation of your vehicle under conditions of continuous or excessive knocking constitutes misuse of the engine for which the manufacturer is not responsible under the terms of the New Vehicle Warranty.

## TRAILER HAULING

The Motor Home is designed and intended to be used primarily as a recreational vehicle. Towing a trailer will affect handling, durability and economy. Maximum safety and satisfaction depends upon proper use of correct equipment and avoiding overloads and other abusive operation.

The maximum loaded trailer weight which the Motor Home can pull is 2,000 pounds. GMC DOES NOT RECOMMEND TOWING ANY TRAILER UNLESS THE MOTOR HOME IS PROPERLY EQUIPPED. Information on trailer hauling capabilities, special equipment required, and available equipment offered can be obtained by writing to GMC Truck & Coach Division, General Motors Corporation, Technical Service Department, Pontiac, Michigan 48053. (Or in Canada by writing to General Motors of Canada Limited, Owner Relations Department, Oshawa, Ontario.)

To assist in attaining good handling of the Motor Home-Trailer Combination, it is important that the trailer tongue load be maintained at approximately 10% of the loaded trailer weight. Tongue loads can be adjusted by proper distribution of the load in the trailer, and can be checked by weighing separately the loaded trailer and then the tongue.

When towing trailers, tires should be inflated to the highest inflation pressures shown on tire placard located on glove box door. The allowable passenger and cargo load (GVW) of this vehicle is reduced by an amount equal to the trailer tongue load on the trailer hitch. Refer to page 1 for further information on vehicle loading.

## MAINTENANCE

More frequent Motor Home maintenance is required when being used to pull a trailer. Refer to "SERVICE and MAINTENANCE" section in this manual.

## BREAK-IN SCHEDULE

In addition to the "New Vehicle Operating Speeds" given later in this section, it is recommended that your new Motor Home be operated for 500 miles before trailer towing. If it is necessary to tow during this period, avoid speeds over 50 MPH, and full throttle starts.

## CAUTIONS

1. Trailer brakes are required on trailers over 1,000 lbs. loaded weight.
2. DO NOT tap into vehicle's hydraulic brake system if operation of the trailer brake system requires more than 0.02 cu.-in. of fluid displacement from the vehicle's master cylinder. The Motor Home's master cylinder fluid capacity will not be sufficient to operate both vehicle and trailer brakes under all conditions of use if more than 0.02 cu.-in. of fluid displacement is required.
3. Whenever a trailer hitch is removed, be certain to have any mounting holes in underbody properly sealed to prevent possible entry of exhaust fumes, dirt or water. (See "ENGINE EXHAUST GAS CAUTION" in the following section.)

## TRIP TIPS

A small amount of preparation prior to a trip will save a lot of time when traveling.

When loading heavy items into your Motor Home try to store them as low and centrally as possible. This will aid performance and handling of the vehicle. Remember even though an item may not weigh much individually the sum weight of several of these articles may be substantial.

## CAUTION

When transporting luggage or other cargo in your Motor Home it is recommended that all articles be secured in place. This precaution will help prevent such items from becoming projectiles in the event of an accident and possibly causing serious personal injury or property damage.

The following emergency equipment is recommended, at minimum:

- Fire Extinguisher
- Hydraulic Jack and Lug Wrench
- Spare Tire
- Flashlight
- First Aid Kit
- Road Emergency Flares
- Basic Tool Kit

These items might be found useful:

- Plastic Bucket and Funnel
- Water Hose and "Y" Connection, in case of two units on one water system
- Level
- Shovel
- Spare Automotive Fuses and Bulbs
- 2" x 4" Chocks or Blocks

The following checks should be made before starting on a trip:

#### **OUTSIDE VEHICLE**

1. Run through "Driver Check List" at the beginning of this section.
2. Check engine oil level.
3. Check fluid levels on all batteries.
4. Visually inspect radiator coolant level.
5. Fill windshield washer reservoir.
6. Check tire pressure, and inspect tires for road damage, foreign objects.
7. Check operation of all outside lights.
8. Check that all exterior vents are unobstructed.
9. Check and empty holding tank.

#### **INSIDE VEHICLE**

1. Check operation of optional Power Level System.
2. Check gasoline supply.
3. Check transmission fluid level.
4. Check power steering fluid level.
5. Check operation of windshield wipers and windshield washers.
6. Check operation of brakes.
7. Check operation of interior lights.
8. Check all appliances and fixtures for proper operation.
9. Check operation of motor generator.
10. Check and fill living area water system
11. Check and fill LP gas tank.
12. Check "Complete Vehicle Maintenance Schedule" to make sure all periodic maintenance and safety checks have been performed.
13. After the vehicle has been loaded, check to see that the vehicle's Gross Vehicle Weight, and front and rear axle capacities have not been exceeded. This check should be made fully loaded including passengers. (Refer to the "IMPORTANT INFORMATION ON VEHICLE LOADING" section of this manual for further information.)

Before leaving any camp-site make sure all litter has been picked up.

When traveling in winter it is recommended that the water tank not be filled until the destination is reached. This will ensure that the vehicle has thoroughly warmed up. The water and holding tank systems should be drained before leaving for home. Also, at this time, put some non-toxic, non-flammable anti-freeze into the sink and shower traps. Heat tape has been found useful in preventing pipe freeze-up, where power is available. Some non-toxic, non-flammable anti-freeze in the holding tank will help keep the tank contents from freezing. The recirculating toilet should be drained immediately at the end of the trip.

#### **DRIVING TIPS**

The Motor Home driver controls are automotive-type to make the vehicle as comfortable as possible. The steering and braking controls are power assisted to help make driving as effortless as possible. However, it must be remembered that the Motor Home is much higher, wider, and heavier than a family automobile.

Since the Motor Home is 9-ft. 4-in. high, with the roof mounted air conditioner, additional care is required to watch for low bridges and over-passes. **TREE BRANCHES CAN DO CONSIDERABLE DAMAGE TO THE WINDSHIELD OR ROOF OF THE VEHICLE TOO, SO WATCH FOR THEM.**

The Motor Home power-to-weight ratio is lower than that of the average automobile. Therefore it is essential to compensate for less acceleration when moving into traffic, or when passing another vehicle.

#### **NEW VEHICLE OPERATING SPEEDS**

Driving speeds for your new Motor Home should be limited to a maximum of 50 MPH for the first 100 miles, and 65 MPH for the next 400 miles with no heavy throttle accelerations. If your initial mileage is of the around-town variety, which is considered "severe service" especially in cold weather, be sure to include some 25 to 50 mile highway trips during the break-in period and vary the vehicle's speed.





# STARTING AND OPERATING VEHICLE

## ENGINE EXHAUST GAS CAUTION (CARBON MONOXIDE)

Avoid inhaling exhaust gases because they contain carbon monoxide, which by itself is colorless and odorless. Carbon monoxide is a dangerous gas that can cause unconsciousness and is potentially lethal.

If, at any time, you suspect that exhaust fumes are entering the Motor Home from any source have the cause determined and corrected as soon as possible. If you must drive before the cause is corrected, drive only with ALL except two rear windows FULLY open.

The best protection against carbon monoxide entry into the vehicle body is a properly maintained engine exhaust system, body and body ventilation system. It is recommended that the exhaust system and body be inspected by a competent mechanic:

- Each time the vehicle is raised for lubrication or oil change.
- Whenever a change is noticed in the sound, alignment, or appearance of the exhaust system.
- Whenever the exhaust system, underbody or rear of the vehicle is damaged.

See your "Complete Vehicle Maintenance Schedule" for inspection procedure.

To allow proper operation of the vehicle's ventilation system, keep front inlet grille clear of snow, leaves, or other obstructions at all times.

**SITTING IN A PARKED VEHICLE WITH ENGINE RUNNING FOR AN EXTENDED PERIOD OF TIME IS NOT RECOMMENDED.**

Do not run engine in confined areas such as garages any more than needed to move vehicle in or out of area. When vehicle is stopped in an UNCONFINED area with the engine running for any more than a short period of time, adjust heating or cooling system to force outside air into the vehicle as follows:

1. On vehicles not equipped with automotive air conditioning, set fan to medium or high speed and upper control lever to any position except "OFF." Lower control lever should be adjusted to any position except extreme left "RECIRC."

2. On vehicles equipped with automotive Air Conditioning, set fan to medium or high speed, upper control lever to any position except "OFF," and lower control lever to any position except extreme left "RECIRC."

The two rear windows should be closed while driving to avoid drawing dangerous exhaust gases into the vehicle through those openings. In addition, it is recommended that roof vent(s) be closed while driving. If, for some reason, a rear window or roof vent must remain open for a period while driving, or electrical wiring or other cable connections to a trailer must pass through the seal between them and the body, the following precautions should be observed.

- Close all windows.
- Adjust heating or cooling system to force outside air into the vehicle as described in Step 1 or 2 above but with fan set at high speed.
- Air vents in the instrument panel should be fully open.

It is important that the inside engine cover be properly seated to prevent possible leakage of exhaust fumes into the vehicle through this opening.

See "LIVING AREA FACILITIES CAUTION (CARBON MONOXIDE)" on page 29.

# STEERING COLUMN CONTROLS

## ANTI-THEFT STEERING COLUMN LOCK

The anti-theft ignition switch, located on the right side of the steering column, has five positions:

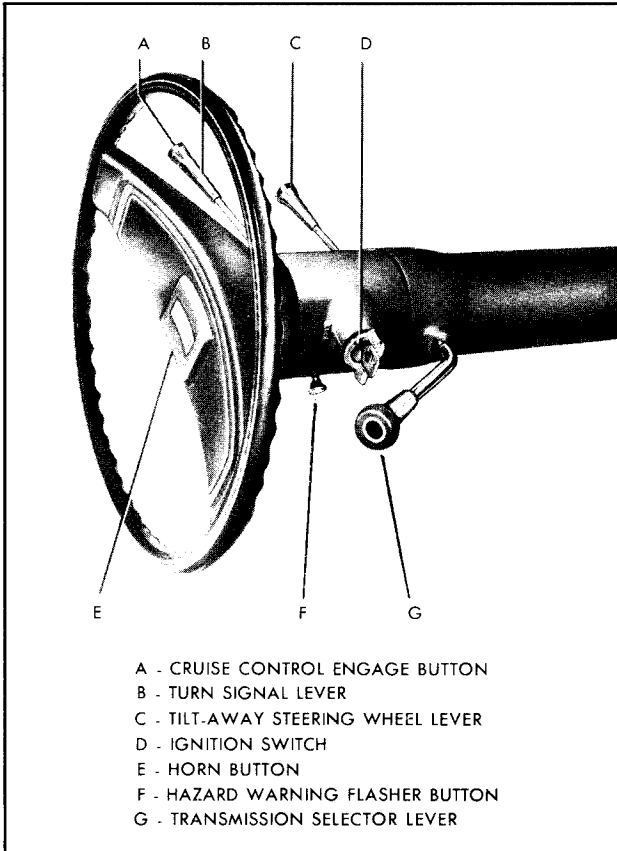

*Steering Column Controls*

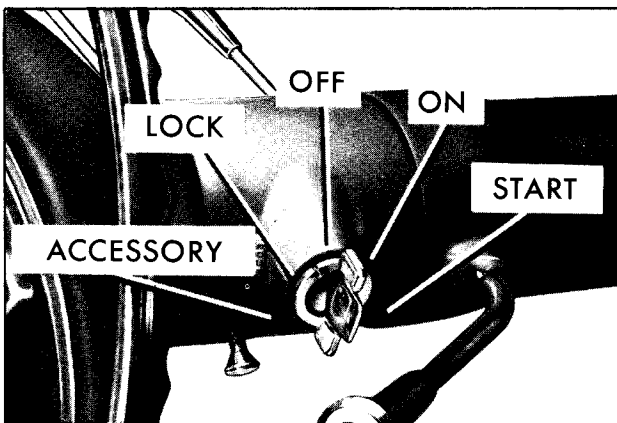

*Anti-Theft Steering Column Lock*

- **ACCESSORY**—Permits operation of electrical accessories when the engine is not running. To engage, push key in and turn toward you (counterclockwise).
- **LOCK**—Normal parking position, locks ignition and provides added theft protection by preventing normal operation of steering wheel and shift controls. Key cannot be turned to “LOCK” position and removed until transmission is placed in “PARK.”
- **OFF**—Permits turning engine off without locking steering wheel and shift controls.
- **RUN**—Normal operating position.
- **START**—Permits engagement of starter.

**NOTE:** The anti-theft steering column lock is not a substitute for the parking brake. Always set the parking brake when leaving the driver's seat unattended.

## PARKING

When leaving the driver's seat unattended:

- **SET PARKING BRAKE FIRST.**
- Place transmission selector lever in “PARK.”
- Turn key to **LOCK** position.
- Remove key from steering column lock (the buzzer will remind you).
- Lock entrance door if leaving vehicle.

## STARTING ENGINE

1. Apply the parking brake.
2. Place the transmission selector in “P” or “N” (“P” is preferred). A starter safety switch is designed to prevent starter operation while the transmission selector is in any drive position. (If it is necessary to re-start the engine with the vehicle moving, place the selector lever in “N”.)
3. Depress accelerator pedal and activate starter as outlined in the following, for different conditions.

## COLD ENGINE

Fully depress accelerator pedal and slowly release. With foot off the pedal, crank the engine by turning the ignition key to the "START" position—release when engine starts. If engine starts but fails to run, repeat this procedure. When engine is running smoothly (approx. 30 seconds) the idle speed may be reduced by slightly depressing the accelerator pedal and then slowly releasing.

### CAUTION

Extended running of the engine (5 minutes or more) without depressing the accelerator pedal, could cause damage to the engine or exhaust system due to overheating.

## WARM ENGINE

Depress accelerator pedal about halfway and hold while cranking the engine.

## EXTREMELY COLD WEATHER (BELOW 0° F.) OR AFTER VEHICLE HAS BEEN STANDING IDLE FOR SEVERAL DAYS

Fully depress and release accelerator pedal two or three times before cranking the engine. With foot off the accelerator pedal, crank the engine by turning the key to the start position—release key when engine starts.

### IF ENGINE FAILS TO START:

- First, fully depress and release the accelerator pedal several times, then remove foot from accelerator pedal and crank engine.
- If engine still does not start, fully depress the accelerator pedal and hold to the floor while cranking the engine.
- If the engine has been flooded with gasoline, it may start to run but not have enough power to keep running. In this case, continue cranking with the accelerator pedal fully depressed until the engine cleans itself of excess gasoline and runs smoothly.
- If engine doesn't crank properly due to a discharged main battery (automotive battery), place the battery switch in the "BAT BOOST" position. Return the switch to the "BAT NORMAL" position when engine starts.

**NOTE:** Do not continue cranking the engine for more than 30 seconds at a time to prevent starting overheating.

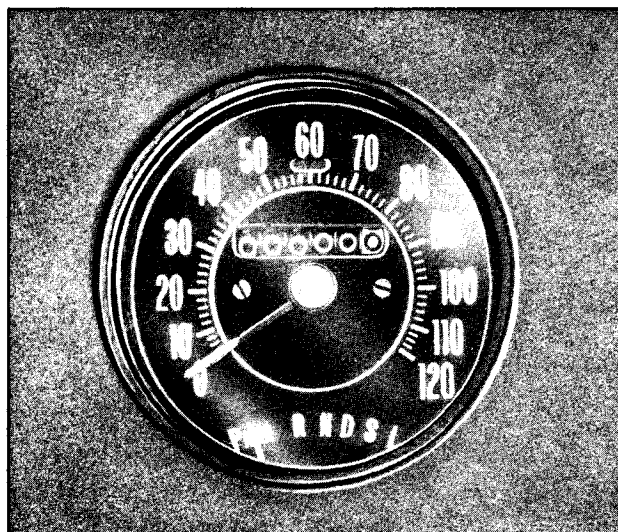

*Transmission Shift Indicator  
and Speedometer*

## AUTOMATIC TRANSMISSION

The transmission selector lever is located on the right side of the steering column and the shift indicator is located in the bottom section of the speedometer cluster on the dash.

- "PARK"—Transmission lock when parking or while starting the engine. Pull the selector lever towards you to select or release this position. Never move the selector lever to "PARK" position unless the vehicle is completely stopped. "NEUTRAL" is the only other position in which your Motor Home may be started.
- REVERSE "R"—For backing the Motor Home. Bring the vehicle to a complete stop before moving the selector lever into Reverse.
- NEUTRAL "N"—The out-of-gear position. It is provided for starting a stalled engine while the Motor Home is in motion or running the engine while standing with brake applied. **DO NOT COAST IN NEUTRAL.**
- DRIVE RANGE "D"—The driving range for city and highway driving. This position permits the transmission to operate through its complete range of gear ratios and to select automatically the proper ratio for road and load conditions.
- SUPER RANGE "S"—Used when super performance is needed for increased acceleration in traffic, hill climbing, or "Engine Braking"

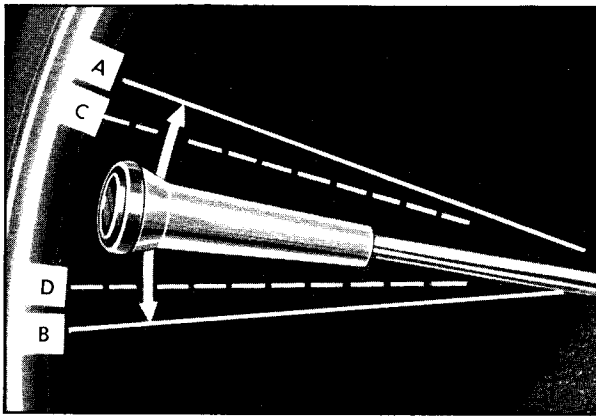

*Turn Signal Lever*

down-hill. The selector lever may be moved from "D" to "S" and vice versa, under most operating conditions. "SUPER" should not be used at speeds above 75 MPH.

- **LOW "L"**—Available for heavy pulling through mud or sand and for engine braking when descending steep hills. The selector lever may be moved to "L" at any speed but the transmission will only shift automatically into Low range when the vehicle speed is under approximately 40 MPH. The transmission will not upshift from Low range as long as the selector lever is in the "L" position.

#### **CAUTION**

**Before descending a steep or long grade—down a mountain or hillside—reduce speed and shift into a lower range. Under such conditions, use the brakes sparingly to prevent them from overheating—which reduces brake effectiveness. Use caution when shifting into lower range or lower gear on slippery surfaces with vehicle moving—the abrupt engine braking action could cause the front wheels to skid.**

- **FORCED DOWNSHIFT** — When additional acceleration is desired to pass moving vehicles or to climb steep grades at speeds between approximately 35 and 65 MPH, the transmission can be downshifted by depressing the accelerator pedal completely to the floor. It is also possible to obtain a forced downshift in "DRIVE" range at speeds under 35 MPH by depressing the accelerator pedal part way down.

## **TURN SIGNAL AND LANE CHANGE FEATURE**

Whenever a right or left turn is intended, when changing lanes, or when pulling away from the curb, use the turn signals.

- **FULL TURN** — For normal turns, move the turn signal lever to position "A" for right turn and "B" for left turn. Lever will remain in position without manual effort until the turn is completed, then cancel automatically.
- **LANE CHANGE** — Move lever to the detent position "C" for change to right lane or to "D" for change to left lane. Hold lever in position until lane maneuver is completed, then release. Lever will return to "OFF" position.

## **HAZARD WARNING FLASHER**

For operation of hazard warning flasher, see "In Case of Emergency" later in this manual.

## **HORN CONTROL**

The horn is actuated by depressing the rectangular shaped GMC button located in the center of the steering wheel.

## **POWER STEERING**

If the steering system power assist fails due to some malfunction, or because the engine has stalled, the Motor Home can still be steered. However, much greater effort is required, particularly in sharp turns.

## **TILT STEERING WHEEL**

The optional tilt steering wheel can be tilted up above normal position to provide additional room for entrance and exit as well as selected driving positions above or below normal height.

The tilt mechanism is operated by lifting up on the small control lever, on the left side of the steering column just below the directional signal lever, then moving the steering wheel to the selected position and releasing the lever.

## CRUISE CONTROL

The optional Cruise Control is an automatic speed control system which is designed to allow the vehicle to hold a selected speed of approximately 30 MPH or higher—depending on engine limitations—thus increasing comfort and economy on turnpikes, and other non-congested highways.

- **TO OPERATE** — The Cruise Control engagement button is located in the end of the turn signal lever. Accelerate the vehicle to the desired speed and momentarily push in the engagement button, take your foot off the accelerator and this speed will be maintained.
- **TO RESET AT A FASTER SPEED** — Accelerate the vehicle to the desired higher speed, push in the engagement button fully and release slowly.
- **TO RESET AT A SLOWER SPEED** — Depress the engagement button fully and **HOLD**. Allow vehicle to decelerate. When vehicle reaches desired speed, release the engagement button slowly.
- **FOR PASSING** — You can increase your speed by depressing the accelerator pedal. When you remove your foot from the pedal, the vehicle will slow down to the cruising speed set prior to the acceleration.
- **TO DISENGAGE** — Lightly apply the brake pedal to disengage system.

### CAUTION

**DO NOT** use the Cruise Control when conditions are not suitable for maintaining a constant speed, such as in heavy or varying traffic, or on winding or slippery roads. With the Cruise Control engaged, releasing the accelerator pedal does not permit engine speed to return to idle.

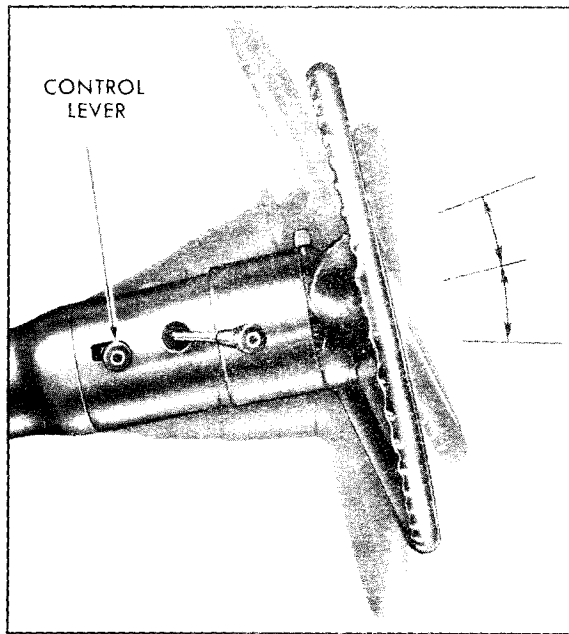

*Tilt Steering Wheel*

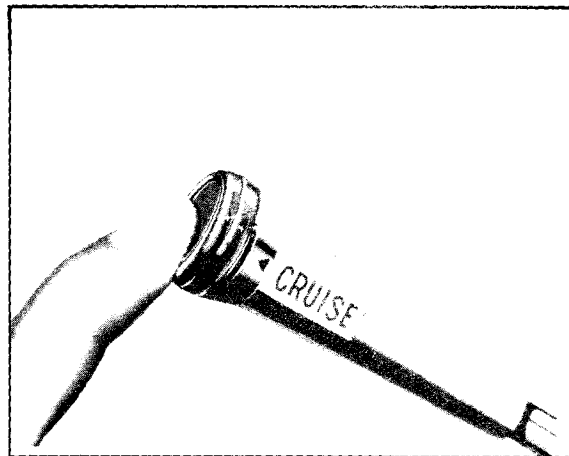

*Cruise Control Lever*

## FLOOR CONTROLS

### BRAKE SYSTEM

The Motor Home is equipped with a Dual Hydraulic Split System With Power Assist. It is also equipped with disc type brakes on the front wheels and drum type brakes on the tandem rear wheels.

It is designed so that half of the brake system will provide some braking action in the event of a hydraulic leak in the other half of the system.

### CAUTION

Driving through deep water may wet the brakes and adversely affect brake performance so that the vehicle will not slow down at the usual rate. Applying the brakes lightly will indicate whether they have been so affected. To dry them quickly, lightly apply the brakes while maintaining a safe forward speed with an assured clear distance ahead until brake performance returns to normal.

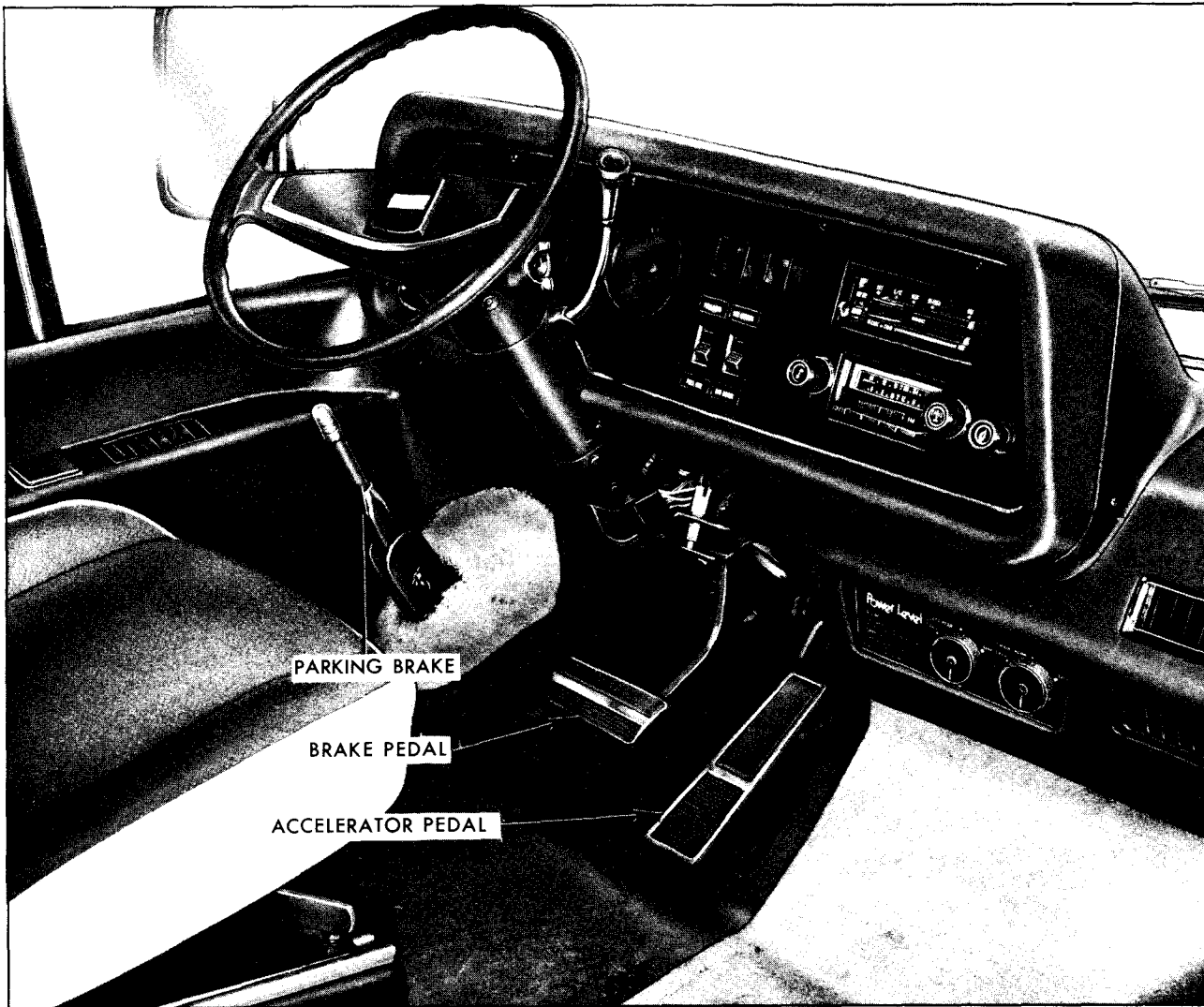

*Motor Home Floor Controls*

- On your Motor Home, if power assist to the brakes is interrupted due to a stalled engine or some malfunction, two or more brake applications can normally be made using the built-in reserve power.
- If the brake pedal is held down, the system is designed to bring the vehicle to a full stop on reserve power. However, the reserve power is partially depleted each time the brake pedal is applied and released if the engine is inoperative.
- When reserve power is exhausted, the vehicle can still be stopped by applying greater force to the pedal.

#### **AUTOMATIC BRAKE ADJUSTERS**

Brakes on this Motor Home (except for the Parking Brake) are self-adjusting, designed to eliminate periodic adjustments.

Drum brake adjustments are made automatically as the brakes are applied while Motor Home is moving backwards.

Disc brake adjustment is made automatically with each brake application.

- If excess brake pedal travel develops, drive alternately backward and forward several times and apply brakes firmly in each direction.

- See your service outlet if normal pedal travel is not restored, or if there is a rapid increase in pedal travel, which could be a sign of other brake trouble.

**NOTE:** "Riding The Brake" by resting your foot on the brake pedal when not intending to brake can cause abnormally high brake temperatures, excessive lining wear and possible damage to brakes.

**REMINDER:** The front disc brakes have a built-in wear indicator that is designed to make a warning noise when the linings are worn to where replacement is required. For further information on brake system maintenance refer to the **SERVICE AND MAINTENANCE** section.

### PARKING BRAKE

- To set parking brake, pull up the handle located on the floor against the left wall, below the instrument panel.
- For maximum holding power, depress regular brake pedal at the same time.
- To release parking brake push the handle down.
- As a reminder, the optional "PARK BRAKE" reminder light is designed to glow whenever the parking brake control is not fully released, and the ignition is on.
- Never drive vehicle with parking brake set as this may overheat or otherwise damage rear brakes.

The amount of force required to apply parking brake can be adjusted by turning a tension adjustment knob located at the upper end of the lever. This also adjusts the degree of brake application. The greater the force required at the lever the greater the degree of brake application.

**NOTE:** The parking brake should be set first whenever the driver's seat is left unattended.

If the vehicle is parked on a grade and the transmission is placed in "PARK" before the parking brake is set, the weight of the Motor Home may exert so much force on the parking pawl in the transmission than the transmission selector lever cannot later be pulled out of "PARK." To prevent this, the parking brake should be applied **BEFORE** moving the trans-

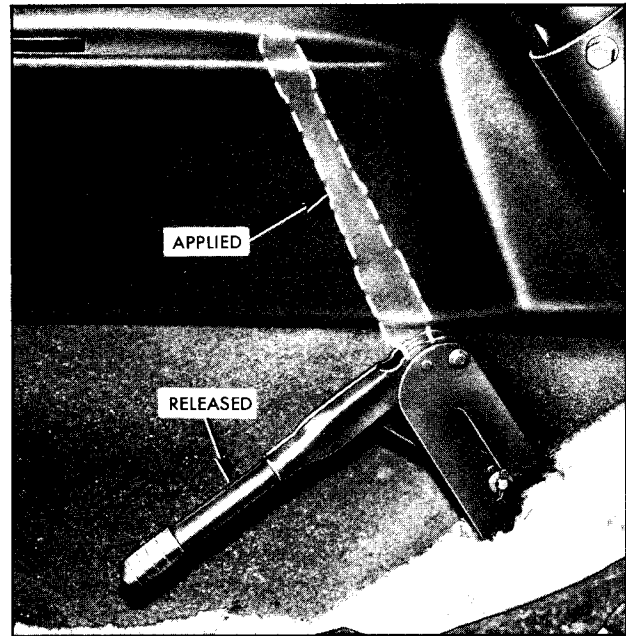

*Parking Brake Control*

mission selector lever to "PARK." When preparing to move the vehicle, the shift indicator should be moved out of the "PARK" position **BEFORE** releasing the parking brake. It is good driving practice to set the parking brake first, and release the transmission from "PARK" first at all times, even on the level. If "torque lock", as this condition is called, does occur, it may be necessary to have another vehicle nudge this vehicle up hill, to take some of the pressure off the transmission while the driver pulls on the transmission selector lever.

### HEADLIGHT DIMMER SWITCH

To obtain high or low beam headlights, push the foot dimmer switch located on the floor to the left of the brake pedal. Each time the switch is depressed, the light beam changes. A headlamp beam indicator, on the face of the speedometer, is designed to light up when the headlights are on high beam.

### HEADLIGHT "FLICKER"

The headlight circuits are protected by a circuit breaker in the light switch. An overload on the breaker will cause the lights to "flicker" on and off, or in some cases to remain off. If this condition develops, have your headlight electrical circuit checked immediately.



# INSTRUMENT PANEL AND CONTROLS

## SPEEDOMETER AND ODOMETER

The speedometer indicates the forward speed of the Motor Home in miles-per-hour. The odometer registers the accumulated mileage the Motor Home has been driven. Also, located in the speedometer cluster are the turn signal indicators which show direction and proper operation of the turn signals, the high beam indicator light, and the shift indicator.

## FUEL GAUGE

This gauge shows the approximate fuel level in the main tank when fuel selector switch is in the "FUEL MAIN" position, and the fuel level in the auxiliary tank when fuel selector switch is in the "FUEL AUX" position. The pointer will indicate the correct positions only when the ignition is in the "ON" position.

Since both fuel tanks are interconnected, the

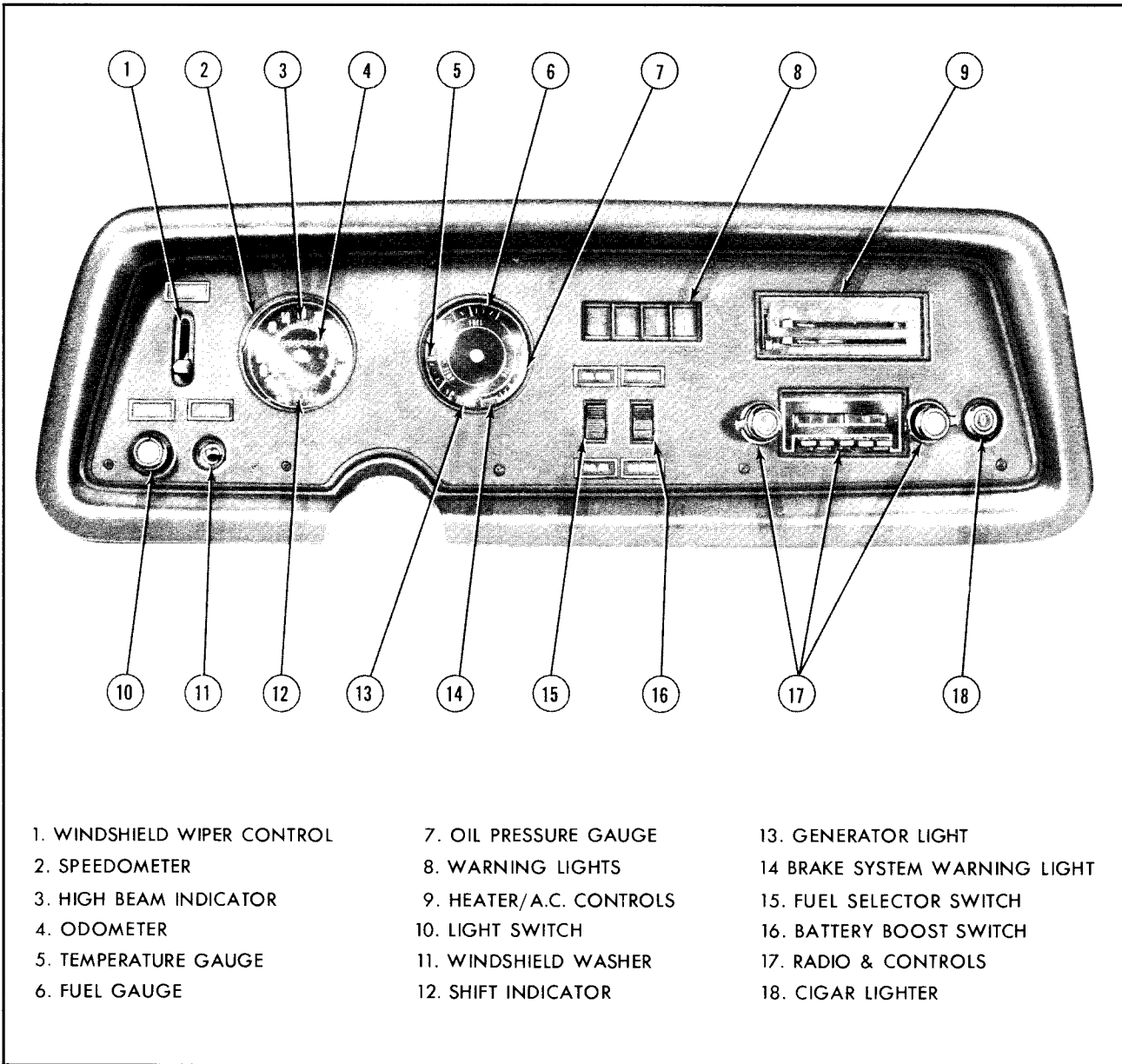

*Instrument Panel*

indicated level is designed to read the same (with the switch in either position) until approximately 60% of the total fuel capacity has been used. See "Fuel Selector Switch" later in this section.

## TEMPERATURE GAUGE

This gauge registers the temperature of the engine coolant. The center area of the water temperature gauge marks the normal operating range. However, if the needle moves beyond the center area marks into the "H" side or hot area of the gauge, stop the engine as soon as possible, and remain stopped until the cause of the overheating is determined.

## OIL PRESSURE GAUGE

This gauge registers engine oil pressure. The consistency of the oil in a cool engine will cause a high reading when the engine is first started. As the engine warms, the pressure will recede to normal. With the engine warmed up to normal operating temperature, minimum pressure at idle should be slightly above the "L" graduation (8 PSI). At normal operating speeds, minimum pressure should be between the second and middle graduations (35 PSI). Should the pressure drop below these minimums, stop the engine immediately and check the cause of the low oil pressure. This could be the result of a dangerously low oil level in the crankcase. Driving the vehicle with low oil pressure can cause extensive engine damage.

## CHARGING SYSTEM WARNING LIGHT

Located to the right of the temperature gauge is the charging system warning light. A red light "GEN" will appear with the ignition key in the "ON" position and the engine not running. This light lets you know the warning signal is operational. Should the light fail to come on, see your Motor Home service outlet. When the engine is started, the warning light should go out and remain out. If the light remains on when engine is running, have your service outlet locate and correct the trouble as soon as possible.

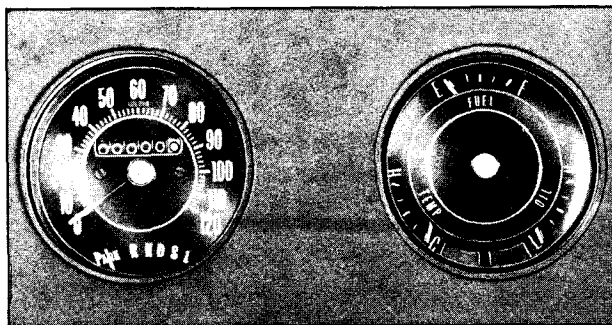

*Speedometer and Gauge Clusters*

## BRAKE SYSTEM WARNING LIGHT

The regular brake system is designed so that half of the brake system will provide some braking action in the event of a hydraulic leak in the other half of the system. If the red warning light, located to the left of the oil pressure gauge, glows continuously when the engine is running and after the brakes have been firmly applied, it may indicate that there is a malfunction in one half of the brake hydraulic system.

- As a check on bulb condition the light should glow during engine starting.
- Have system repaired if light does not come on during check.
- This warning light is not a substitute for the visual check of brake fluid level required as part of normal maintenance.

## WHAT TO DO IF LIGHT GLOWS RED:

1. Pull off the road and stop, carefully—remembering that:

- Stopping distances may be greater.
- Greater pedal effort may be required.
- Pedal travel may be greater.

2. Try out brake operation by starting and stopping on shoulder of road — then:

- If you judge such operation to be safe, proceed cautiously at a safe speed to nearest service outlet for repair, or
- Have vehicle towed to service outlet for repair.

Continued operation of the vehicle in this condition is dangerous.



*Warning Light Cluster*

## TELL-TALE WARNING LIGHT CLUSTER

A cluster of indicator lights is located just to the left of the heater controls. These are designed to inform the driver of the status of certain systems or conditions of which he should be aware. Among these are:

- “CRUISE” (Optional Equipment) – This indicator is designed to glow GREEN whenever the Cruise Control System is engaged and working.
- “DOOR” – The door light is designed to warn the driver that the entrance door is not properly closed.
- “PARK BRAKE” (Optional Light) – As a reminder, the “PARK BRAKE” brake reminder light is designed to glow whenever

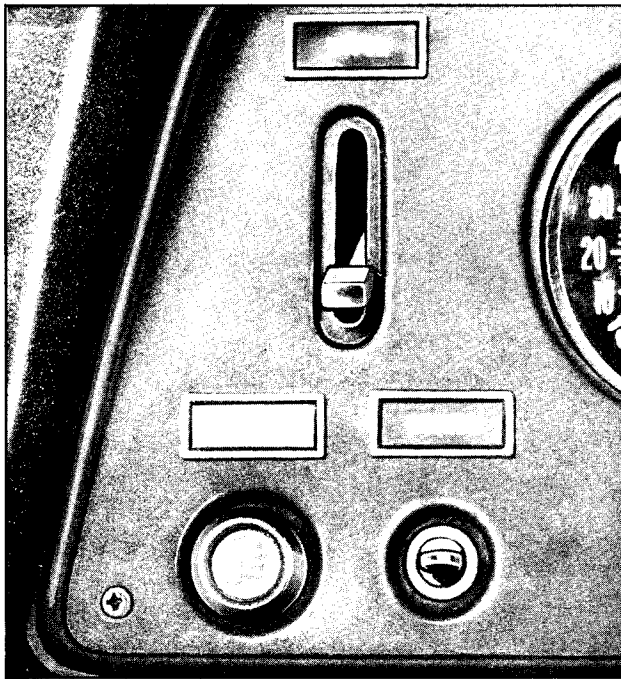

*Windshield Wiper, Washer,  
and Headlight Controls*

the parking brake control is not fully released and the ignition is on.

- “LOW FUEL” (Optional Light) – The low fuel warning light in your Motor Home is designed to come on when the main tank has less than five gallons of fuel left and the fuel selector switch is in the “FUEL MAIN” position. If, at any point after this, the fuel selector switch is changed to “FUEL AUX” the “LOW FUEL” warning light will then go out and come on again when the fuel in the auxiliary tank goes below five gallons. At this point both fuel tanks of your Motor Home are nearly depleted.
- “SET POWER LEVEL TO TRAVEL” (Optional Light) – This light is designed to inform the driver that the optional power level controls should be set to the “TRAVEL” position before driving the Motor Home (also a buzzer will sound for approximately 10 seconds). This will allow your Motor Home’s air suspension system to automatically maintain the proper suspension pressure while the vehicle is being driven. (See “Operation of Power Level System” later in this section.)

## HEADLIGHT SWITCH

The headlight switch serves four functions:

1. Pulling the switch half-way out provides parking lights, instrument panel lights, tail lights, side marker lights, and clearance and identification lights.
2. Pulling the switch all the way out provides all driving lights, – this includes headlights, plus those mentioned above.
3. To dim instrument panel lights, turn switch knob clockwise.
4. To operate the dome lights, turn switch knob fully counterclockwise.

## WINDSHIELD WIPER LEVER

The Motor Home windshield wipers are variable speed, and hydraulically powered. The lever control, on the left side of the instrument panel varies the speed of the wiper blades from stop (“DOWN” position) to fast (extreme “UP” position).

## WINDSHIELD WASHERS

The windshield washers are controlled by the washer switch located under the windshield wiper lever. To operate the washers, turn the wipers to an ON position, then push down on the switch until the desired amount of washer fluid has been directed to the windshield.

- Check washer fluid level regularly – do it frequently when the weather is bad.
- Use a fluid such as GM OPTIKLEEN to prevent freezing damage, and to provide better cleaning.
- Do not use radiator anti-freeze in windshield washer; it could cause paint damage.
- In cold weather, warm the windshield with defrosters before using washer – to help prevent icing that may seriously obscure vision.

## FUEL SELECTOR SWITCH

The fuel selector switch, located below the warning light cluster, has two positions—“FUEL MAIN” and “FUEL AUX.” This switch allows the driver to change the fuel pick-up and fuel gauge sending unit from the main tank, as it goes empty, to the auxiliary tank which will normally contain 7 to 9 gallons of fuel. It is recommended that any time the fuel system is filled, this switch be put in the “FUEL MAIN” position and left there until auxiliary fuel is needed.

## BATTERY BOOST SWITCH

The GMC Dual Battery System provides power from two batteries to the Motor Home 12-volt electrical system either in combination or singularly. The components used to provide charging and/or switching are conventional, except for a diode assembly with which both batteries will receive charging current whenever the vehicle is running. The diode assembly has separate outputs to the two batteries and provides isolation between the batteries and their associated circuits whenever the engine is not running.

The main battery (or automotive battery) supplies power to the chassis circuit; i.e., engine, external lights, etc. The auxiliary battery (living area battery) powers the Motor Home living area; i.e., internal lights, refrigerator, etc.

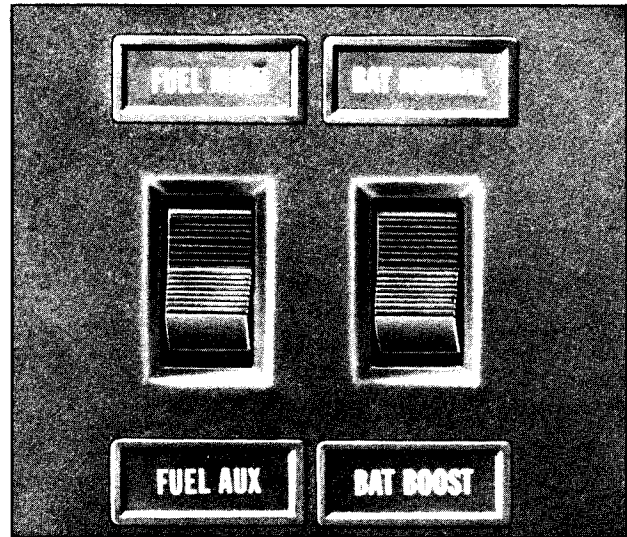

*Fuel Tank and Battery Switches*

The battery switch should be left in the “BAT NORMAL” position, except when additional power is needed for either battery circuit. If this is desired, change switch to “BAT BOOST” position. After use, it is recommended that switch be returned to the “BAT NORMAL” position.

**NOTE:** If the battery boost switch is left in the “BAT BOOST” position for extended periods this can result in both batteries being discharged.

The auxiliary (living area) battery will recharge itself whenever the motor generator is running, or whenever your Motor Home is connected to an external power source (see page 30), in addition to being recharged while the vehicle’s engine is running.

## CIGAR-CIGARETTE LIGHTER

Push the lighter in all the way to operate. When it is heated sufficiently to use, it is designed to “snap” back to normal position with noticeable sound. Avoid holding the lighter in by hand while it is heating.

For added safety, the cigar-cigarette lighter has a heat-sensitive terminal which is designed to melt and break the circuit if the lighter becomes overheated.

## HEATING SYSTEM (WITHOUT AUTOMOTIVE AIR CONDITIONER)

The heating system controls are located on the instrument panel to the right of the steering column. There are three separate controls;

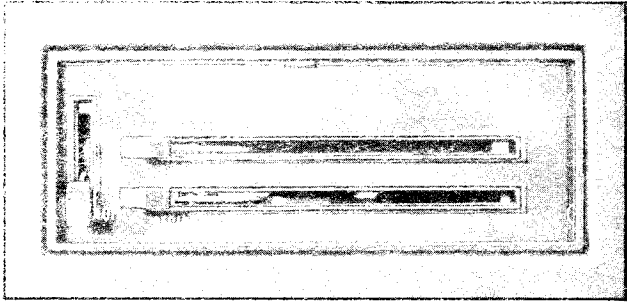

*Automotive Heating System Controls*

"FAN" lever to control speed of blower operation; "RECIRC.," "COLD," "HOT" lever to control temperature of air; "OFF," "VENT," "HEATER," "DEF" lever to control direction of air flow. The "FAN" lever works vertically and the other two levers work horizontally. The three levers may be placed in any combined position to deliver the climate conditions most desirable at any given time.

- "FAN"—The fan switch has four positions; "OFF" and three blower speeds ranging to "HI" and two unmarked positions between "OFF" and "HI." The fan will not operate unless the top lever has been moved from the "OFF" position, and in order to operate the fan in the "HI" position the engine must be running.
- "OFF," "VENT," "HEATER," "DEF"—With the lever in the "OFF" position the system is off. With the lever in the "VENT" position 100% outside air enters the driver's compartment. The air enters through the dash mounted outlets and through the heater outlets. Temperature of incoming air may be controlled by moving the "RECIRC.," "COLD," "HOT" (temperature) lever to desired position. Any one of the three blower speeds may be selected.

With the lever in the "HEATER" position, air will flow through the heater floor distributor outlet (with slight flow of air to the defroster outlet). For maximum heat, move temperature lever to "HOT" position and "FAN" switch lever to "HI" position. Heating system output can be varied by moving temperature lever and "FAN" lever to different positions.

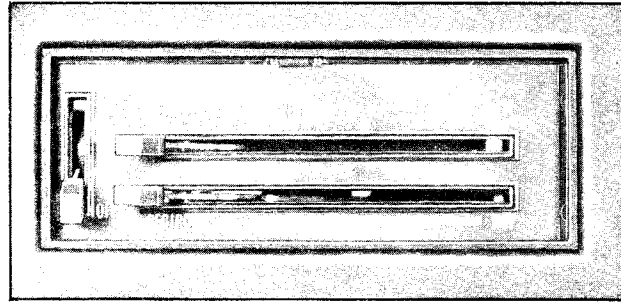

*Automotive Air Conditioner Controls*

With the lever in the "DEF" position, the system operates the same as in the "HEATER" position except most of the air flow will be through the defroster outlets at the windshield.

- "RECIRC.," "COLD," "HOT"—This lever, used in conjunction with the system selector lever ("OFF," "VENT," "HEATER," "DEF") and the "FAN" switch lever, will control the temperature of the output air being distributed.
- Clear windshield, rear window, outside mirror, and all side windows of ice and snow before driving vehicle.
- Operate blower on "HIGH" for a few seconds before moving the vehicle, to clear the air intakes of snow.

## AUTOMOTIVE AIR CONDITIONER

The Motor Home Air Conditioning System offers year-round driving comfort. In addition, to providing circulation of cool air during hot weather, the system can provide warm air in cold weather and dehumidify outside air in humid weather.

Combined air conditioning and heating system controls are located on the instrument panel in the upper right-hand corner. There are three separate controls; "FAN" lever, to control speed of blower; "OFF," "A/C," "VENT," "HEATER," "DEF" lever to control direction of air flow and which system is to be operated; "RECIRC.," "COLD," "HOT" lever to control the temperature of the air. The three levers may be placed in many combined positions to deliver the climate conditions most desirable at any given time.

- “FAN”—the fan switch has four positions; “OFF” and three blower speeds ranging from “LO” to “HI.” The fan will not operate unless the top lever has been moved from the “OFF” position, and in order to operate the fan in the “HI” position the engine must be running.
- “OFF,” “A/C,” “VENT,” “HEATER,” “DEF”—With the lever in the “OFF” position the system is off. With the lever in the “A/C” position (and the “RECIRC,” “COLD,” “HOT” lever at “RECIRC” position) the air conditioning system is activated. This position uses 100% recirculated air. This setting will provide maximum cooling. In combination with “A/C” setting moving the temperature lever to the “COLD” position provides 100% outside air. Further movement of the temperature lever to the right (toward “HOT” position) will heat the dehumidified air to the desired temperature. The “FAN” switch can be set to meet air flow requirements.

With the lever in the “VENT” position, 100% outside air enters the driver’s compartment. This setting is for use during periods of less severe heat and humidity, air flow is identical to air flow in “A/C” position, however, the air conditioning compressor is not operating. Temperature of incoming air may be controlled by moving the temperature lever to the desired position. Any one of the three blower speeds may be selected.

With the lever in the “HEATER” position, air will flow through the heater floor distributor outlet (with a slight flow of air to the defroster outlet). For maximum heat, move the temperature lever to “HOT” position and “FAN” switch lever to “HI” position. Heating system output can be varied by moving temperature lever and “FAN” lever to different positions.

With the lever in “DEF” position, system operates the same as in the “HEATER” position except most of the air flow will be through the defroster outlets at the windshield.

- “RECIRC,” “COLD,” “HOT”—This lever, used in conjunction with the system selector lever (“OFF,” “A/C,” “VENT,” “HEATER,” “DEF”) and the “FAN” switch lever, will control the temperature of the output air being distributed.

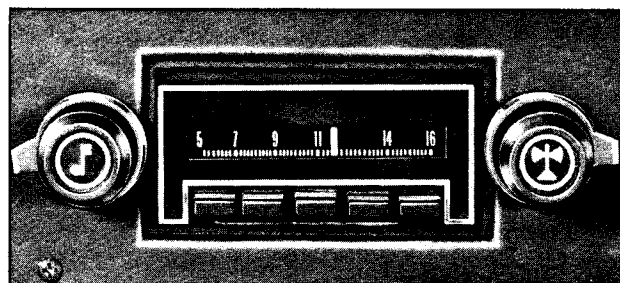

*Push Button AM Radio*

#### CAUTION

Operate in “DEF” position for 30 seconds before switching to “A/C.” This will remove humid air from the system and minimize rapid fogging of the glass which can occur if humid air is blown onto a cool windshield.

- Clear windshield, rear window, outside mirrors, and all side windows of ice and snow before driving vehicle.
- Operate blower on “HIGH” for a few seconds before moving the vehicle, to clear the air intakes of snow.

### RADIOS AND TAPE DECK

#### PUSH BUTTON “AM” RADIO

The “ON-OFF” switch is on the left-hand center knob with the volume control. The left-hand outside knob varies the tone response of the receiver. The right-hand center knob is used to select the station desired. The right-hand outside knob adjusts the front and rear speakers.

In addition to the manual controls, this radio provides five push buttons with which to automatically select pre-set stations. To pre-set, pull the push button “out” as far as it will go, tune in the desired station manually, and then push the button “in.”

Repeat this operation for each push button.

#### AM-FM RADIO

In addition to providing standard AM reception, this set permits you to receive clear static-free FM broadcasts. Move the slide bar, above the push buttons to the right or left to select AM or FM reception. All other controls remain the same as described for push button radios. FM broadcasts may be received as far as 25 miles from the sending station, depending on the

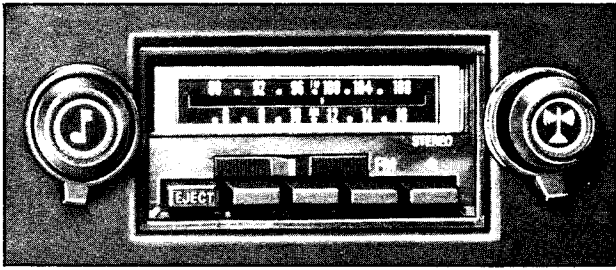

*AM-FM Stereo Radio with Tape Deck (Tape Removed)*

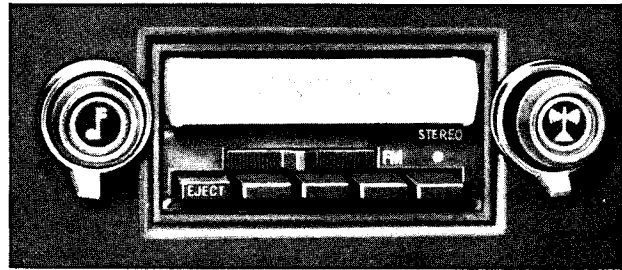

*AM-FM Stereo Radio with Tape Deck (Tape Installed)*

power of the station and the existing terrain. In fringe areas, it may be possible to retune the radio slightly to maintain peak reception. If not, retune to a closer or stronger FM station or switch to AM operation. Push buttons may be set for both AM or FM stations as follows:

- Place slide bar in AM position.
- Pull push button out as far as it will go, tune in desired AM station manually and then push button in to LOCK-IN position.
- Repeat for each remaining push button.
- Place slide bar in FM position and repeat procedures outlined for AM band setting.

**IMPORTANT:** Bands should not be changed if push button is unlocked or radio may be damaged.

#### **ANTENNA**

The radio antenna is mounted on top of the vehicle. If necessary, adjustments for maximum antenna effectiveness on AM can be made by your authorized GMC Motor Home service outlet.

#### **STEREO RADIO**

Stereo Receivers permit FM stereo reception with the AM-FM radio. Radio controls are used to turn the set on and off and for station selection. For most pleasing stereo effect, the speakers are criss-crossed, with the left front and right rear speakers reproducing the left channel, and the opposite speakers reproducing the right channel. Balancing the speakers is not required as this adjustment has been made at the factory. Should it become necessary to make this adjustment, see your GMC Motor Home service outlet. The indicator light will be on when the radio is tuned to an FM stereo station. Most broadcasts on such stations will be in stereo.

#### **To Tune Your Stereo Radio**

- Tune radio to an FM Stereo station (one which makes the indicator light come on with a steady glow).
- Tune the lever behind the station selector knob until volume from front and rear speakers sounds equal.
- Regulate volume and tone controls as required.

#### **STEREO TAPE SYSTEM**

The optional Stereo Tape Player provides prerecorded stereo programs for your enjoyment.

To play, insert cartridge through tape door with label side up and open end in first. Tape will play through all four programs in succession, then replay in same sequence. Balancing the speakers is not required as this adjustment has been made at the factory. Should it become necessary to make this adjustment, see your GMC Motor Home service outlet.

1. Rotate fader control until volume from front and rear speakers sounds equal.
2. Regulate volume control and tone controls as desired.
3. To change program track, push in volume control knob and release; player will index to next track.
4. Push in the "eject" button to remove tape cartridge from player.

#### **Cleaning and Care**

Every 100 hours of operation, or if tape slips and runs slowly, the capstan (revolving metal post), head and tape guide should be cleaned with a cotton-tipped swab moistened with alcohol (do not use carbon tetrachloride). To

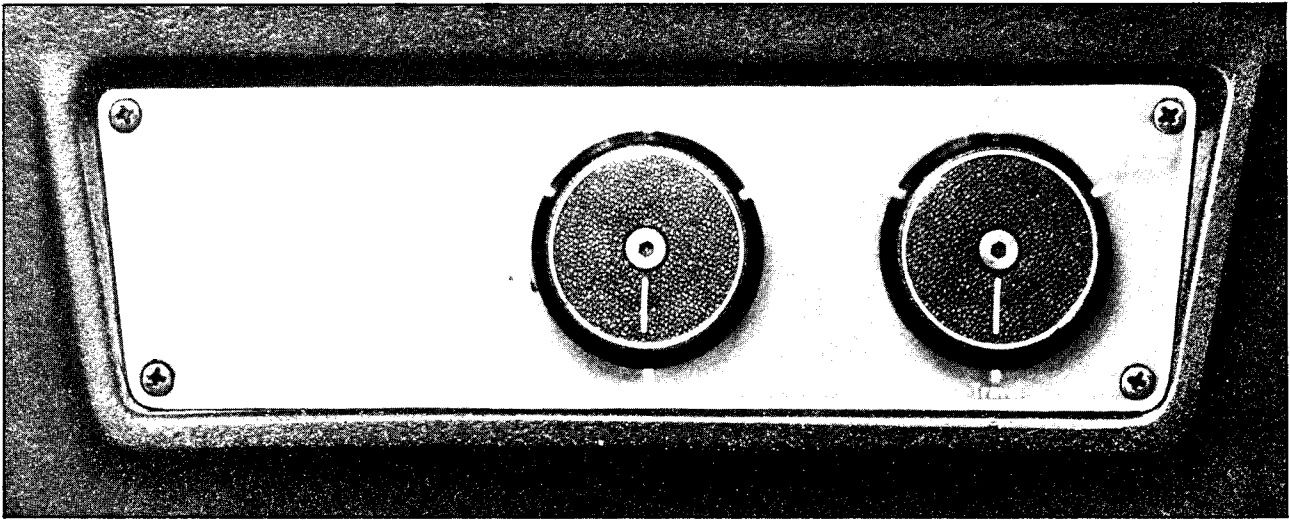

*Power Level System Controls*

clean the capstan, trip the "ON-OFF" switch at the rear of the receptacle with your finger and hold the swab against the rotating capstan.

**IMPORTANT:** When tape player is not in use, remove the cartridge and store it in a cool, dry place out of direct sunlight. If the cartridge is not removed, the radio may be inoperative and possible roller damage to the tape unit could occur.

### **MOBILE RADIO TRANSMITTERS**

Mobile radio transmitting equipment is subject to Federal Communications Commission regulations and must be installed by a qualified radio technician. The specific installation instructions for radio transmitters will vary depending upon the radio equipment used. Mobile telephone equipment installed by your local telephone company, citizens band radios and electronic garage door openers will not adversely affect vehicle operation. In the event any other type of mobile radio transmitter is to be installed, further instructions are required so that vehicle operation will not be adversely affected. Contact GMC Truck & Coach Division, General Motors Corporation, Technical Service Department, Pontiac, Michigan 48053 (or in Canada, contact General Motors of Canada Limited, Product Service Department, Oshawa, Ontario).

### **POWER LEVEL SYSTEM**

The optional Power Level System provides the ability to level the vehicle at campsite or parking area where the ground is not level. This system overrides the automatic leveling feature that maintains a constant ride height at the rear tandem suspension. The Power Level System can raise or lower the rear of the vehicle approximately 4 inches from normal ride height.

The Power Level Controls are located to the right of the steering wheel at the lower portion of the dash panel.

#### **NORMAL OPERATION**

The controls consist of two knobs labeled: "LEFT REAR" and "RIGHT REAR." Each knob has four positions and is used as follows:

"RAISE"—Knob in this position will raise rear of vehicle to any desired level, up to a maximum of 4 inches above normal ride height. When desired height is reached, turn indicator on knob to "HOLD" position.

"HOLD"—When indicator line on knob is turned to this position the appropriate side of the vehicle will remain at that height. This can be done after being either in the "RAISE" or "LOWER" position.

"LOWER"—With the indicator line in this position the appropriate side of the vehicle will lower a maximum of 4 inches below normal ride height. In order to maintain a desired height turn indicator on knob to "HOLD."



**TRAVEL**--Whenever driving vehicle on highways or improved roads place indicator line in **TRAVEL** position. This will automatically maintain a constant ride height at the rear (approx. 8-inch ground clearance at rear). A reminder light in the dash panel is designed to light any time the engine is running and the transmission selector lever is moved to **"D"** (Drive Range).

When using Power Level at a campsite the vehicle engine need not be running to operate the system, however, the ignition key must be in the **"ACCESSORY"** position.

A glass of water or a bubble type level when placed in a normally level location inside the Motor Home (such as dinette table) can be used to assist in determining the desired level condition.

### **OFF-ROAD OPERATION**

In order to gain maximum ground clearance both control knobs should be placed in the **"RAISE"** position. It is recommended that a speed of 15 MPH should not be exceeded since the air suspension in this position has maximum pressure supplied.

### **EMERGENCY OPERATION**

In the event of total air loss for any reason the vehicle may be driven at a speed of 5-15 MPH (depending on road surface) with the rear of the vehicle in the fully **"DOWN"** position. Care should be exercised since ground clearance at the rear will be at a minimum.

### **MAINTENANCE**

No routine maintenance is required on the Power Level System. Refer to **SERVICE AND MAINTENANCE** section later in this manual for **"Rear Suspension"** Maintenance.

**For continuing satisfaction keep your Motor Home all GM. General Motors Parts are identified by one of these trademarks:**



The image shows three square logos arranged horizontally. The first logo contains the letters 'GM' in a bold, sans-serif font. The second logo features a stylized 'C' shape with a horizontal bar through it, and the word 'Delco' written below it. The third logo contains the letters 'AC' in a bold, sans-serif font.

# OPERATION OF LIVING AREA FACILITIES

## LIVING AREA FACILITIES CAUTION (CARBON MONOXIDE)

Carbon monoxide is a colorless and odorless gas and can cause unconsciousness and is potentially lethal in high concentrations.

Whenever operating the optional motor-generator it is essential the left-rear window of the vehicle be kept closed to prevent possible entry of motor-generator exhaust gases into vehicle. Inspect the motor-generator exhaust system at vehicle lubrication intervals or when a change is noticed in the sound, alignment, or appearance of the exhaust system or if it is damaged. Do not run motor-generator in a confined area, such as a garage.

The Motor Home is equipped with LP gas operated range/oven, furnace, and may be equipped with an optional gas/electric refrigerator. These components generate carbon monoxide when operated and should be used only if there is adequate ventilation. Whenever operating range or oven(s) be sure power range hood fan above range is turned on, and operating. Also see that all exterior vents on Motor Home for power range hood, furnace and gas/electric refrigerator are open and kept clean and free from clogging materials such as snow, leaves, dirt, grease, etc.

See ENGINE EXHAUST GAS CAUTION (carbon monoxide) page 13.

## LIVING AREA ELECTRICAL SYSTEM

### GENERAL INFORMATION

The Motor Home living area electrical system is designed for utmost convenience. It is capable of supplying the vehicle with power from at least two sources (three, if equipped with a motor generator).

All electrical components except the water heater, the roof mounted air conditioner (if equipped), and the plug receptacles, are powered by the 12-volt auxiliary (living area) battery which is automatically charged each time the vehicle's engine is running.

In addition, your vehicle may be plugged into a 120-volt external power source which will supply 120-volt power throughout the living area, power all 12-volt components through a power converter, and charge the living area battery.

If your Motor Home is equipped with a motor generator, the vehicle will be supplied with 120-volt and 12-volt power throughout the living area, and recharge the living area battery, any time the motor generator is running.

### 120-VOLT & 12-VOLT CONVERTER AND BATTERY CHARGER

The Motor Home is equipped with either a 30 amp or 45 amp 120-volt to 12-volt power converter. Its function is to take a portion of the

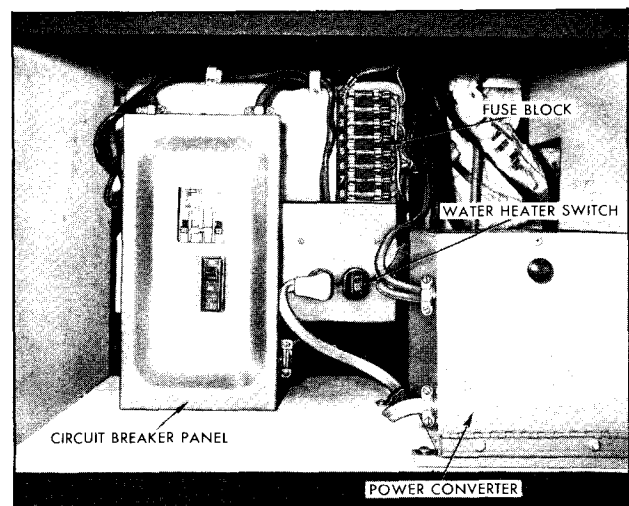

*Living Area Electrical Compartment*

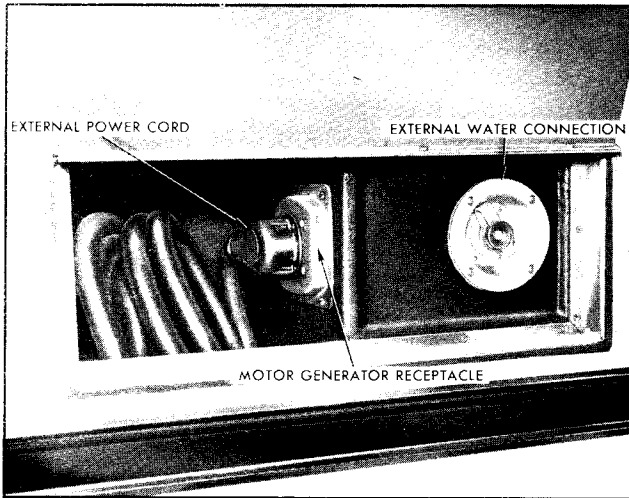

*External Utilities Compartment*

120-volt current, that is received when the vehicle is plugged into an external power source, or when the motor generator is running, and change it to 12-volts which powers much of the Motor Home. It will also charge the auxiliary (living area) battery any time 120-volt current is being received. The unit is located in the living area electrical compartment, next to the hall closet.

All switching operations in the power converter are automatic. It should remain plugged in at all times.

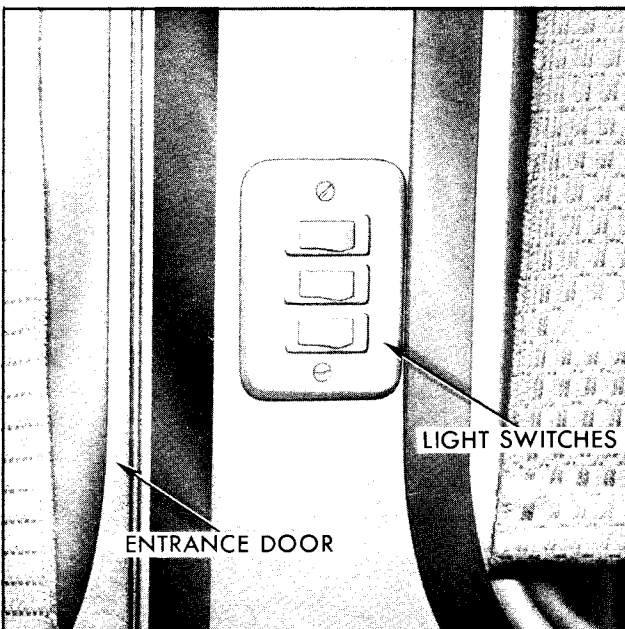

*Light Switch Panel (Typical)*

**IMPORTANT:** Do not pile things on top of or close to the converter. The converter must have a free flow of air through and around the unit. If air flow is restricted, the converter could over-heat which could result in malfunction and permanent damage. Do not let the unit get wet, but do keep it as clean as possible to help assure its long life. The converter can be cleaned with low pressure air (30 PSI maximum) if necessary.

## EXTERNAL POWER

The external utilities compartment located in the left side of the Motor Home contains the 25-foot power cord used for external power connections.

To make an external power connection, remove the cord from the compartment and plug it into a suitable power receptacle. All internal switching will take place automatically. When disconnecting from an external power source the power cord should be plugged into the motor generator receptacle within the external utilities compartment. This connects the motor generator to the Motor Home electrical system. If the vehicle is not equipped with a motor generator simply coil the power cord neatly within the external utilities compartment.

Your Motor Home's external power cord contains two 120-volt circuits, each rated to carry 20 amperes. The electrical connection to be used must be suitable for these requirements. If the receptacle is designed to mate with the prongs on the power cord plug, the electrical connection can be expected to **CARRY RATED LOAD**. It is recommended that the power cord not be plugged in if the receptacle is not designed for your plug. In this event you can use your optional motor generator.

## CAUTION

If the available power supply is other than 120/240 volt, 60 cycle rating, or is not properly grounded, it is essential that no attempt be made to plug in. Your Motor Home's electrical system is not designed for such electrical systems and connection could result in serious personal injury or property damage.

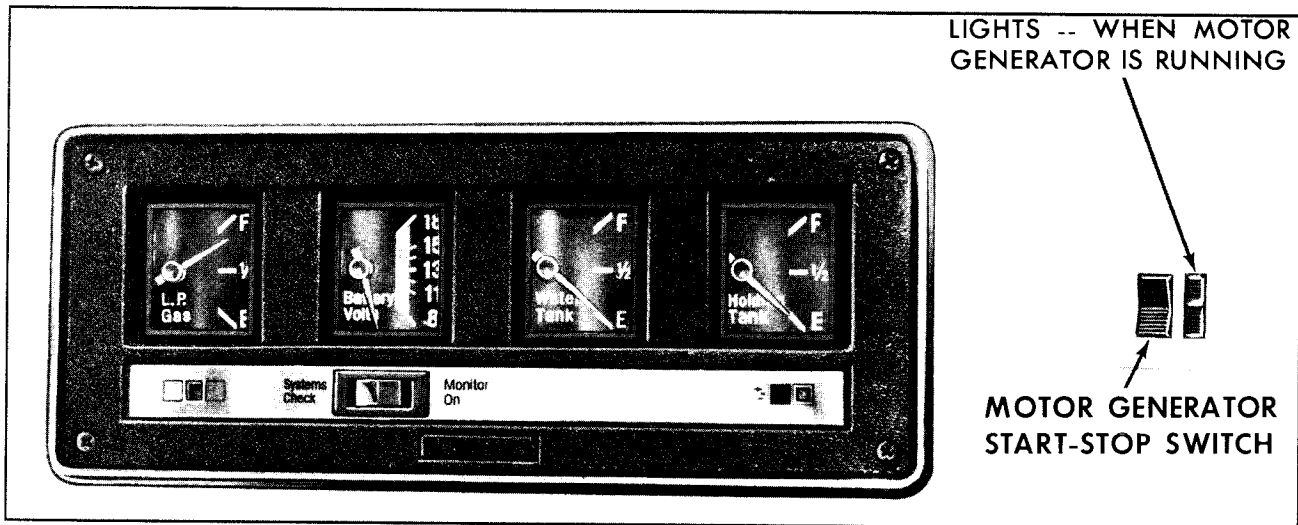

*Monitor Panel and Motor Generator Switch*

## LIGHTING SYSTEM

All the lighting throughout the Motor Home is on the 12-volt system. Some of these lights contain a three-way switch which allows a choice in the amount of light given off. The switches to these lights are located on the light fixture itself.

A panel of light switches is located near the entrance door. These switches operate the porch light, the door courtesy light, and the aisle lights (if vehicle is so equipped).

A step light near the entrance door is designed to automatically come on when the entrance door is opened.

## MONITOR PANEL

The optional Motor Home Monitor Panel is a series of four gauges located at eye level in the living area. Included are:

- **L.P. GAS**—This gauge is designed to indicate the amount of liquid petroleum gas remaining in the tank.
- **BATTERY VOLTS**—During operation, the indicator should remain in the center segment of the dial to indicate normal battery condition. If the indicator shows less than 11-volts, an under-charge condition exists in the living area battery and a recharge is required.
- **WATER TANK**—This gauge is designed to indicate the amount of water remaining in the living area water tank.

- **HOLDING TANK**—This is designed to indicate content level in the holding tank. Never allow this gauge to reach the “FULL” mark. If the holding tank is overfilled the overflow will back up through the bathroom shower drain.

These gauges are activated by a “ROCKER” switch located on the face of the panel. This switch has three positions; “ON,” “OFF,” and “MOMENTARY ON.” An indicator light glows when gauges are operating.

## ONAN MOTOR GENERATOR

**IMPORTANT:** Before operating motor generator see the carbon monoxide caution at the beginning of this section.

The motor generator will allow operation of all 120-volt appliances without an external power connection, thus allowing the vehicle to be independent of an external power source. The motor generator is located in an exterior compartment in the left rear corner of the vehicle.

The unit is mounted on slides and can be pulled out like a drawer for ease in servicing the unit. To slide out the unit depress the buttons on the two latches. Then pull up on safety latch in upper right-hand corner and pull unit out.

## OPERATING INSTRUCTIONS

The unit can be started from inside the Motor Home by using the remote switch which is located above the refrigerator on the Model 230. On the Model 260 the switch is located

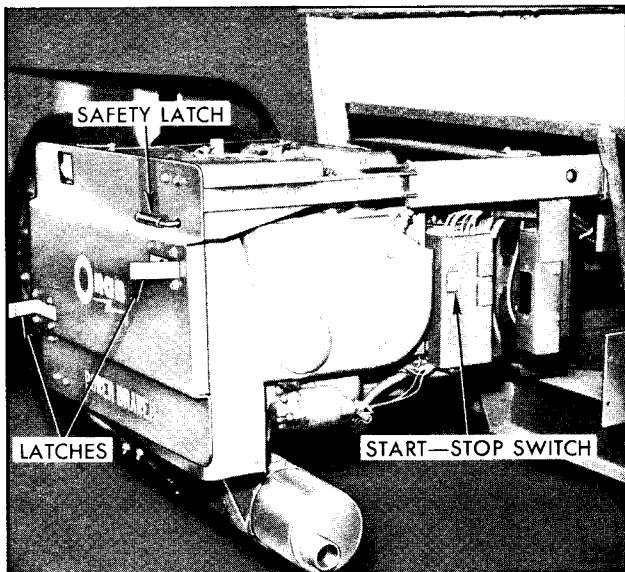

*Onan Motor Generator*

at eye level on the side of the refrigerator. A START-STOP switch is also located on the right side of the generator.

Before starting the motor generator the external power cord must be plugged into the motor generator receptacle. Both of these components are located in the external utilities compartment on the left side of the vehicle. Be sure the crankcase has been filled with oil to the "F" full mark on the dipstick. Check oil only when the motor generator is not operating.

The remote START-STOP switch is a three-position rocker switch. By pressing the top half of the switch the starter on the motor generator will be activated, hold in the switch until the unit is started. The switch should then be released. When the motor generator is running the small red light next to the switch will be lit. To stop the unit depress the bottom half of the switch, and hold in until the unit comes to a full stop. The START-STOP switch on the unit itself operates in a similar manner.

If the motor generator has been running with a full-load connected, disconnect the load and allow it to run for a few minutes (with no-load connected) before pushing STOP button.

The circuit breaker on top of the unit will trip when the demand for electricity in amperes exceeds the motor generators capabilities. If the circuit breaker does trip, remove part of the electrical load and reset the breaker.

## HIGH TEMPERATURE OPERATION

Make sure that nothing obstructs air flow to and from the unit.

Keep cooling fins clean. Motor generator housing should be unaltered and undamaged.

## LOW TEMPERATURE OPERATION

1. Use correct SAE No. Oil for temperature conditions (see SERVICE AND MAINTENANCE section later in this manual to determine proper weight oil). Change oil only when engine is warm.

2. Keep fuel system clean and battery in well charged condition.

## DUSTY AND DIRTY OPERATION

1. Keep unit clean. Keep cooling system clean.

2. Service air cleaner as required.

3. Change crankcase oil and filter more often than normal.

4. Keep governor linkage clean.

## FUEL

The motor generator's fuel is supplied from the vehicle's main fuel tank.

**NOTE:** The motor generator may be operated while the vehicle is underway. However the vehicle's gasoline supply will be depleted at a faster rate.

## KOHLER MOTOR GENERATOR

**IMPORTANT:** Before operating motor generator see the carbon monoxide caution at the beginning of this section.

The motor generator will allow you to be independent of external power connections and prevent excessive battery drain. Your motor generator is located in an exterior compartment on the left rear side of the vehicle.

The motor generator draws its fuel from the Motor Home's gasoline tanks.

## OPERATING INSTRUCTIONS

The unit can be started from inside the Motor Home by using the remote switch which is located above the refrigerator on the Model 230,

and on the Model 260 it is located at eye level on the side of the refrigerator. The switch is a three-position rocker switch. By pressing the top half of the switch the starter on the motor generator will be activated. Hold in the switch until the unit is started. The switch should then be released. When the motor generator is running, the small red light next to the switch will be lit. To stop the unit depress the bottom half of the switch, and hold in until the unit comes to a complete stop.

The external power cord should be plugged into the motor generator receptacle. These items are located in the external utilities compartment. Before starting, the oil level must be checked to make sure it is between the "F" and the "L" marks on the dipstick.

**IMPORTANT:** Check oil only when motor generator is not in operation.

The air inlets should be checked to make sure they are not blocked. The air filter must be properly installed.

There is also a START-STOP switch located on the motor generator itself. It operates in the same manner as the remote switch inside the vehicle.

Directly above the START-STOP switch is a "LOW OIL" light. When the motor generator is two quarts low in oil it is designed to automatically shut itself off, and the "LOW OIL" light will come on. Before it is possible to restart the motor generator oil must be added to the crankcase. There is a reset button above the low oil light which also must be pressed to restart the motor generator.

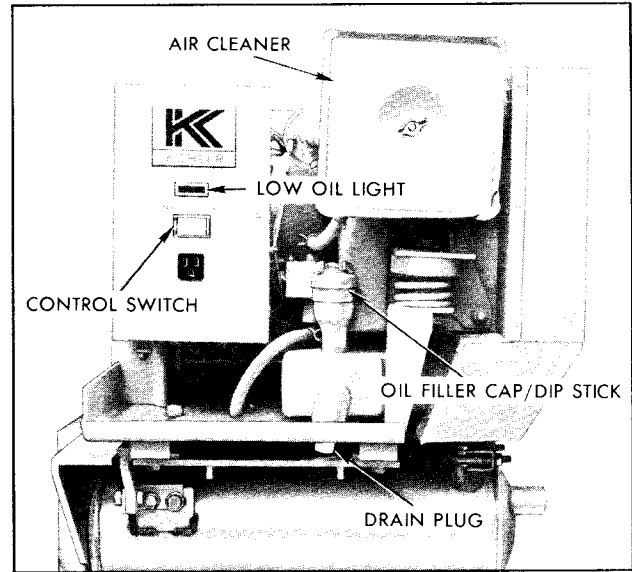

*Kohler Motor Generator*

Directly below the START-STOP switch is a three-prong receptacle. It provides 120-volt 15-amp service.

## FUEL

The motor generator's fuel is supplied from the vehicle's main fuel tank.

**NOTE:** The motor generator may be operated while the vehicle is underway. However the vehicle's gasoline supply will be depleted at a faster rate.

The circuit breaker on the left side of the unit will trip when the demand for electricity in amperes exceeds the motor generators capabilities. If the circuit breaker does trip remove part of the electrical load and reset the breaker.

## LIVING AREA WATER SYSTEM

Your GMC Motor Home is equipped with its own self-contained water system. Refer to "Water System Schematics" on next page. The water tank and pressure pump is located at the right rear corner of the Motor Home. The water pump switch is located on the kitchen wall between the sink and stove.

Water pressure is maintained by a 12-volt water pump which automatically maintains enough pressure to ensure a steady water flow.

A pressure switch is located at the water pump to maintain line pressure between 20 psi and 30 psi.

Information on how to sanitize, drain, and maintain your vehicle's water system can be found in the SERVICE AND MAINTENANCE section.

**IMPORTANT:** Do not attempt to increase water pressure with high pressure air. Be sure the water pump is turned "OFF" when the water

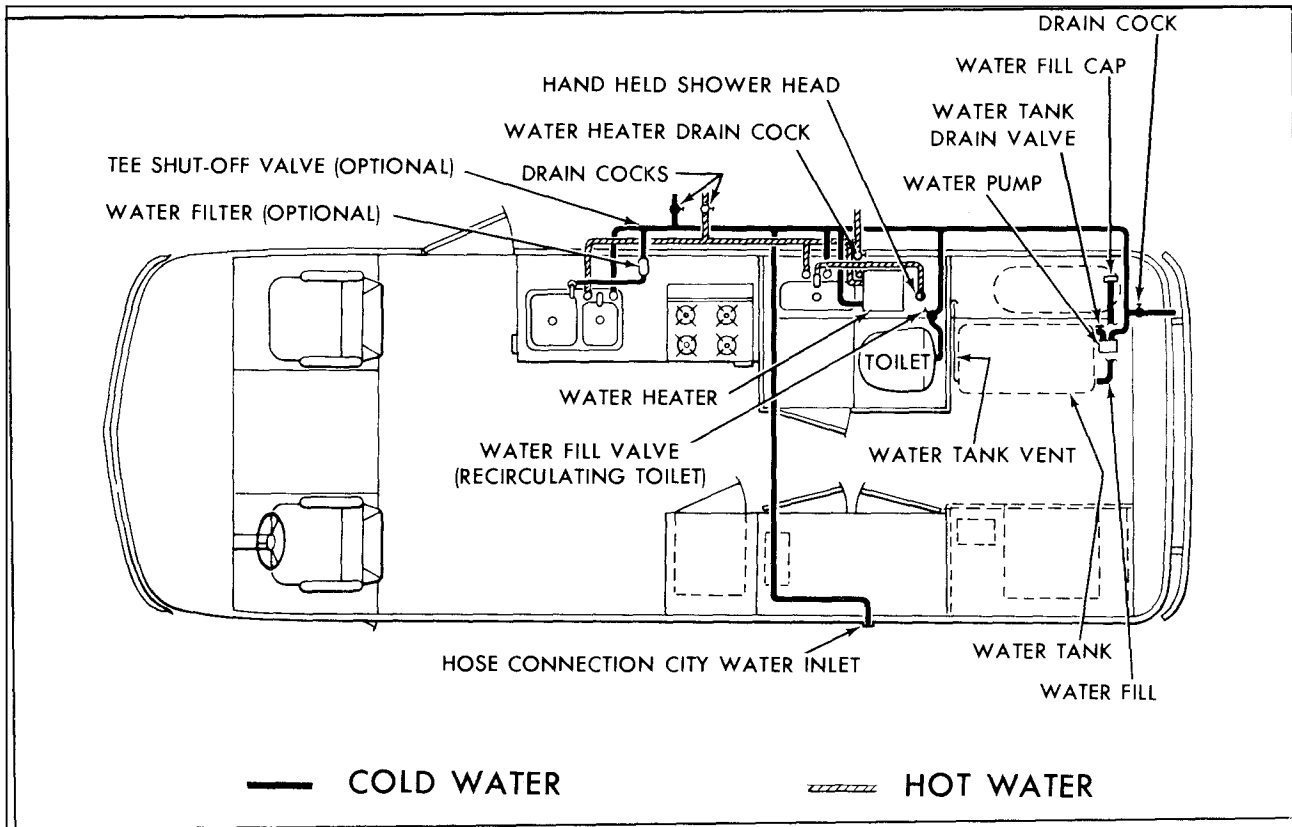

*Living Area Water System Schematic (Model 230)*

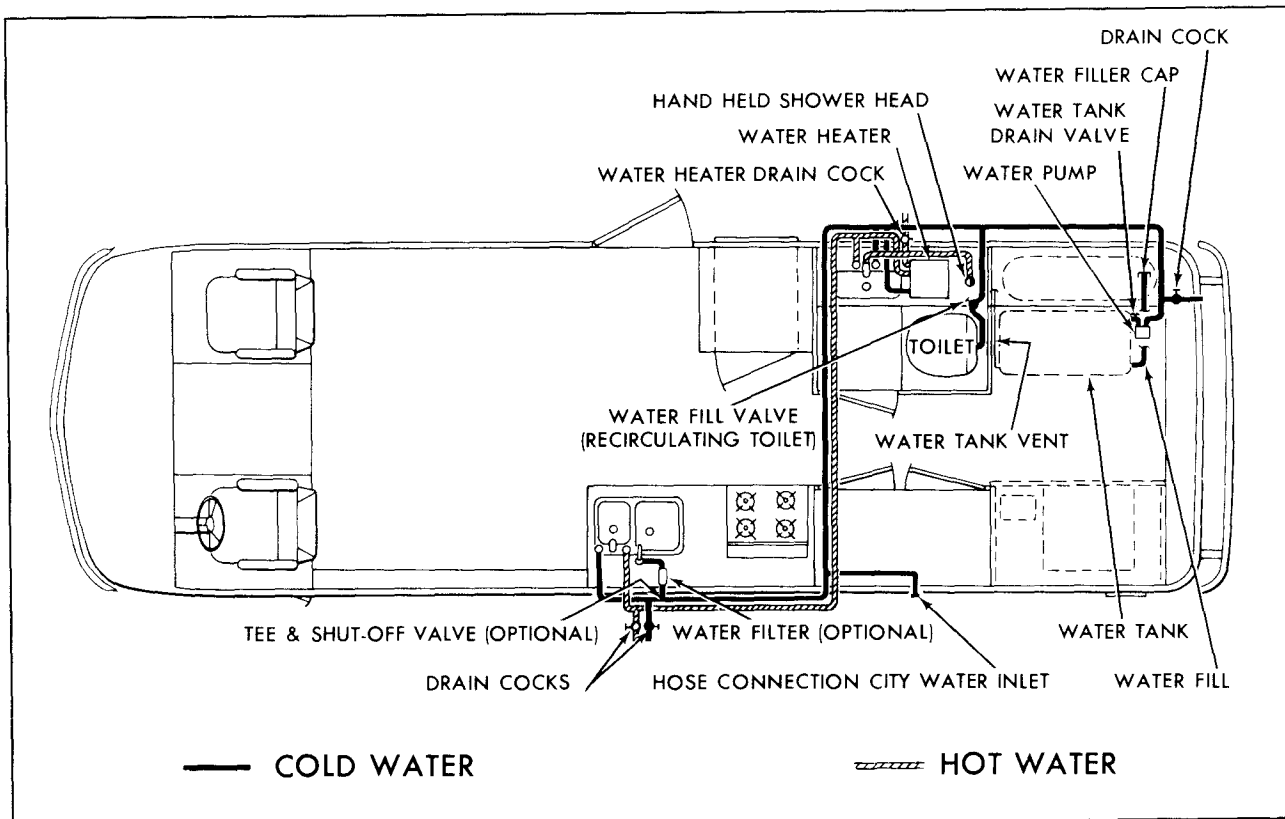

*Living Area Water System Schematic (Model 260)*

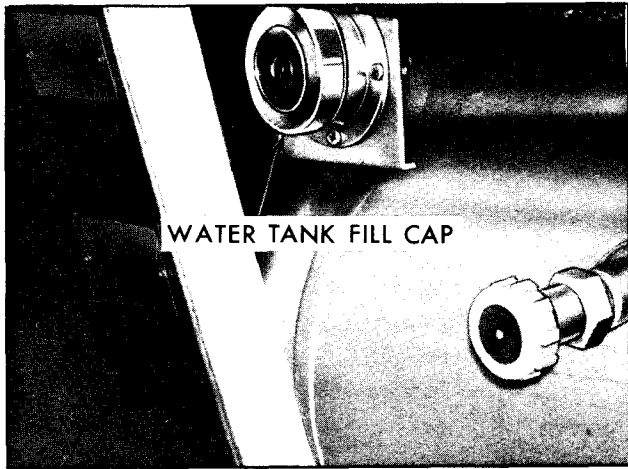

*Water Tank Filler Cap*

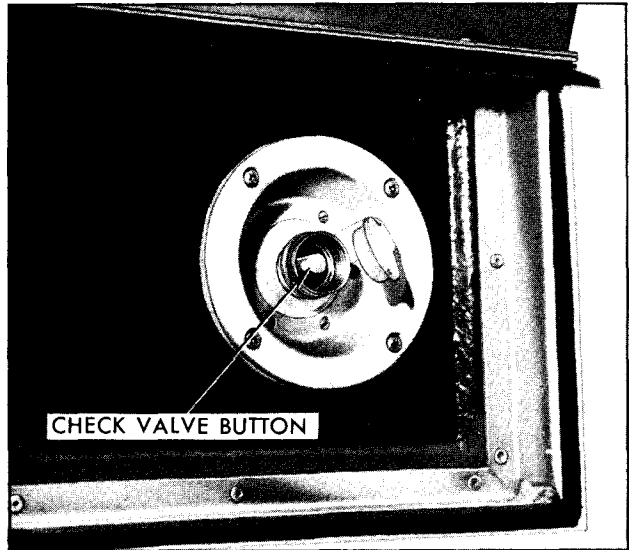

*External Water Connection*

## FILLING WATER TANK

1. Remove outside locking cap located inside the LP gas storage compartment at the right rear corner of the Motor Home.

2. When filling from a pressurized water system (city water or rural area electric pump system) insert garden hose into the top of water fill neck and turn water ON. Capacity of the water tank is 40 gallons.

3. When pressurized water system is not available a pail and funnel may be used.

4. After filling, replace outside filler cap.

**NOTE:** When tank is full, water will spill from the water fill neck.

5. Turn on the pump switch. It may be necessary to open both kitchen faucets to clear air from lines if the water tank has been dry.

## EXTERNAL WATER CONNECTION

Connecting to a park or city water supply is easily accomplished. It is not necessary to drain the vehicle's water system.

1. Remove the plastic cap at the hose connection located in the external utilities compartment.

2. Attach garden hose and turn ON external water supply.

3. When disconnecting hose, be sure to install plastic cap at hose connection to aid in keeping dirt out of water lines.

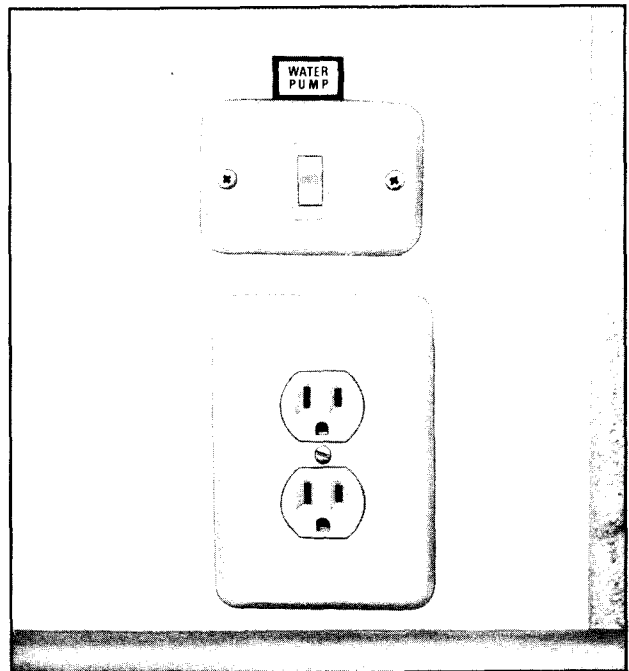

*Water Pump Switch*

## WATER PUMP

A 12-volt pressure water pump is used to operate the water system. The water pump operates off the vehicle's auxiliary 12-volt battery. The water pump is activated by a switch located on the kitchen wall between the sink and stove. The pump's pressure switch is factory adjusted to hold a line pressure from 20 psi to 30 psi. When initially starting the water pump or if



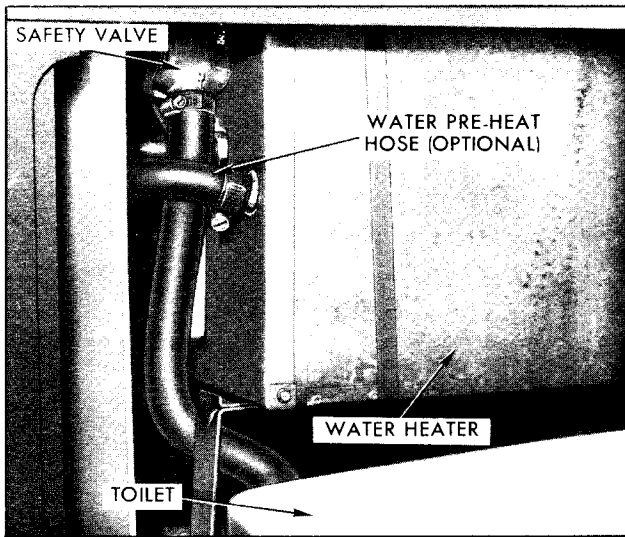

*Water Heater*

the pump has not been operated for some time, open the kitchen faucets to release line pressure before turning ON switch. After pump has been started, leave faucets open until water flows and lines have been cleared of air. Once this procedure has been followed, the pump will work automatically and will maintain a line pressure from 20 psi to 30 psi.

When the water storage tank runs dry, or when the unit will be out of operation for a period of time, the water pump switch should be turned OFF.

It is a good idea to travel with the pump switch OFF unless water is needed. The pump runs quietly and may not be heard.

If the following maintenance problems should arise, follow the step-by-step procedures. If they do not solve the problem, consult a GMC Motor Home service outlet.

1. Pump will not prime (it should do this automatically):
  - a. Check to be sure there is water in the tank.
  - b. Check to be sure battery is not run down.
  - c. Check for kinks in the inlet hose.
  - d. Check for air leaks at inlet fittings. If air is leaking into inlet fittings, tighten fittings or apply clamps as necessary.
  - e. Check for clogged line.
2. Pressure drops:
  - a. Check faucets and connections for leaks.
  - b. Make sure faucet aerators are clean.
  - c. Check to be sure there is water in tank.

- d. Check to be sure the battery is not run down.
3. Pump runs when there is no apparent demand for water:
  - a. Check all faucets and fixtures to make sure they are shut off and not leaking.
  - b. Check lines for leaks.
  - c. Make sure there is water in the tank.

Refer to the "Complete Vehicle Maintenance Schedule" for water pump belt checking interval. Adjustment is required if there is more or less than 1/4 -inch slack in the belt as it is depressed by your finger between the pulleys. To adjust belt tension, loosen the two (2) nuts on the end of the motor, move the motor to provide proper tension and tighten nuts.

## WATER HEATER

Your GMC Motor Home is equipped with a 6-gallon 120-volt AC hot water heater with a factory setting of 150°F. The hot water heater is located behind the lower storage compartment in the bathroom. It is equipped with a drain cock to be used when draining the water system. An "ON-OFF" switch for the water heater is located in the living area electrical compartment. The switch is located in this compartment to prevent the possible hazard of operating the switch with wet hands; i.e., trying to operate the switch after starting to wash or shower.

### CAUTION

**Do not operate water heater unless there is water in the living area water system. If unit is operated without water this will result in damage to the heating element.**

Motor Homes equipped with an optional hot water heater pre-heater will have hot water available if the engine is running and at the normal operating temperature. This is accomplished by circulating engine coolant through hoses to the water heater and back to the engine. Otherwise the hot water heater operates on 120 volt AC power from the motor-generator (if equipped) or from an external 120-volt AC source (see "External Power" previously in this section for additional information).

Motor Home owners without this optional pre-heater may operate the motor generator (if equipped) to obtain the 120-volt AC or wait until reaching your destination to hook-up to an external 120-volt AC source.

# KITCHEN FACILITIES

## ALL-ELECTRIC REFRIGERATOR

The All-Electric Refrigerator will operate on 12-volts DC. This applies to both the six, and the seven and one-half cubic-foot models. It operates on the same principle as the standard domestic refrigerator. If the Motor Home is connected to a 120-volts AC electrical source, 12-volts DC will be supplied to the refrigerator through the power converter.

Turning the thermostat knob to the "OFF" position will stop operation of the refrigerator.

### OPERATION

A single thermostat controls the operation of the refrigerator. This thermostat is mounted at the rear, inside the refrigeration cabinet below the freezer compartment. The knob is marked "OFF, 1, 2, 3, 4, 5." The nearer the knob is set to "5," the colder the temperature becomes in the cabinet.

Once the desired temperature is reached, the thermostat will control the cabinet temperature equally well on either voltage supply.

There is a circuit breaker incorporated in the 12-volt circuit of the refrigerator. It is located behind the kick plate below the refrigerator door. When the circuit breaker opens a small light will come on beside the breaker. The circuit breaker is reset by pushing IN on the red button next to the light.

### OPERATING TIPS

The following operating suggestions will serve as a guide in operating your unit efficiently during 12-volt DC (battery) operation:

1. In order to conserve battery power it is advisable to set the thermostat knob at the lowest setting that will provide adequate refrigeration. This practice will reduce the running time of the refrigerator and draw less current from the battery. A setting of "3" is a normal position.

2. Always operate the refrigerator with a 120-volts AC source connected to the Motor Home when available, especially during initial start-up of the unit. Depending upon the ambient temperature, the initial start-up may require one to two hours continuous operation before refrigeration temperatures are attained and unit cycling begins.

3. Never employ "Quick Chargers" to the battery unless the thermostat is set to "OFF" or the 12-volt DC leads to the refrigerator are disconnected. Damage will occur if the high voltage of the "Quick Charger" is permitted to reach the DC circuitry of the refrigerator.

### Leveling

The All-Electric Refrigerator will operate efficiently 30 degrees off-level so it is not necessary to level the refrigerator.

### Defrosting

Since ice and frost are poor heat conductors, a frost build-up of  $\frac{1}{4}$ " or more should be avoided. It decreases overall cooling capacity and increases power consumption. To lessen frost accumulation avoid putting hot or steaming food in the refrigerator.

To defrost the refrigerator, turn the thermostat to the "OFF" position. When accumulated ice has melted, the water can be removed from the drip pan under the freezer compartment.

### Cleaning

The cabinet interior should be cleaned regularly. Remove shelves and wash the lining with lukewarm water to which a mild soap may be added. Dry thoroughly, especially around door frame and door gasket. Warm water only should be used to wash the cooling evaporator, ice trays and shelves. Never use strong chemicals or abrasive cleaning materials on any part of the cabinet.

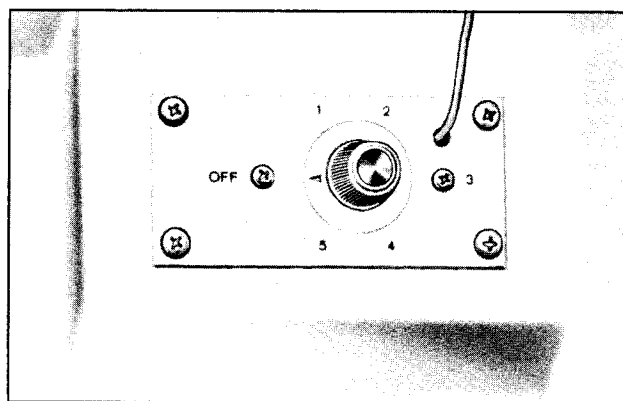

*All Electric Refrigerator (Control Panel)*

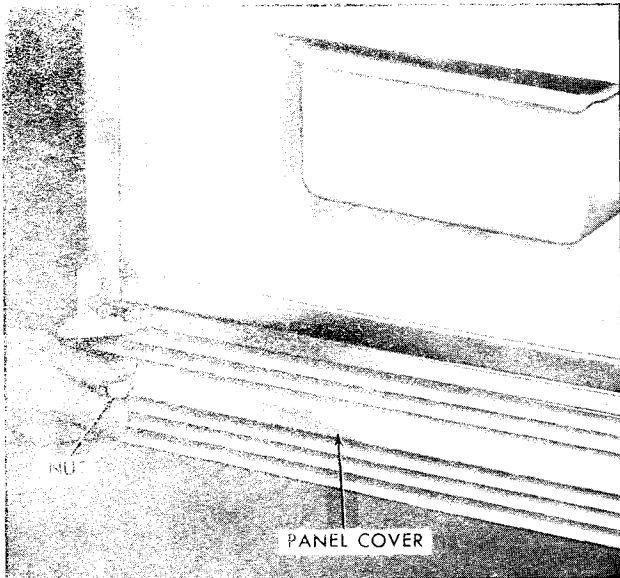

*Removing Gas/Electric Refrigerator Panel Cover*

### To Shut Off Refrigerator

When refrigerator is not in use set the thermostat to "OFF," remove water from drip pan, remove all food-stuffs from cabinet, and leave door slightly ajar to permit air circulation.

## GAS/ELECTRIC REFRIGERATOR

**IMPORTANT:** Before operating the refrigerator in the gas-mode, see the carbon monoxide caution at the beginning of this section.

Your Gas-Electric Refrigerator will operate on L.P. Gas, or 12-volts DC. This results in a wide range of operating modes. The unit is the continuous absorption type, which operates by the application of a small amount of heat. No moving parts are employed. If the Motor Home is connected to a 120-volts AC electrical source, 12-volts DC will be supplied to the refrigerator through the power converter.

### GAS OPERATION

Remove panel cover below door opening.

1. Turn on L.P. gas at the tank.
2. Set electric switch to "OFF" position.
3. Set the gas "ON"/"OFF" knob to "GAS ON" position.

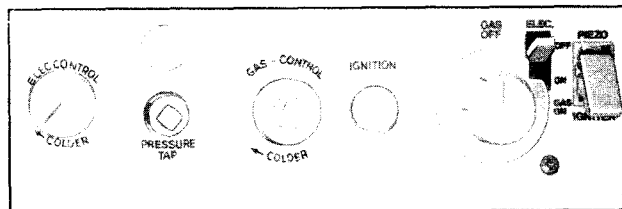

### Gas/Electric Refrigerator Control Panel

5. Turn the "GAS CONTROL" knob to coldest setting.

6. Push in on "IGNITION" button. Depress the "IGNITER" lever and release it after you have heard the audible "click," and the gas burner has been lit.

**NOTE:** In case of ignition failure, depress "IGNITER" lever again as air may be present in the gas lines at the first attempt.

7. Release the "IGNITION" button about 20 seconds after the burner flame has been on.

8. If the cabinet is found too cold, turn the "GAS CONTROL" knob to a warmer setting.

**IMPORTANT:** Always wait five minutes before relighting any gas appliance to allow excess gas to dissipate.

**REMINDER:** The refrigerator should not be operated by gas while the vehicle is underway, the L.P. gas system should be turned off at the L.P. gas tank.

### ELECTRIC OPERATION

1. Take off the panel cover below the door opening.

2. Turn the gas "ON"/"OFF" knob to "GAS OFF" position and slide the electric "ON"/"OFF" switch down to the "ON" position.

3. Turn the electric temperature control knob to the coldest setting.

4. In case the cabinet is too cold, turn the electric temperature control knob to a warmer setting.

**NOTE:** It is recommended that the refrigerator be started on external power or on gas operation, to avoid excessive battery drain.

## CHANGE FROM ELECTRICITY TO GAS

1. Be sure to set the electric "ON"/"OFF" switch to "ELECTRICITY OFF" position, then follow the instructions for "Gas Operation."

2. When burner is lit, turn gas temperature control to desired setting.

## CHANGE FROM GAS TO ELECTRICITY

1. Follow the instructions of the "Electric Operation" of refrigerator.

2. Turn the electric temperature control knob to desired setting.

## OPERATING TIPS

The Gas/Electric Refrigerator is equipped with an automatic flame failure device. The purpose of incorporating a flame failure device in the burner assembly is to help prevent unburned gas from escaping from the burner and to help avoid a fire hazard. A thermocouple in this device is designed to sense the drop in heat when the flame goes out and automatically shut off the gas supply. When the refrigerator will not be in use, take the precaution of rotating the gas knob to the "GAS OFF" position, to help reduce the possibility of leaking gas.

To prevent the refrigerator door from opening while in transit, it is equipped with a pin lock. It is located on top of the door and should be installed before moving vehicle.

## Leveling

To ensure proper operation of the unit it must be level. To check, a level should be used. The level should be placed on the ice tray compartment shelf. When this shelf is level, the entire unit will be level.

When traveling the continuous rolling and pitching movement will not affect the refrigerator as long as the movement passes either side of level, but when the Motor Home is parked the sensitivity of the refrigerator should be kept in mind.

## Temperature Control (Thermostat)

The temperature control (thermostat) will permit variation of cabinet temperature. The position of the temperature control should depend upon the refrigerator load. When the food load is heavy, turn the temperature control to a higher step. A higher setting of the temperature control will be required in summer than in winter season.

## To Shut Off Refrigerator

If for any reason refrigeration is not required for some period, the gas and electric switches should be turned off.

Foodstuffs should be removed from the cabinet, ice trays should be emptied, and the entire interior of the refrigerator should be cleaned and dried. It is advisable to block the door open when not in use.

## Defrosting

Since ice and frost are poor heat conductors, a frost build-up of 1/4-inch or more should be avoided. It decreases over all cooling capacity and increases power consumption. To lessen frost accumulation, avoid putting hot or steaming food in the refrigerator.

To defrost the refrigerator, turn the thermostat to the lowest position. When accumulated ice has melted, the water can be removed from the drip pan under the freezer compartment.

## Cleaning

The cabinet interior should be cleaned regularly. Remove the shelves and wash the lining with lukewarm water to which a small amount of soap may be added. Dry thoroughly, especially around door frames and door gasket. Warm water only should be used to wash the cooling evaporator, ice-trays and shelves.

Plastic storage compartment may be washed in warm soapy water—not hotter than is bearable to the hands. Do not expose them to dry heat. Never use strong chemicals or abrasive cleaning materials on any part of the cabinet.

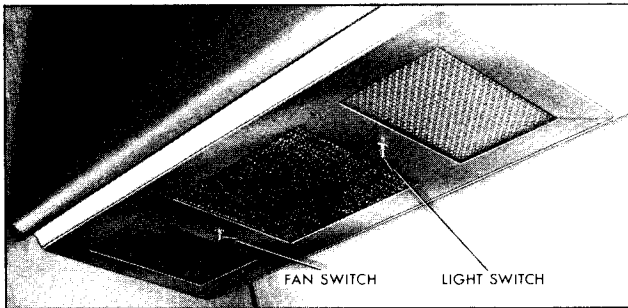

*Power Range Hood*

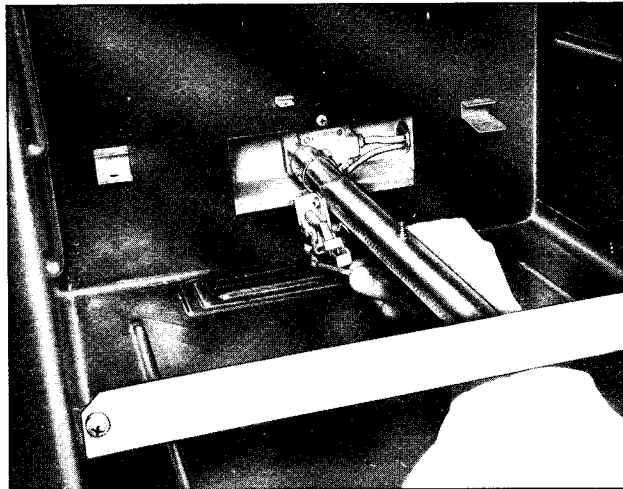

*Lighting Oven Pilot*

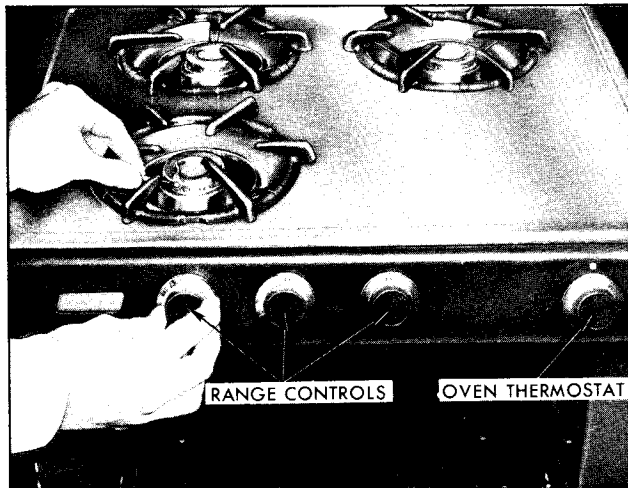

*Lighting 3-Burner Range*

## KITCHEN RANGE/OVEN

**IMPORTANT:** Before operating the Range/Oven see the carbon monoxide caution at the beginning of this section.

**Always wait 5 minutes before relighting Range/Oven to allow excess gas to dissipate.**

Recreational vehicle range/ovens differ from conventional residential units in several ways:

1. The units are more compact.
2. The units are equipped with thermostat controls which allow you to manually shut off the gas to the pilots when traveling.
3. Clips are provided for the top burner grates and oven rack to help prevent rattles and dislodgement while traveling.

Any time the range/oven is in operation, the power range hood fan should be operating to help ensure proper ventilation.

In order to operate the range/oven the gas supply must be turned on at the L.P. gas tank.

### CAUTION

The Range/Oven should not be used when the vehicle is moving. The burners or pilot lights may blow out creating a fire or explosion hazard. In addition, a sudden movement of the vehicle could throw utensils or scalding liquids from the stove which could result in serious personal injury or property damage.

## OPERATION OF 3-BURNER UNIT

### Range

1. Turn on power range hood fan.
2. Be sure all knobs are in the intended position.
3. Light a match and hold close to the edge of burner you wish to use.
4. Push appropriate control knob in and turn gas on all the way to get gas to the burner.
5. After lighting, flame may be reduced to the desired height.
6. To turn off the flame, turn the knob all the way to the "OFF" position. The knob is designed to lock in this position. Always check that range burners are fully off after use, to help avoid hazards from leaking gas.

### Oven

1. Turn on the power range hood fan.
2. Be sure all knobs are in the "OFF" position. The oven thermostat should be in the "PILOT OFF" position.
3. Depress the oven thermostat and turn to "OVEN OFF" position.

4. Open the oven door, allow compartment to ventilate, then light the oven pilot with a match. A small flame should be noted at the top of the pilot burner. After the initial light-up, it may take a minute or so to clear the air from the line so the flame stays lit.

5. To light the oven burner, depress and turn the thermostat dial counterclockwise to the desired temperature setting. It will take approximately 45 seconds before the safety valve will open and the oven burner ignites.

6. When use of the oven is finished, turn the thermostat dial to the "OVEN OFF" position. In this position the oven pilot is designed to remain lit.

7. When traveling or when the Motor Home is not in use, return the thermostat dial to the "PILOT OFF" position. This should turn off the gas to the pilot. The oven pilot is non-adjustable.

### OPERATION OF 4-BURNER UNIT

The 4-burner range/oven has two pilots—one for the four range burners and one for the oven. These pilots are both controlled at the oven thermostat.

#### Pilots

1. Turn on power range hood fan.
2. Be sure all knobs are in the "OFF" position. The oven thermostat should be in the "TOP & OVEN PILOTS OFF" position.
3. Depress the oven thermostat and turn to "OVEN OFF" position.
4. Lift cook top panel and light range pilot with a match as shown.
5. Open the oven door, allow compartment to ventilate, then light the oven pilot with a match (see illustration under "Operation of 3-Burner Unit"). A small flame should be noted at the top of the pilot burner. Upon initial light-up, it may take a minute or so to clear the air from the line so the flame stays lit.

#### CAUTION

**When lighting pilots, BOTH pilots must be lit, even if plans are to use just one cooking means. Once the oven thermostat is moved from the "TOP & OVEN PILOTS OFF" position, gas will issue from both the range and oven pilots. Failure to light both pilots could result in fire or explosion caused by accumulating L.P. gas.**

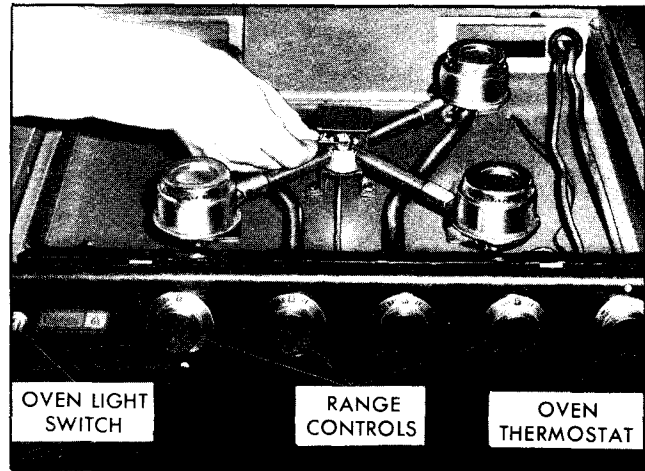

*Lighting 4-Burner Range Pilot*

6. The oven pilot is non-adjustable. The top pilot (range) should burn with a blue flame having a slight yellow tip. The tip of the flame should extend to approximately the top of the lighter body. The adjustment screw is located behind the oven thermostat dial.

#### Range

1. Be sure power range hood fan is operating.
2. Push control knob in and turn gas on all the way to get gas to the burner.
3. As soon as burner lights, flame may be reduced to the desired height.
4. To turn off the burner, turn the control knob all the way to the "OFF" position. The knob is designed to lock in this position.

#### Oven

1. Be sure power range hood fan is operating.
2. To turn on the oven light, push in oven light button located at the left side of the knob panel. Push again to turn out.
3. To light the oven burner, depress and turn the thermostat dial counterclockwise to the desired temperature setting. It will take approximately 45 seconds before the safety valve will open and the oven burner ignites.
4. When through with oven, turn the thermostat dial to the "OVEN OFF" position. In this position the oven pilot will remain lit.

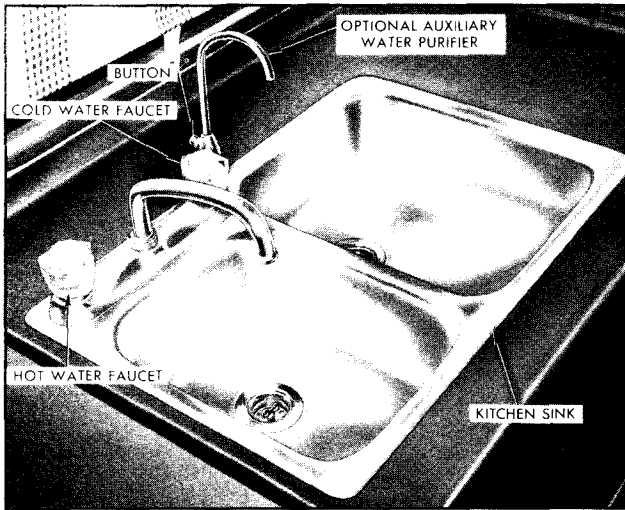

*Kitchen Sink*

5. When traveling or when the Motor Home is not in operation, return the thermostat dial to the "TOP & OVEN PILOT OFF" position. This should turn off the gas to the pilots.

#### CARE AND CLEANING

- **POWER RANGE HOOD FILTER**—It is important that the power range hood filter be inspected frequently and cleaned as needed. To clean filter, remove retaining nuts at power hood switches, remove filter and wash in hot, soapy water. Rinse thoroughly and reinstall.
- **GENERAL**—Regular cleaning with a warm detergent solution and a soft cloth will keep your range looking bright and new. This should be done as soon as range cools.
- **CHROME**—To keep the mirror bright finish, wipe with a damp cloth and dry thoroughly. Stubborn stains may be removed with lemon juice, vinegar, or chrome polish.

**NOTE:** Properly clip the top burner grates and oven rack after cleaning to help prevent them from rattling or becoming dislodged while the vehicle is underway.

- **GLASS**—Wipe cooled glass with detergent and hot water. Rinse and polish with a soft cloth.

- **BROILER PAN**—Remove the broiler pan from oven immediately after use. Drain fat. Sprinkle rack with detergent and cover with wet paper towels and let soak before washing in hot soapy water.
- **OVEN DRUM**—Clean as soon as possible after use when the oven is cool. Grease splatters that are allowed to become hard and baked on become very difficult to remove. Care must be taken to avoid bending the tube clipped to the top of the oven. This is the thermal sensing element and could cause a variation between the oven temperature and the dial setting. If oven cleaners are used, be sure to rinse the tube thoroughly and wipe dry.
- **TOP BURNERS**—Top burners may be cleaned with a detergent solution. If any burner port should become clogged, clean with a toothpick. Never use pins or other metal objects to clean the ports, as they may become enlarged. If the burner is washed in a sink, dry immediately by shaking off all excess water and lighting the burner until all water has evaporated.

#### OPERATING TIPS

- The Range/Oven is not designed for and should never be used as a space heater. Do not leave the oven door open while the oven is on.
- Do not operate range/oven while traveling or while refueling your vehicle at a gasoline service station. The pilot lights or burners may ignite gasoline fumes.
- Do not leave the top burners on without a utensil for any length of time. Overheating of the grates may cause the porcelain enamel to craze and chip.
- If your range has an oven light bulb, do not clean it while hot. After it has cooled, wipe it clean with a damp cloth.

## KITCHEN SINK AND AUXILIARY WATER PURIFIER

Your GMC Motor Home is equipped with a stainless steel double bowl sink with a swing spout. For cleaning and care of the stainless steel sink see the **APPEARANCE CARE** section later in this manual for more information.

An optional auxiliary water purifier is located near the kitchen sink. The purifier filter cartridge is mounted next to the range/oven and on the underside of the countertop. The filter cartridge requires no maintenance or adjustment either before installation or during operation. The filter cartridge has a limited life dependent upon the quality of the domestic water supply and its level of use. Replacement of the filter cartridge can be accomplished without the use of tools. To remove the cartridge remove the top drawer next to the sink and move the wire loop to a horizontal position. Grasp the

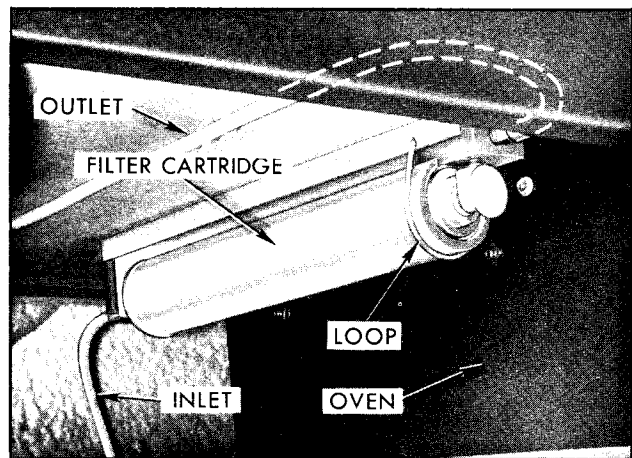

*Auxiliary Water Purifier Cartridge*

cartridge and pull down approximately one inch and then pull out and towards you. Refer to your GMC Motor Home service outlet for replacement filter cartridges.

## BATHROOM FACILITIES

### CAUTION

If your vehicle is equipped with a **Thermasan Waste Destruction** system, it is especially important that flammable cleaning agents, solvents or other highly combustible materials never be allowed to enter the holding tank via the kitchen or bathroom sinks, toilet or shower drains. These materials could create an explosion hazard in the vehicle exhaust system. For further information refer to the **CAUTION** and text under the "THERMASAN SYSTEM" in this section.

### STANDARD TOILET

The standard toilet is a fresh water sanitation system. It uses a pressure flushing system wherein water cleans the bowl with each flush and washes contents directly into the holding tank. This water injection produces a swirl effect and uses a measured amount of water to rinse efficiently. The unit is a self-cleaning type designed with an odor and gas tight teflon seal which closes off the holding tank when not in use. Since every flush uses fresh water, chemical additives are not mandatory.

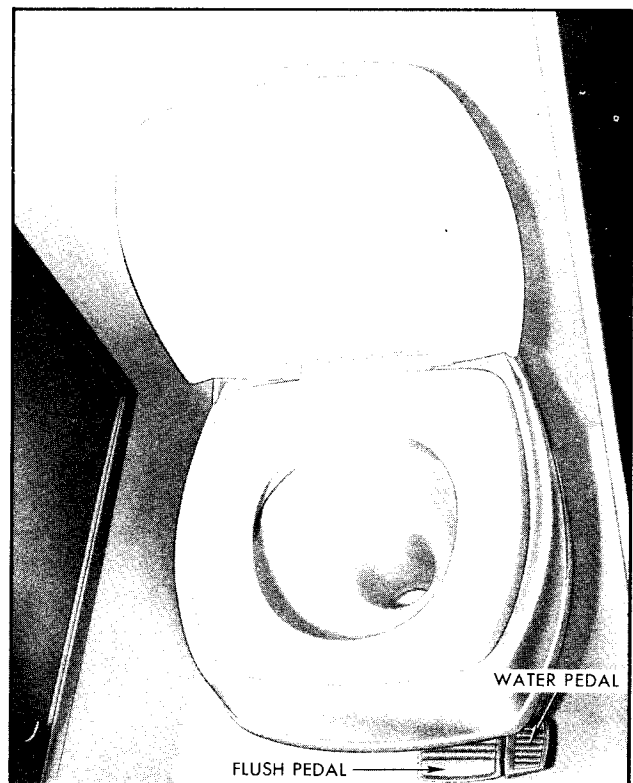

*Standard Toilet*



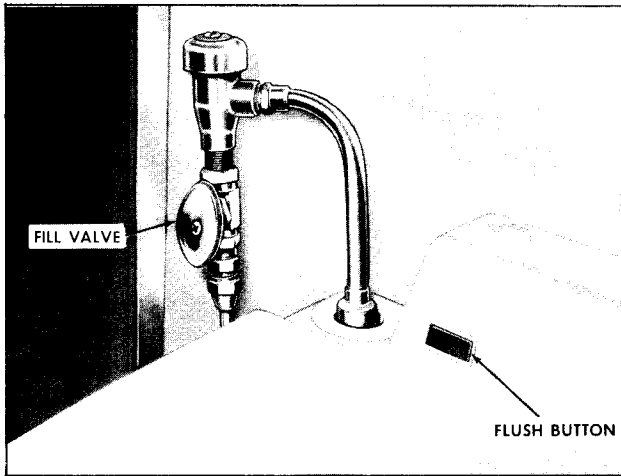

*Recirculating Toilet Controls*

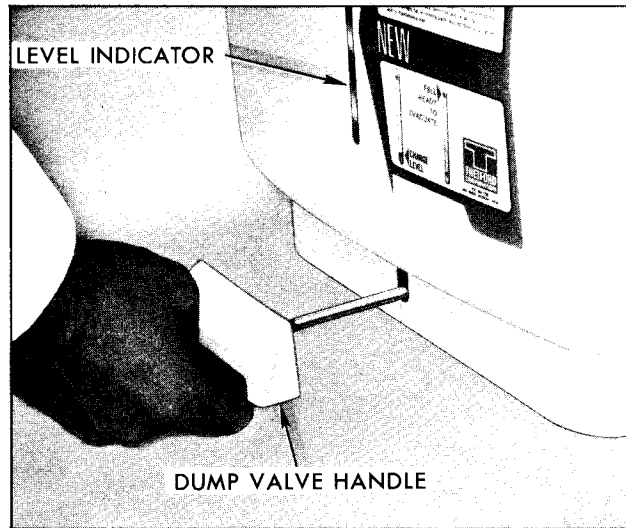

*Dumping Waste Contents of Recirculating Toilet*

## OPERATING INSTRUCTIONS

1. After use, depress flush pedal located at base of toilet. This will automatically flush and refill toilet with water. Keep pedal depressed until bowl is cleansed and release.

2. If you wish to add water to bowl without flushing, depress the water pedal. Hold depressed until desired water level is reached and release.

3. Cleaning of toilet bowl can be accomplished by using any high grade, non-abrasive cleaner. Highly concentrated or high acid content cleansers might damage rubber seals.

4. The standard toilet dumps directly into the vehicle holding tank. Therefore it is recommended that holding tank be drained at regular intervals to avoid overflowing. If vehicle is not equipped with a ThermoSan System, a suggested drain interval would be whenever refilling living area water tank.

## OPERATING TIPS FOR EITHER TOILET

1. Do not put facial tissue, automotive type anti-freeze, coffee grounds, laundry bleach, or highly concentrated or high acid content household cleaners in your holding tank or toilet systems as they may damage the plastic or rubber parts in the system.

2. Special non-toxic non-flammable deodorizing chemicals can be added to holding tank, but are not required. Follow directions on container.

3. Most toilet tissues are usable in system.

Several special tissues designed to break down and flow away readily are available.

4. Keep your holding tank drain valve closed when parked and connected to a sewer system. By doing this, enough fluids are put into the holding tank to entirely wash away the waste in the holding tank when drain valve is opened.

5. Details on winterizing or draining vehicle holding tank are covered in the **SERVICE AND MAINTENANCE** section of this manual.

## RECIRCULATING TOILET

The optional recirculating toilet operates by recirculating a chemical solution. The advantage is that you are conserving water when flushing and also by not adding volume to your holding tank. The toilet operates on 12-volt DC.

## OPERATING PROCEDURES

### Initial Flush Charge

1. Be sure handle on dump valve is pushed in.
2. Open fill valve, filling toilet to the charge level as indicated by the letter "C" on prism. This will be approximately 3 gallons. Close the fill valve.
3. Add recirculating toilet chemical as recommended by manufacturer of chemical.

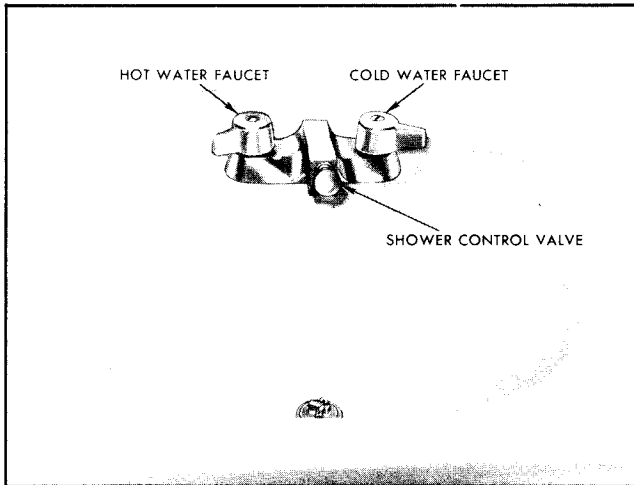

*Bathroom Sink*

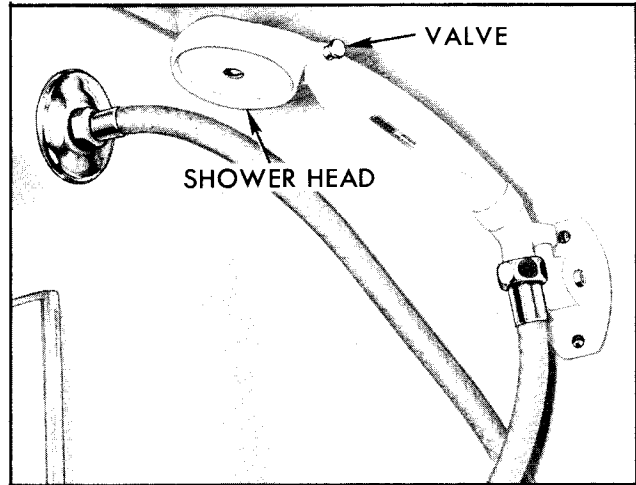

*Shower Head*

### To Flush

Depress flush button. Timer will provide a seven second flush cycle.

### To Empty Toilet Into Holding Tank

1. When prism indicator shows level at the letter "F" it is time to empty the toilet. When full, toilet holds approximately seven gallons. The toilet may also be emptied when the blue chemical solution turns green as this is an indicator that the active ingredients are used up.

2. Pull the dump handle all the way out. The handle is located near the floor at the center of the front of the toilet. When toilet is empty, as indicated by the prism, push the handle back in and recharge toilet as directed under "Initial Flush Charge" described previously.

### CLEANING TIPS

1. There are several excellent cleaning compounds that may be used. Be sure to read the label to be sure compounds will not damage plastic parts and tubing.

2. Recreational users advise it is best to flush the toilet before each use to aid in maintaining cleanliness.

3. Another aid to flushing is to lay some toilet tissue in the bowl just prior to use.

## BATHROOM SINK AND SHOWER CONTROL VALVE

Your Motor Home is equipped with a bathroom sink with an integral shower control valve in the spout.

With the shower control valve knob pushed in, the off position, water temperature may be adjusted prior to taking a shower. Once the desired temperature is set, remove the shower head from the wall and point towards the sink. Open the valve at the shower head, pull the shower control valve knob out and allow water to flow into sink until it warms to the desired temperature. Adjustments in temperature may be made as required.

Showers can take a lot or a little water. A suggestion would be to take a "camper's" shower. Wet yourself down, then turn off the water at the shower head, soap up and then turn water back on to rinse.

### SHOWER HEAD

The shower head and flexible hose mounts to a bracket on the bathroom wall. The valve in the shower head is shown in the on position. Pushing the shower head valve to the left will shut off the water.

**NOTE:** Leave shower head valve in off position when not in use to avoid getting showered unexpectedly when the shower control valve is turned on.

## THERMASAN SYSTEM

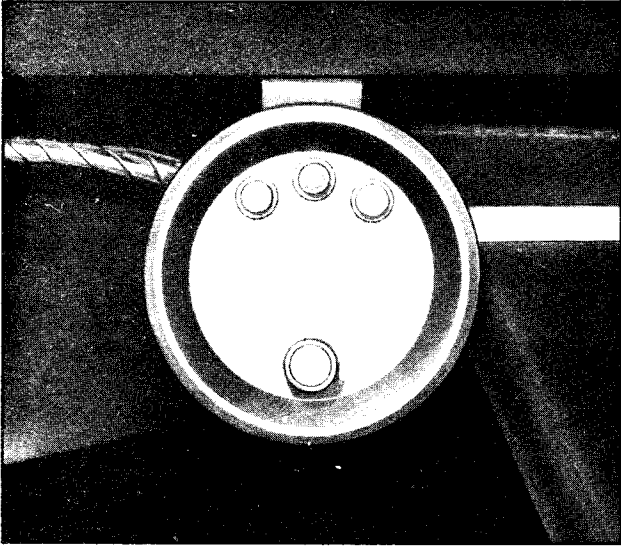

*Thermasan Controls*

The optional Thermasan System on Motor Homes is a waste destruction system that virtually eliminates the inconvenience of holding tank evacuation stops.

The Thermasan System follows a relatively simple procedure. A chemical and biochemical action is first created in the contents of the holding tank. This waste is next pumped into a sanijector which screens and sprays it into the engine's exhaust system. The waste is destroyed to the extent that all remaining gaseous by-products are rendered invisible, bacteria free, harmless, and meet emission requirements of Public Health and Federal Emission Standards.

### OPERATION

To operate your Thermasan System, two factors must be present. An exhaust temperature of at least 900-1000°F., and the vehicle's speed must exceed 35 mph. Operation of the control panel, without these factors being available, will not start the system. If the exhaust temperature should drop below limits, or the vehicle speed is reduced, operation of the system will be temporarily interrupted.

The Thermasan controls are located to the right of the steering column in the driver's compartment. The panel face contains an "ON"/"OFF" switch, a push to test button, and three indicator lights. The "ON"/"OFF" switch contains a rheostat control to be used if dimming the indicator lights is desired during night operation.

When switched to the "ON" position, the green "READY" indicator will light. This tells you the system is operational. When the speed and temperature requirements are met, the red "REACTION" indicator will light, which tells you the system is physically destroying waste if waste is present. When the white indicator lights, the system has destroyed all waste available and it should be turned "OFF." When the "ON"/"OFF" switch is pulled-out, the "READY" and "REACTION" indicator lights will flash if the pump is injecting waste.

The system operates on 12-volts and will destroy up to five gallons of waste per hour, depending on the condition of the waste, the speed of the vehicle, etc.

### CAUTION

**Do not put any highly combustible materials such as kerosene, alcohol, or gasoline in your holding tank since it could create an explosion hazard in the vehicle exhaust.**

Do not winterize your Motor Home with fuel oil or kerosene, which might get into the holding tank. We also recommend that facial type tissue be kept from the holding tank because they have "wet strength" and they will not properly dissolve for passage through the waste pump.

Occasional draining of your holding tank at an approved dumping station is recommended. This should be done at least annually to remove any foreign particles or other insoluble matter.

# VENTILATION

## WINDOWS

The side windows in the driver's compartment are operated by squeezing the latch and sliding the window to the rear.

The side windows in the living area are equipped with screens. The windows are operated by sliding the screen out of the way to gain access to the window latch. Then squeezing the latch and sliding the window to the open or closed position as desired.

## CEILING VENTS

The purpose of the ceiling vents is to allow warm air to escape that may accumulate at ceiling level when the vehicle is parked in the sun. The opening of a ceiling vent and a window

will aid in removing condensation from the windows.

The vents are crank-operated from inside the Motor Home. In rainy weather it is possible to leave the ceiling vents open slightly for ventilation without entry of water into the Motor Home (depending upon the magnitude and direction of rain).

**NOTE:** All windows and roof vents must be tightly closed when operating the air conditioner or furnace to obtain maximum cooling or heating.

Power fans are available for the ceiling vents. These will increase the efficiency of the vent. They are operated by the button switch at the corner of the vent.

## ROOF MOUNTED AIR CONDITIONER

The controls for the unit are located in the ceiling of your Motor Home, this unit can provide either cooling or air circulation.

The unit is operated by setting the thermostat knob to the desired temperature setting. The blower switch is then set at the desired position. The "HI-FAN" setting provides high speed fan operation only; the "LO-FAN" setting provides low speed fan operation only. The "HI-COOL" position cools with high speed fan operation. The "LO-COOL" position cools with low speed fan operation. If your unit is equipped with a heater it can be activated by moving the blower control to the "HEAT" position.

Air distribution either from the front or rear of the unit, is controlled by the sliding knob. With the knob positioned toward the front of the unit, the air flow will be from the front vent. The knob can be positioned toward the rear to activate the rear vent. An intermediate position will provide a proportional mixture of air to the front and rear vents.

The unit is shut down by placing the blower switch in the "OFF" position. This unit is equipped with a delayed start feature. When the unit is turned on, fans will start, and in approximately 60 to 90 seconds, compressor will start.

When turned off, unit will not restart for approximately two minutes.

The air filter must be checked and cleaned frequently as required by use. To remove filter grille, pull forward edge of grille downward to disengage grille from its retaining slots. Wash filter in warm soapy water, rinse, shake off excess water and allow to dry normally. (Do not use compressed air to dry filter.)

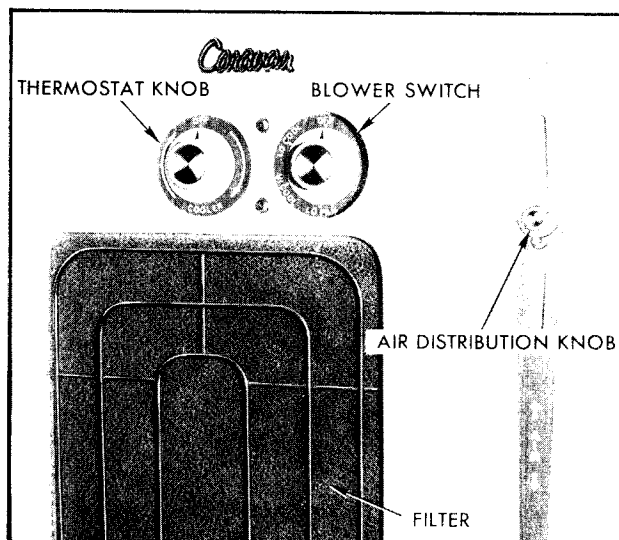

*Roof Mounted  
Air Conditioner Controls*

# FURNACE

**IMPORTANT:** Before operating the furnace see carbon monoxide caution at the beginning of this section.

The furnace is located in the compartment under the kitchen sink. Two sizes are available with either 22,000 BTU or 30,000 BTU capacities.

The furnace is operated on 12-volt DC only.

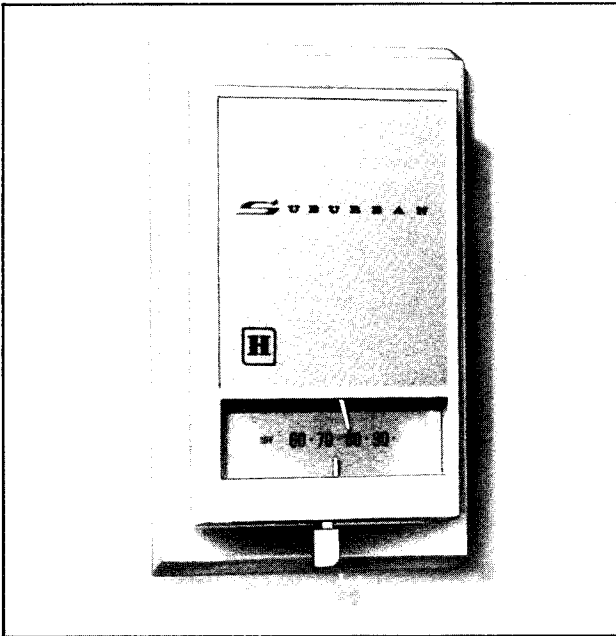

*Furnace Thermostat*

## SEQUENCE OF OPERATION

Whenever operating the furnace the window above it should be fully closed, to help avoid drawing carbon monoxide exhausted from its vent back through the window.

When the thermostat is adjusted to the desired setting, furnace blower motor is energized immediately. After three to five seconds the main burner of furnace will ignite. Following two minutes of burner operation a "snap" will be heard from within the furnace. This is the furnace fan switch changing to its normal run position. After this occurs, and the thermostat is satisfied or is turned to a lower setting the main burner flame will go out, but the blower will continue to run for a short period of time and then shut off.

If thermostat is adjusted to a lower setting, or to "OFF" before the furnace has operated for two minutes the blower and main burner will shut off at the same time.

**REMINDER:** The furnace should not be used when the vehicle is underway, and the LP gas should be turned off at the LP gas tank.

## LIGHTING FURNACE

**NOTE:** Be sure manual control valve at LP gas tank is fully open.

1. Set thermostat, located in rear of Motor Home living area to "OFF" position.
2. Open furnace manual valve fully, located under sink near the sink trap. Do not attempt to

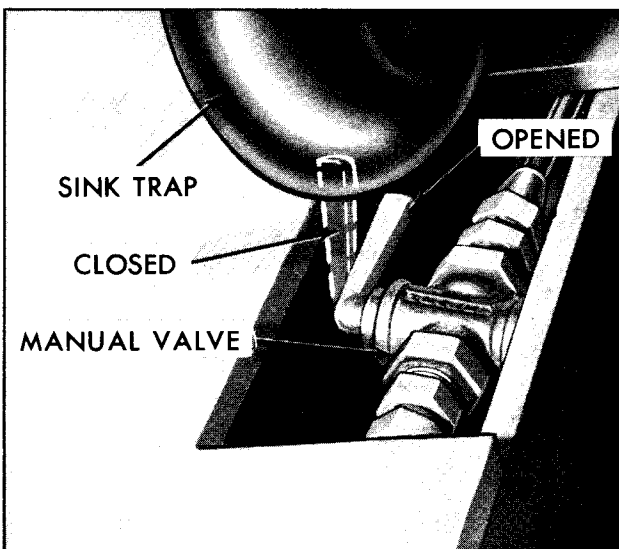

*Furnace Manual Valve*

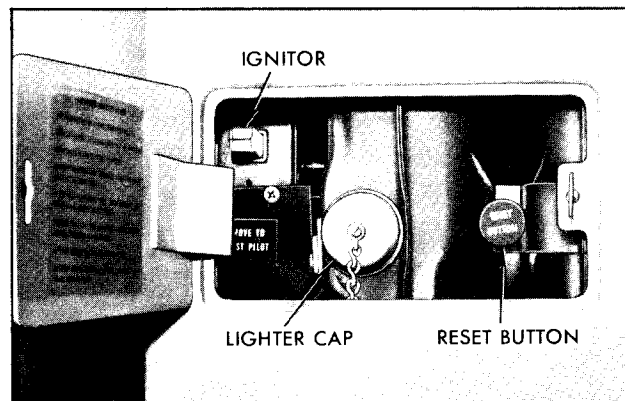

*Furnace Controls*

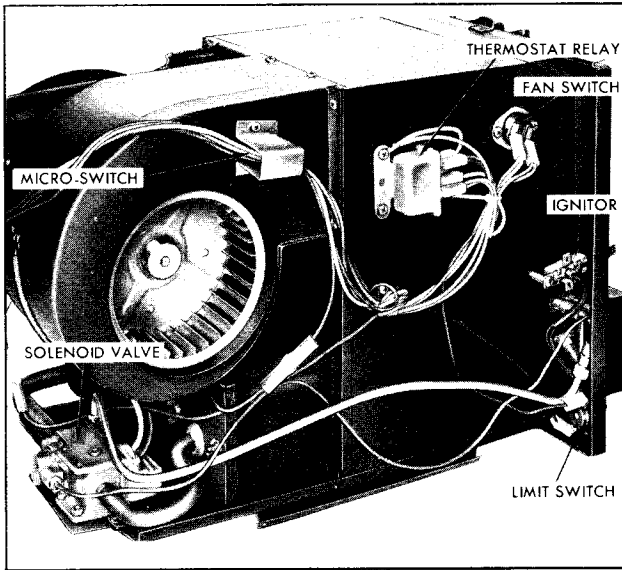

*Furnace Electrical Controls*

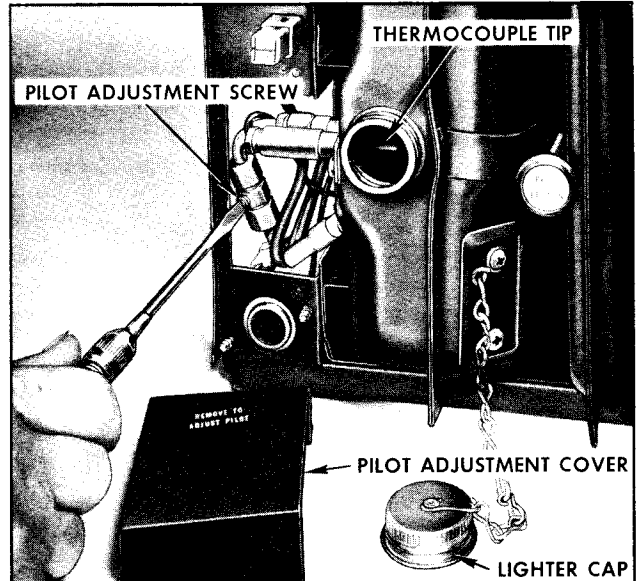

*Furnace Pilot Adjustment*

operate furnace with valve partly opened as proper operation depends on valve being fully open.

**NOTE:** If relighting furnace, close furnace manual valve for 5 minutes, then open manual valve and proceed to next step.

3. Remove lighter cap. Depress reset button and hold in. Pump igniter until pilot lights.

4. Continue to hold in reset button for 30 seconds after pilot is lighted.

5. Install lighter cap.

6. Set thermostat to desired temperature.

**NOTE:** Furnace pilot may be lit by match if desired, through lighter cap opening.

### SHUTTING OFF FURNACE

- To shut off furnace set thermostat to "OFF" position and close manual valve.
- Always perform these steps as a precaution when the furnace will not be in use.

### FURNACE OPERATING TIPS

#### Lack of Heat—Main Burner Out

The most common reason—pilot is out. This can be caused by:

1. L.P.G. tank empty or turned off.
2. Pilot not adjusted properly.
3. Clogged pilot orifice.
4. Malfunctioning micro-switch.
5. Weak thermocouple or safety valve.
6. Air leakage from combustion chamber or lack of air.

If pilot is going out when the burner comes on, it is usually:

1. Not enough primary air.
2. Malfunctioning micro-switch.

If pilot is going out two or three minutes after burner comes on:

1. Indicates a shorted fan switch.
2. Be sure thermostat is not set too low and all wires are connected to it.

### PILOT ADJUSTMENT

1. Remove lighter cap.
2. Remove pilot adjustment cover.
3. Rotate pilot adjustment screw to where the pilot flame just envelopes the thermocouple tip.

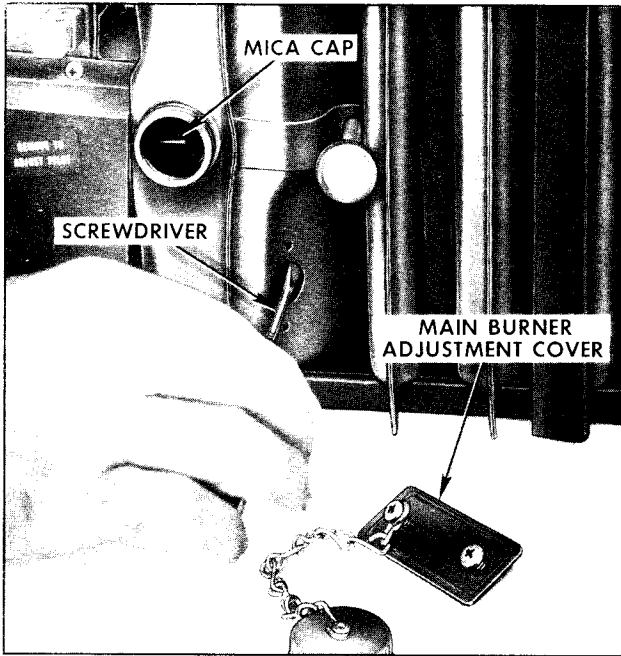

*Furnace Main Burner Adjustment*

## MAIN BURNER ADJUSTMENT

1. Install a mica cap to view condition of flame while adjusting and to maintain proper burning conditions.
2. Remove main burner adjustment cover just below and to right of lighter cap.
3. A small slotted screw must be adjusted with a screwdriver.
4. Adjust until a slight trace of orange can be seen at the top of the burner flame. Turning screw counterclockwise adjusts burner for less primary air. Turning screw clockwise adjusts burner for more primary air.

**NOTE:** The symptoms of improper adjustment are:

- a. Too little air—sooting on exterior vent and a distinct yellow and floating flame.
  - b. Too much air—howling or screeching noise when burner is on.
5. Replace mica cap with metal lighter cap.

## FURNITURE

### DOUBLE DINETTE

The double dinette easily converts to a double bed. To prepare the bed, take the following steps:

- Slightly raise the aisle end of the table and fold the attached leg under all the way.



*Double Dinete (Dining Position)*



*Double Dinette (Disengaging Table from Wall)*

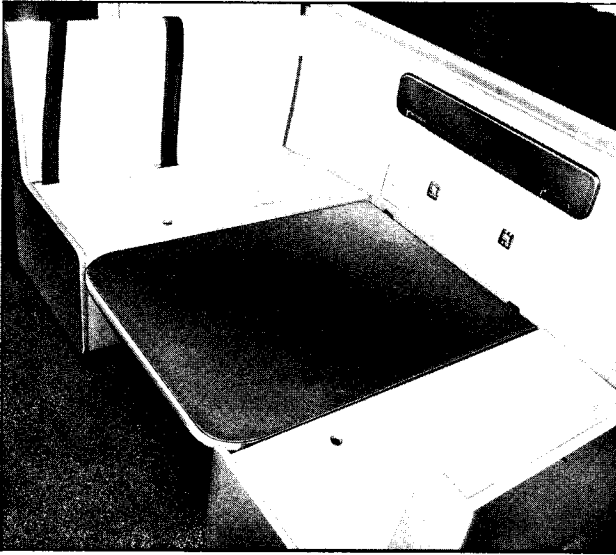

*Double Dinette (Preparation for Sleeping Position)*



*Front Davo*

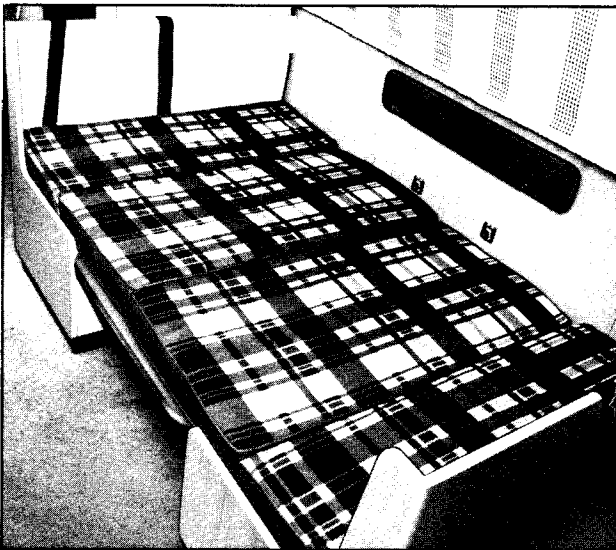

*Double Dinette (Sleeping Position)*



*Front Davo (Converted to Bunks)*

- The two support straps can now be hooked to the eyes provided in the ceiling.

### **SINGLE DINETTE**

The optional single dinette converts to a single bed in the same manner as the double dinette.

### **FRONT DAVO**

The front Davo converts into two bunk beds. To prepare the Davo for sleeping, take the following steps:

- Swing the back support out from the wall.
- Unfold the additional section on the back support to bring it to full width.

### **SWIVEL CHAIRS**

If the Motor Home is equipped with the swivel chairs in the living area, they are operated in the same manner as the seats in the driver's compartment. They should be locked in position before driving off.

### **PERMANENT DOUBLE BED**

The Motor Home comes standard with a permanent double bed in the rear of the vehicle.



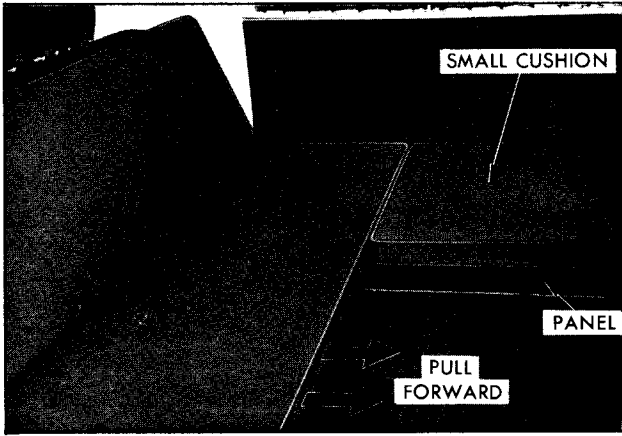

*Rear Goucho*

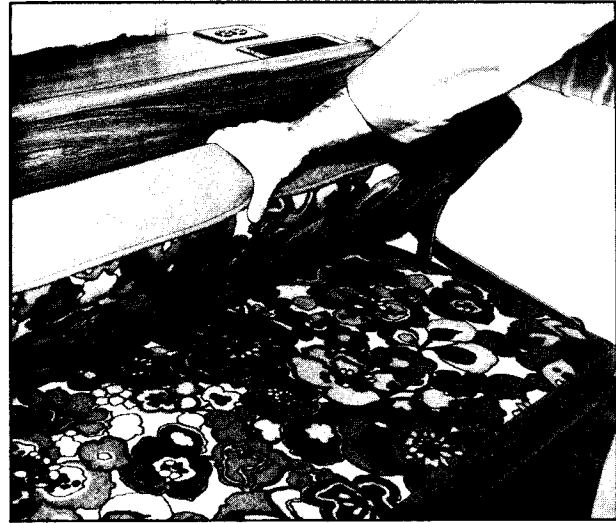

*Preparing Settee for Sleeping*



*Side Facing Settee*

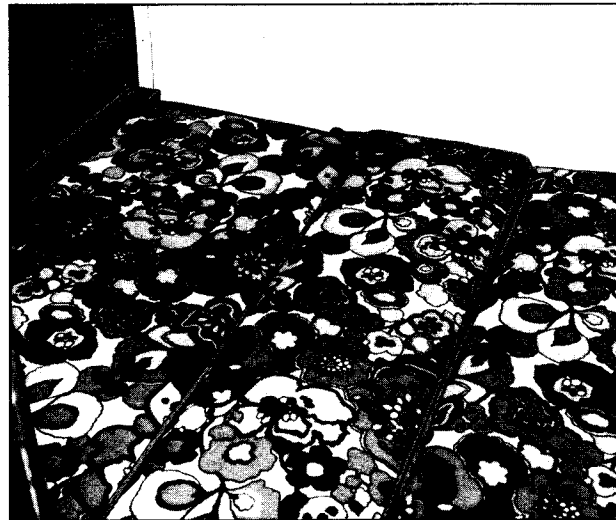

*Settee in Sleeping Position*

**REAR GOUCHO**

The optional rear goucho can be converted into a double bed. To prepare the goucho for sleeping perform the following:

- Remove small cushion and panel from left side of goucho.
- Pull the bottom of the goucho forward. The back support and cushions will pull down into the sleeping position.

**SIDE FACING SETTEE**

The rear side-facing settee converts into a double bed for sleeping. This is done by grasping

the top of one of the backrests and pulling it up and toward the center of the vehicle. The mechanism will automatically flip the armrest to the proper position between the seats. The other side will fold down in a similar manner. This will form the double bed as shown.

To convert it back to the sitting position grasp the center edge of the cushion and lift. The linkage will flip the backrest to the sitting position. Repeat the procedure on the opposite side.

# IN CASE OF EMERGENCY

## FOUR-WAY HAZARD WARNING FLASHER

- Use the warning flasher to warn other drivers any time your vehicle becomes a traffic hazard, day or night.
- Avoid stopping on the roadway, if possible.
- Turn on the hazard warning flasher by pushing in on the button located on the column just below the steering wheel. Flasher can be actuated with engine ignition either off or on.
- If the brake pedal is depressed, the lights will not flash but glow continuously instead.
- To cancel the flasher, pull the button outward.

## EMERGENCY STARTING

- Engine cannot be started by towing or pushing the vehicle.
- If only main (automotive) battery is discharged, set battery switch on instrument panel on "BAT BOOST," this supplies current from the auxiliary (living area) battery. Return switch to "BAT NORMAL" position if jump starting is still necessary.
- If both main and auxiliary batteries are discharged and the Motor Home is equipped with an optional motor generator, the auxiliary (living area) battery will be recharged by operating the motor generator with the battery switch in the "BAT NORMAL" position. This allows your power converter to charge the auxiliary battery.

Leave the battery switch in the "BAT NORMAL" position for approximately 30 minutes with the motor generator operating. Then change the battery switch to "BAT BOOST" position and start vehicle as you would normally. When vehicle has started

return battery switch to "BAT NORMAL" position.

- To start the vehicle when both the Energizers (batteries) are discharged, use a single battery or Energizer of the same nominal voltage (12 volts) as the discharged battery, with suitable jumper cables.
- Make connections as set forth below under "Jump Starting With Auxiliary (Booster) Battery" to lessen the chance of personal injury or property damage.

DO NOT use these instructions with any vehicle having a positive ground electrical system—either to start your Motor Home or the other vehicle—an explosion may result which could cause personal injury or property damage. All General Motors cars, trucks, and Motor Homes have negative ground electrical systems and can be used to jump start one another. If you cannot determine how the other vehicle is grounded (by checking specifications in owner's manual, etc.) we recommend that you attempt no jump starting with that vehicle.



*Hazard Warning Flasher*

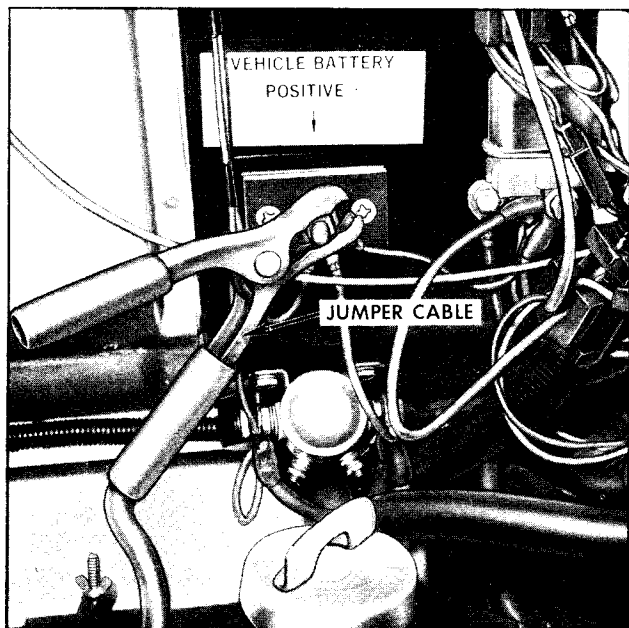

*Connecting Jumper Cable to "VEHICLE BATTERY POSITIVE" Stud*

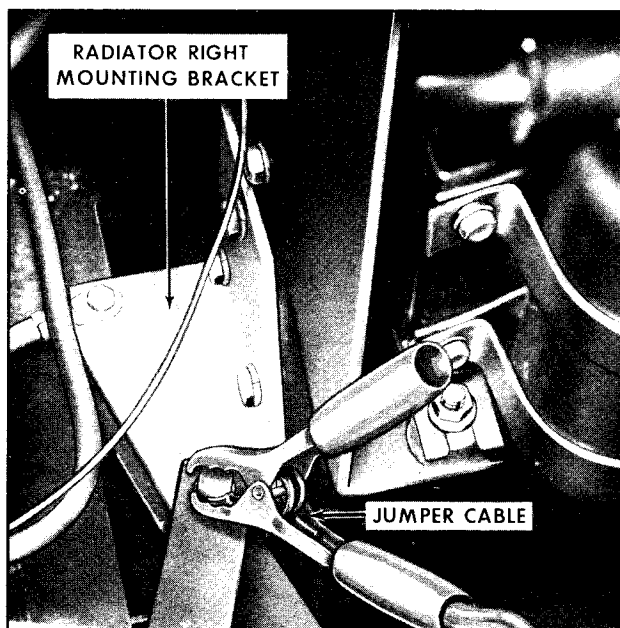

*Connecting Jumper Cable to Right Radiator Mounting Bracket*

### CAUTION

Never expose battery to open flame or electric spark—battery action generates hydrogen gas which is flammable and explosive. Don't allow battery fluid to contact skin, eyes, fabrics, or painted surfaces—fluid is a sulfuric acid solution which could cause serious personal injury or property damage. Wear eye protection when working with battery.

Remove rings, metal watchbands and other metal jewelry before jump starting or working around a battery, and be careful in using metal tools—if such metal should contact the positive battery terminal (or metal in contact with it) and any other metal on the vehicle a short circuit may occur which could cause personal injury.

### JUMP STARTING WITH AUXILIARY (BOOSTER) BATTERY

Both booster and discharged battery should be treated carefully when using jumper cables. Follow exactly the procedure outlined below, being careful not to cause sparks:

1. Set parking brake and place transmission in "PARK." Turn off lights, heater and other electrical loads.

2. Remove vent caps from both the booster and the discharged batteries. Lay a cloth over the open vent wells of each battery. These two actions help reduce the explosion hazard always present in either battery when connecting "live" booster batteries to "dead" batteries.

3. Attach one end of one jumper cable to the positive terminal of the booster battery (identified by a red color "+" or "P" on the battery case, post or clamp) and the other end of same cable to positive terminal junction block stud, marked "VEHICLE BATTERY POSITIVE." This is located behind the right access door above the batteries. Do NOT permit vehicles to touch each other, as this could establish a ground connection and counteract the benefits of this procedure.

4. Attach one end of the remaining negative cable to the negative terminal (black color, "-" or "N") of the booster battery, and the other end to the right radiator mounting bracket (do not connect directly to negative post of dead battery). Make sure that clamps from one cable do not inadvertently touch the clamps on the other cable. Do not lean over the battery when making this connection.

Reverse this sequence exactly when removing the jumper cables. Re-install vent caps and throw cloths away as the cloths may have corrosive acid on them.

## CAUTION

Any procedure other than the preceding could result in: (1) personal injury caused by electrolyte squirting out the battery vents, (2) personal injury or property damage due to battery explosion or electrical burns, (3) damage to the charging system of the booster vehicle or of the immobilized vehicle.

## ENGINE COOLANT CAUTION:

- To avoid the danger of being burned, do not remove radiator cap while engine and radiator are still hot, because the cooling system will blow out scalding fluid and steam under pressure.
- Do not remove radiator cap to check engine coolant level; check coolant visually at the see-through coolant reservoir.
- Proper coolant level at normal engine operating temperature is between the "FULL" and "ADD" marks on the reservoir.
- Coolant should be added only to the reservoir (see **SERVICE & MAINTENANCE** section for details).

## JACK USAGE INSTRUCTIONS

### CAUTIONS

1. Follow jacking instructions in order to reduce the possibility of serious personal injury.
2. The jack is designed for use only when changing wheels.
3. Never get beneath the vehicle when using jack.
4. Do not start or run engine while vehicle is on jack.

### INSTRUCTIONS

- Park on level surface and set parking brake firmly.
- Set transmission in "PARK".
- Activate Hazard Warning Flasher.
- Jack, jack chain, handle, "jacking pad" (wooden block), and lug wrench are located under dinette seat.

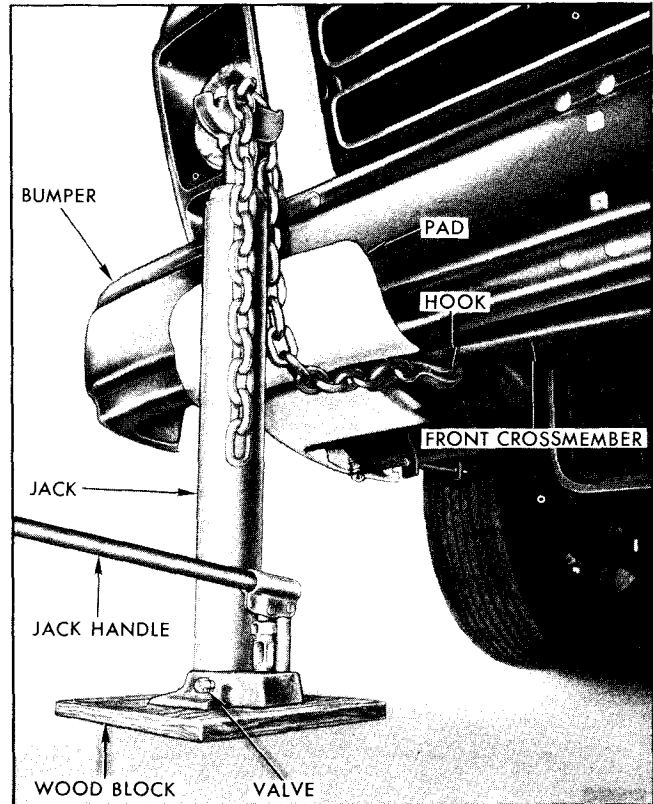

*Jacking at Front of Motor Home*

- Block both front and rear of the wheel diagonally opposite the jack position.
- Loosen but do not remove wheel nuts.
- **JACKING AT FRONT**—Place hydraulic jack on wood block near energy absorbing front bumper bracket. Place hook at flange of front cross-member. Pass chain under bumper and adjust chain length to snug fit on fork on top of jack.
- **JACKING AT REAR**—Place hydraulic jack on wood block close to rear suspension bracket (see next page). The hook is placed in the drainage slot under bracket. Adjust chain length so link will fit in fork at top of jack.
- Close valve at base of jack and insert jack handle.
- Always operate jack with slow, smooth motion.
- Raise vehicle so tire just clears surface, replace wheel and slightly tighten wheel nuts.
- Open valve at base of jack to lower, then fully tighten wheel nuts. Proper torque is 250 foot pounds.

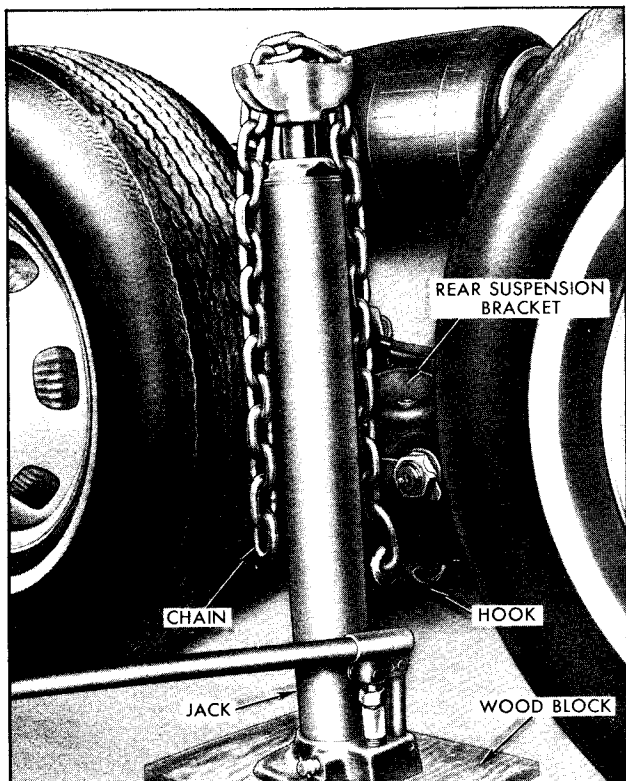

*Jacking at Rear of Motor Home*

**CAUTION**

Use lug wrench provided to tighten wheel nuts securely. (Follow the nut tightening sequence shown in the SERVICE AND MAINTENANCE section). At the earliest opportunity have wheel nut torque checked. This is necessary to help prevent loosening or stripping of the wheel nuts.

**TOWING MOTOR HOME**

Proper lifting or towing equipment is necessary to prevent damage to the GMC Motor Home during any towing operation. State (Provincial in Canada) and local laws applicable to vehicles in tow must also be followed. Motor Home service outlets can advise you on the selection of a knowledgeable towing concern.

Your Motor Home may be towed on all six wheels at speeds of less than 35 MPH, for distances up to 50 miles, provided final drive, axle, and transmission are otherwise normally operable. For such towing, parking brake must be released, transmission must be in neutral, and the ignition key turned to OFF position.

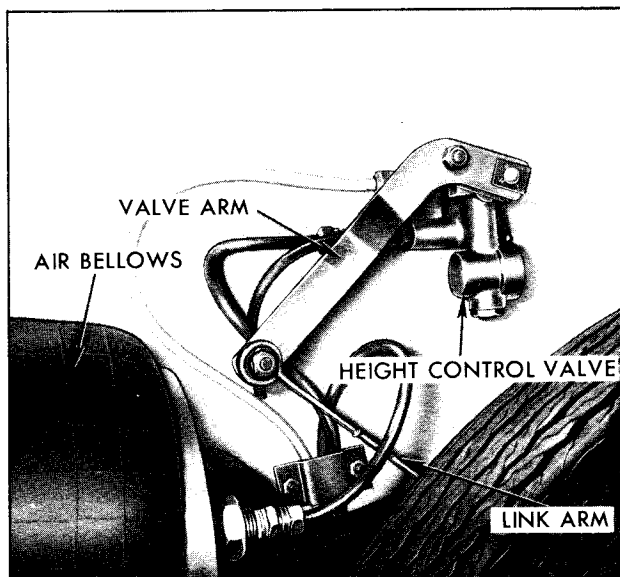

*Location for Disconnecting Height Control Valve Link Arm*

**TOWING AT FRONT**

**NOTE:** Attachments must be to frame front crossmember of the Motor Home, not to bumpers or bracketing. Separate safety chains or cables should be used. Care must be taken in installation of chains to ensure that they do not cause damage. Remember that power brake and steering assists will not be available when engine is inoperative.

Certain other precautions are required when it is necessary to tow with the front drive wheels lifted off the road. On Motor Homes equipped with the Power Level System, turn the valve dials, below the instrument panel, to "LOCK" position, thereby making the automatic height valves inoperative on the rear suspension. On Motor Homes not equipped with the optional Power Level System it will be necessary to disconnect the height control valve link arm at the rear suspension control arm (adjacent to the shock absorber stud) on each side of the vehicle. Raising front of vehicle so front wheels are four inches off the ground will provide about five-inch ground clearance at the rear when towing.

**TOWING AT REAR**

It is not recommended that vehicle be towed with the rear raised as this could result in suspension or crossmember damage.

## **FREING VEHICLE FROM SAND, ETC.**

If it becomes necessary to rock the Motor Home to free it from sand, mud, or snow, move the transmission selector lever from "D" to "R" in a repeat pattern while simultaneously applying moderate pressure to the accelerator. Do not race engine. For best possible traction, avoid spinning wheels when trying to free the Motor Home. The use of GM Liquid Tire Chain is recommended for temporary assistance when traction is lost on ice or snow.

### **CAUTION**

**Wheel spin should not exceed 35 MPH as indicated on the speedometer. Unless care is taken in limiting wheel spin, one spinning wheel can reach excessive speeds, resulting in possible tire disintegration or differential failure, which could cause personal injury or extensive vehicle damage.**

### **EMERGENCY EXIT**

The rear window of the Motor Home in an emergency can be used as an exit. To use the emergency exit, pull the ring located at the top center of the rear window until window seal is removed, and then push the glass out of the frame. Do not pull ring except in case of emergency. The window is not hinged, and it is designed to be pushed out. Take care that window

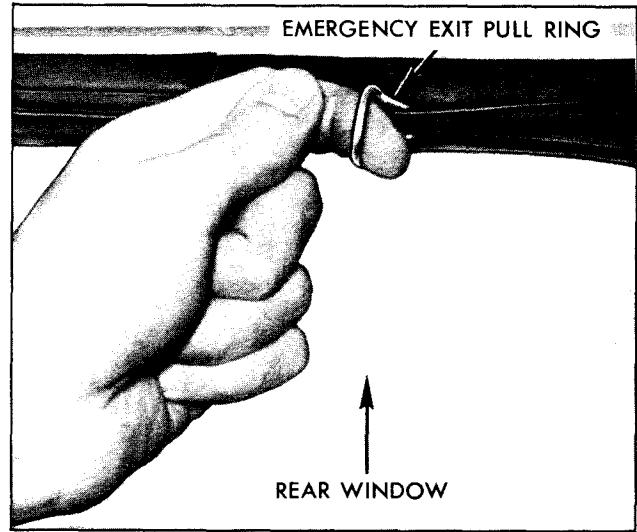

*Emergency Exit Pull Ring*

will not fall on anyone outside the Motor Home. Be careful of possible broken glass on ground when exiting from the vehicle.

### **FIRE EXTINGUISHER**

The optional, 2½ pound, dry chemical, fire extinguisher is located in the front of the vehicle near the passenger seat. If your vehicle is a model 260 equipped with a closet near the entrance door, the fire extinguisher will be located in this closet.

It is recommended that you be familiar with the operating instructions located on the fire extinguisher.

**For continuing satisfaction keep your Motor Home all GM. General Motors Parts are identified by one of these trademarks:**





# APPEARANCE CARE

## CARE AND CLEANING OF INTERIOR

### GENERAL INFORMATION

Dust and loose dirt that accumulate on interior fabric trim should be removed frequently with a vacuum cleaner, whisk broom or soft brush. Vinyl or leather trim should be wiped clean with a damp cloth. Normal cleanable trim soilage, spots or stains can be cleaned with the proper use of trim cleaners available through General Motors Dealers or other reputable supply outlets.

**IMPORTANT:** Do not use commercial paint, chrome or glass cleaners on interior bright trim or painted surfaces. If cleaning is required, lukewarm water and a neutral soap may be used.

Before attempting to remove spots or stains from upholstery, determine as accurately as possible the nature and age of the spot or stain. Some spots or stains can be removed satisfactorily with water or mild soap solution (refer to "Removal of Specific Stains" later in this section). For best results, spots or stains should be removed as soon as possible.

Some types of stains or soilage such as lipsticks, some inks, certain types of grease, mustard, etc., are extremely difficult and, in some cases, impossible to completely remove. When cleaning this type of stain or soilage, care must be taken not to enlarge the soiled area. It is sometimes more desirable to have a small stain than an enlarged stain as a result of attempted cleaning.

### CAUTION

When cleaning interior do not use volatile cleaning solvents such as: acetone, lacquer thinners, enamel reducers, nail polish removers; or such cleaning materials as laundry soaps, bleaches or reducing agents (except as noted in the instructions on "Cleaning Fabrics" and "Removal of Specific Stains.") Never use carbon tetrachloride, gasoline, or naphtha for any cleaning purpose. The above

materials may be toxic or flammable, or may cause damage to interior.

### VACUUM CLEANER

The Motor Home integral vacuum cleaner (optional on Model 260) operates on 120-volt current. The vehicle must be connected to an external power source or the motor generator must be in operation in order to operate the vacuum cleaner.

Vacuum cleaner components are stored in the side of the refrigerator module near the entrance door. The vacuum cleaner storage cabinet contains a long flex hose, wand, and a wide assortment of wand attachments including one for shag carpeting.

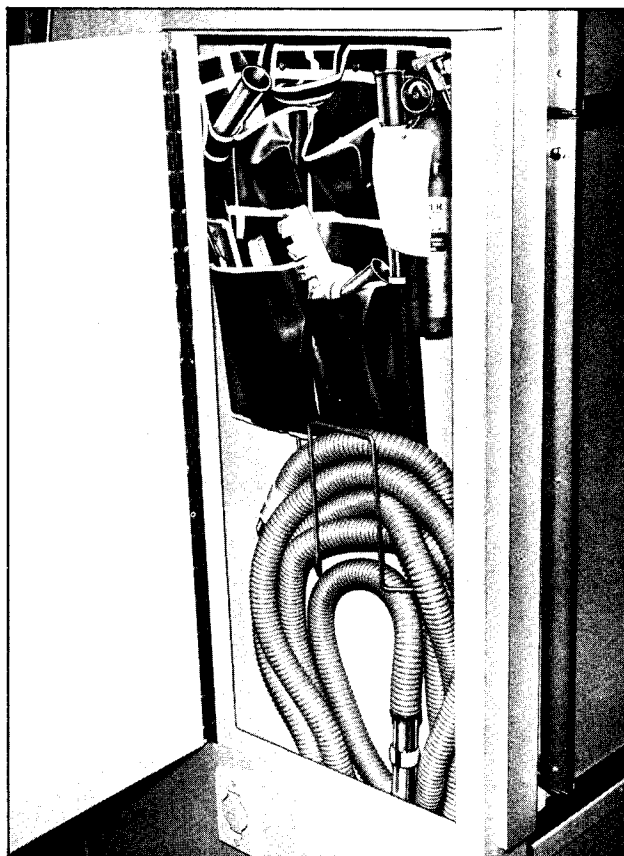

*Vacuum Cleaner Components*



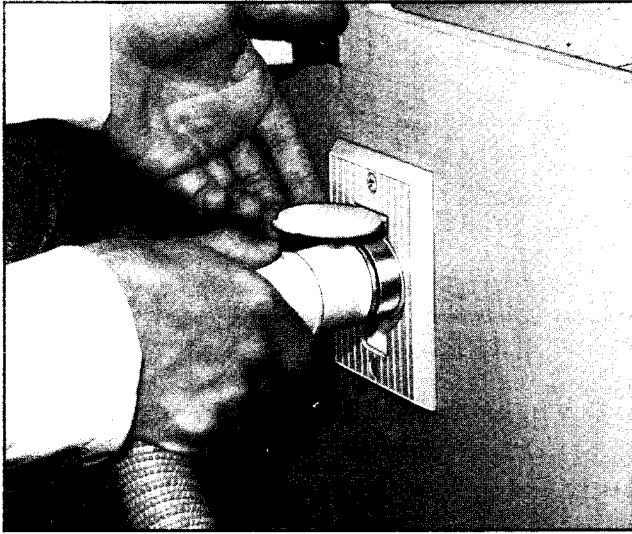

*Connecting Flex Hose  
to Wall Socket*

To operate the vacuum system, remove flex hose from the cabinet, lift vacuum inlet hinge cap, just under the storage cabinet, and insert the proper end of the flex hose. At this point the vacuum system will be operating and is used in the same manner as any household vacuum cleaner.

### **LAP BELT CARE**

- Clean only with mild soap solution and lukewarm water.
- Do not bleach or dye belts since this may severely weaken them.

### **INTERIOR GLASS**

The interior glass surface should be cleaned on a periodic basis for continued good visibility. A commercial household glass cleaning agent containing ammonia will remove normal tobacco smoke and dust films sometimes caused by ingredients used in vinyls, plastics, or other interior trim materials.

### **KITCHEN SINK**

The stainless steel sink should be cleaned with a liquid or finely ground powder. Scouring powder is not recommended for stainless steel and will ruin the finish. Stainless steel cannot be harmed by boiling water. However, salt, mustard, mayonaise and catsup will cause pitting and should be cleaned off immediately.

## **CLEANING FABRICS**

**IMPORTANT:** Be sure vehicle is well ventilated while using the following cleaning agents. Follow manufacturer's recommendations in using such products.

### **CLEANING FABRICS WITH CLEANING FLUID**

This type of cleaner should be used for cleaning stains containing grease, oil, or fats. Excess stain should be gently scraped off trim with a clean dull knife or scraper. Use very little cleaner, light pressure, and clean cloths (preferably cheesecloth). Cleaning action with cloth should be from outside of stain towards center and constantly changing to a clean section of cloth. When stain is cleaned from fabric, immediately wipe area briskly with a clean absorbent towel or cheesecloth to help dry area and prevent a cleaning ring. If ring forms, immediately clean entire area or panel section of the trim assembly.

**NOTE:** Sometimes a difficult spot may require a second application of cleaning fluid followed immediately by a soft brush to completely remove the spot.

### **CLEANING FABRICS WITH DETERGENT FOAM CLEANERS**

This type of cleaner is excellent for cleaning general soilage from fabrics and for cleaning a panel section where a minor cleaning ring may be left from spot cleaning. Vacuum area to remove excess loose dirt. Always clean at least a full trim panel or section of trim. Mask adjacent trim along stitch or weld lines. Mix detergent type foam cleaners in strict accordance with directions on label of container. Use foam only on a clean sponge or soft bristle brush—Do not wet fabric excessively or rub harshly with brush. Wipe clean with a slightly damp absorbent towel or cloth. Immediately after cleaning fabric, dry fabric with a dry towel or hair dryer. Rewipe fabric with dry absorbent towel or cloth to restore the luster of the trim and to eliminate any dried residue.

### **REMOVAL OF SPECIFIC STAINS**

**CANDY**—Chocolate, use cloth soaked in lukewarm water; other than chocolate, use very hot water. Dry if necessary, clean lightly with fabric cleaning fluid.

**CHEWING GUM**—Harden gum with ice cube and scrape off with dull knife. Moisten with fabric cleaning fluid and scrape again.

**FRUIT STAINS, COFFEE, LIQUOR, WINE, SOFT DRINKS, ICE CREAM AND MILK**—Wipe with cloth soaked in cold water. If necessary, clean lightly with fabric cleaning fluid. Soap and water is not recommended as it might set the stain.

**CATSUP**—Wipe with cloth soaked in cool water. If further cleaning is necessary, use a detergent foam cleaner.

**GREASE, OIL, BUTTER, MARGARINE AND CRAYON**—Scrape off excess with dull knife. Use fabric cleaning fluid.

**PASTE OR WAX TYPE SHOE POLISH** — Light application of fabric cleaning fluid.

**TAR**—Remove excess with dull knife, moisten with fabric cleaning fluid, scrape again, rub lightly with additional cleaner.

**BLOOD**—Wipe with clean cloth moistened with cold water. Use no soap.

**URINE**—Sponge stain with lukewarm soap suds from mild neutral soap on clean cloth, rinse with cloth soaked in cold water; saturate cloth with one part household ammonia and five parts water, apply for one minute, rinse with clean, wet cloth.

**VOMITUS**—Sponge with clean cloth dipped in clean, cold water. Wash lightly with lukewarm water and mild neutral soap. If odor persists, treat area with a water-baking soda solution (one teaspoon baking soda to one cup of tepid water). Rub again with cloth and cold water. Finally, if necessary, clean lightly with fabric cleaning fluid.

## EXTERIOR APPEARANCE CARE

The best way to preserve the finish is to keep it clean. Normally only frequent washings are required to maintain its original beauty. Wash the vehicle with either cold or warm (never hot) water, not in the direct rays of the sun and not while the sheet metal surfaces are hot. Never wipe dirt from dry painted surfaces because this may scratch the finish. The use of strong soaps and chemical detergents should be avoided. Cleaning agents should be promptly flushed from the surface and not allowed to dry or they may streak the finish.

### BRIGHT METAL PARTS

Wash all bright metal parts frequently to alleviate the destructive forces of salt, calcium chloride, salt air, exhaust gases, and industrial fallout (which may be corrosive).

Use lukewarm water and mild soap, not with a strong alkali solution, rinse thoroughly. Avoid use of bright metal polishes containing harmful abrasives.

**NOTE:** In severe cases, road oil and tar may be removed from bright metal parts by a chemical cleaner which is specified safe to use on all acrylic finishes.

A protective coating such as GM Chrome Gard may be applied on clean chrome surfaces which are stain and rust free. If necessary, GM Chrome Cleaner and Polish may be used to remove rust from chrome plated parts before applying a protective coating.

### EXTERIOR GLASS

Never wipe glass with dry paper or cloth. Do not operate wipers when glass is dry. Dirt and insects can be removed with clear water or with a mild liquid household cleaner. The use of harsh abrasives should be avoided. Periodic inspection and replacement of wiper blades will reduce the possibility of the windshield becoming scratched and will assure clear vision under adverse driving conditions.

## POLISHING AND WAXING

Even though the acrylic enamel on your Motor Home is durable, under certain conditions it may be advisable to wax or polish your vehicle to provide added protection. Calcium chloride and other salts, road oil and tar, tree sap, chemicals from factory chimneys and other foreign matter may damage any known vehicle finish if allowed to remain in contact with the paint film.

Prompt washing may not remove thoroughly these deposits and, particularly in geographical areas where exposure conditions are severe. Properly applied polishes and waxes of known quality will provide the best protection. Most GMC Motor Home service outlets offer polishes or waxes which can be of real value in maintaining a good paint finish.

**NOTE:** Some chemical cleaners, used for removing road oil and tars from painted surfaces, are detrimental to acrylic enamel finishes. When

purchasing a cleaner, make sure the instructions on the container specifically state that the contents can be used on any acrylic enamel finish.

## TOUCH-UP PAINT

Nicks and chips in paint surfaces should be touched up before weathering action begins. The best time to detect them is right after the Motor Home has been washed. Touch-Up Paint to match your Motor Home's color is available at your GMC Motor Home service outlet.

## UNDERCOATING

Due to the fiberglass and aluminum body construction of the Motor Home added protection by additional undercoating is not necessary. However, if you do wish to apply undercoating material, it should be kept off of all moving or rotating parts. It should also be kept off air conditioner fittings, body drain holes, exhaust systems, and plumbing.

**For continuing satisfaction keep your Motor Home all GM. General Motors Parts are identified by one of these trademarks:**



# SERVICE AND MAINTENANCE

## CAUTION

As with any machinery, extreme care should be taken when performing any inspection, maintenance or repairs so as to prevent accidental injury. Improper or incomplete servicing could result in vehicle or living area systems operational problems which may lead to personal injury, or damage to the vehicle or its equipment. Should you have any question about performing any service, have the service performed by a competent serviceman.

## ACCESSIBILITY

### EXTERIOR COMPARTMENTS

Your GMC Motor Home has an entrance door on the right side and six compartment

doors. Their locations are shown on the following illustrations, further information about each compartment's content is covered in those particular sections.

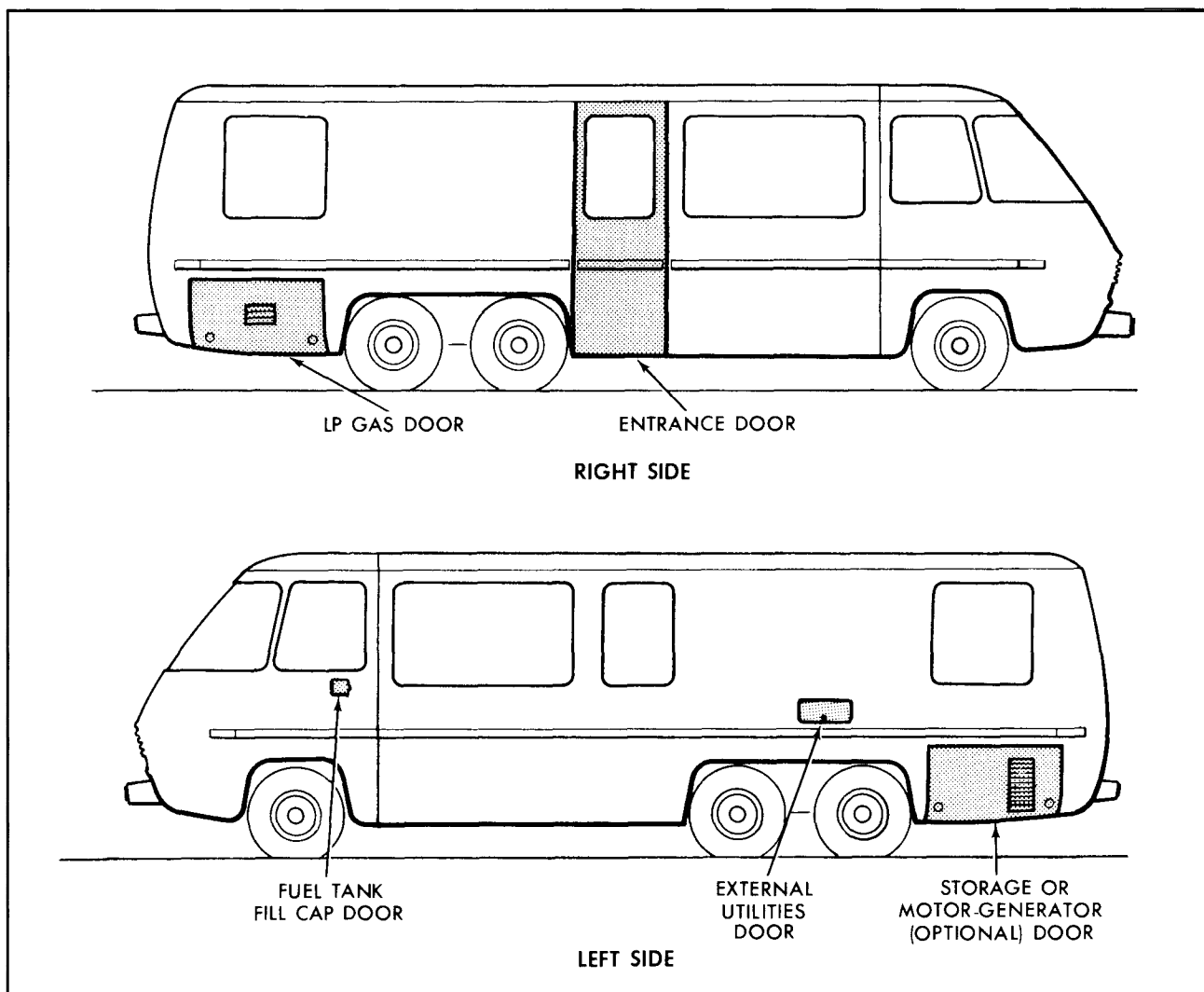

*Exterior Compartment Location (Typical)*

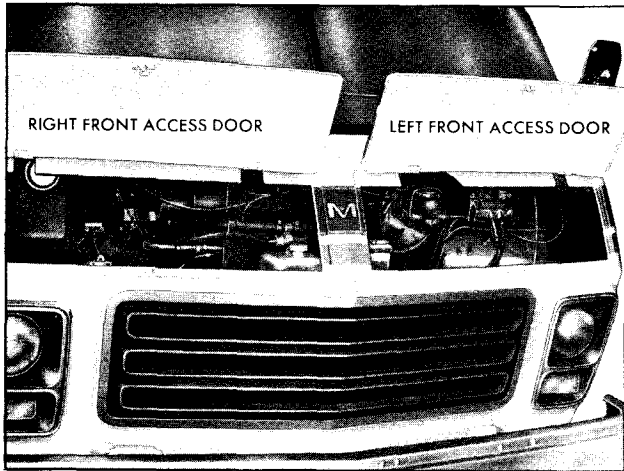

*Front Access Doors*

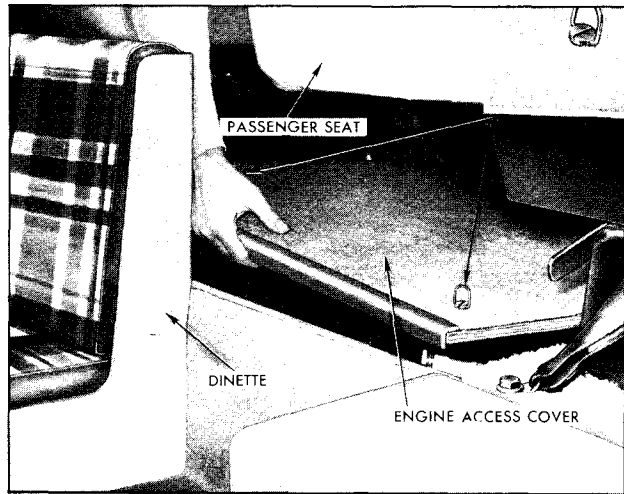

*Removing Engine Access Cover*

The external utilities door is designed to be secured and locked by a key operated lock. The storage or Motor Generator (optional) Door and the LP Gas Door are designed to be secured by latch mechanisms. Turn the latch knob to the left to open door and to the right to secure the door.

Be sure the doors are secured tightly to prevent their opening after vehicle is in motion.

There are two front access doors on your Motor Home. Turn the latch knob to the left to release each door. Items that can be checked or filled through the right access door are the batteries, engine oil fill, radiator, radiator cap, engine coolant reservoir and the air conditioner receiver-dehydrator sight glass (optional). Items that can be checked or filled through the left

access door are the windshield washer reservoir, brake master cylinder, engine oil dipstick and the air compressor.

Be sure to secure the access doors after closing them by turning the latch knob to the right to prevent the doors from opening after the vehicle is in motion.

**CAUTION**

**Before pouring fluid into any filler opening anywhere on the vehicle, or allowing anyone else to do so, make certain that the correct filler opening, and type of fluid has been selected. A wrong choice could result in serious personal injury or property damage.**

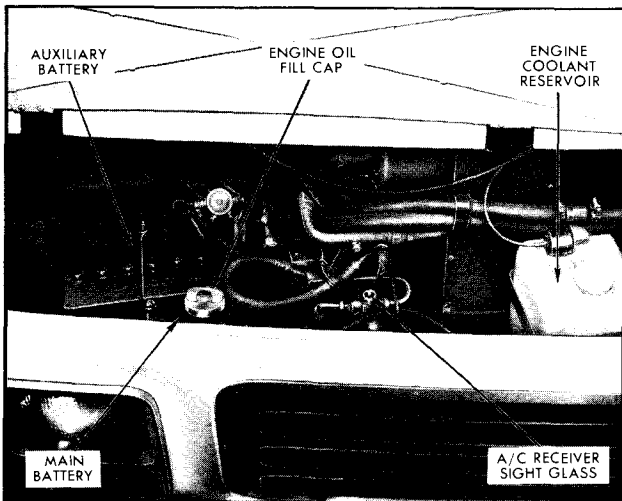

*Right Front Access Compartment*

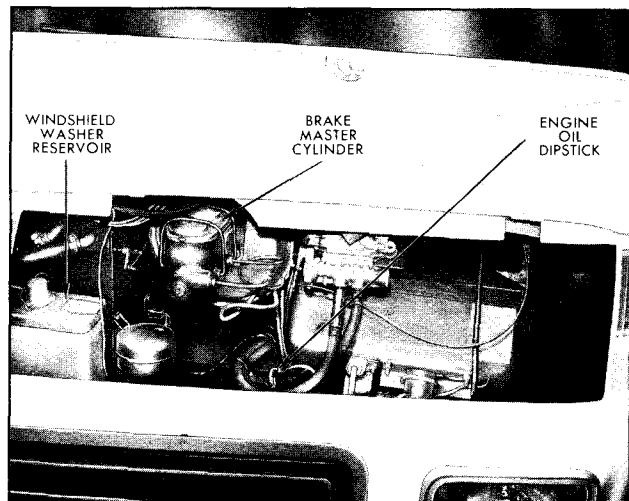

*Left Front Access Compartment*

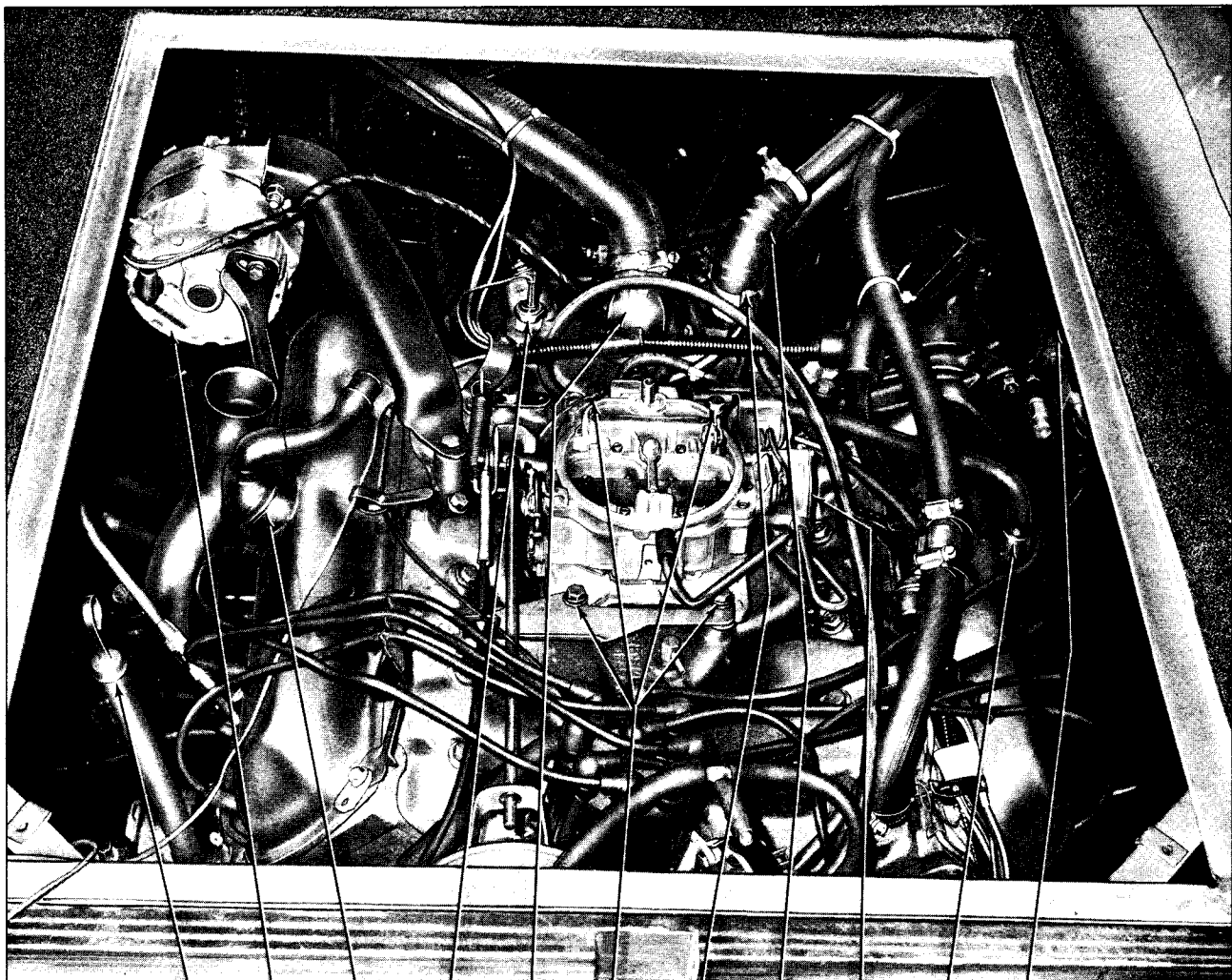

1 2 3 4 5 6 7 8 9 10 11

1 AUTOMATIC TRANSMISSION FLUID DIPSTICK & FILL TUBE  
 2 GENERATOR (DELCO TRON)  
 3 PCV FILTER  
 4 ENGINE TEMPERATURE SENDING UNIT  
 5 THERMOSTAT HOUSING  
 6 CARBURETOR ATTACHING BOLTS (4)

7 THERMAL VACUUM SWITCH  
 8 ENGINE OIL FILL HOSE & TUBE ASM.  
 9 CARBURETOR CHOKE COIL COVER  
 10 PCV VALVE  
 11 AIR CONDITIONING COMPRESSOR (OPTIONAL)

### *Engine Compartment*

#### **ENGINE ACCESSIBILITY**

Access to the engine is provided by an engine cover located between the driver and passenger seats. The cover is designed to be secured at the two rear corners by securing bolts. The securing bolts have rings and may be loosened or tightened by hand or screwdriver. The cover is de-

signed to be secured at the front by a retaining lip.

To remove the engine cover loosen the securing bolts and lift up using the wire loops. To install the engine cover place the cover in its frame and slide forward as far as possible. Tighten the securing bolts.

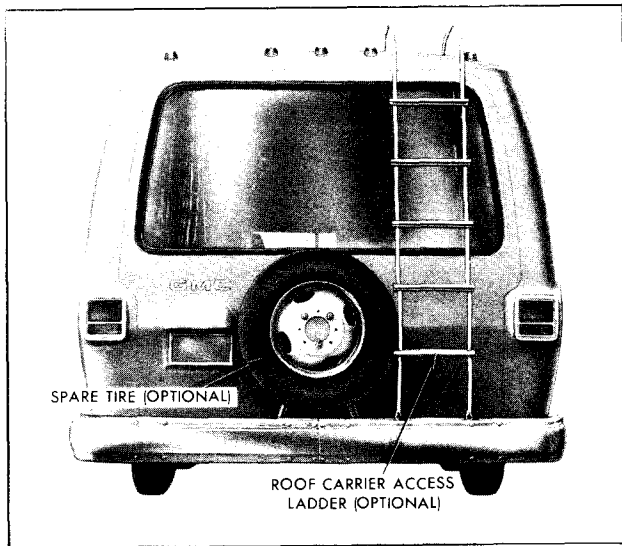

*Rear View of Motor Home*

**CAUTION**

It is essential that when installing the engine cover it be fully seated to its seal and secured by the lip at its forward edge and the securing bolts at its rearward edge. Do NOT allow cables, carpeting, floor mats or any other material

to interrupt the seal between the cover and the engine compartment. If the engine cover is not correctly installed and seated, engine exhaust could leak into the passenger compartment creating a safety hazard (see the carbon monoxide caution at the beginning of the section on STARTING AND OPERATING VEHICLE). If the engine must run with the cover off for maintenance purposes, care should be taken to assure that the vehicle's interior is well ventilated.

Refer to the "Complete Vehicle Maintenance Schedule" for service intervals and lubricant recommendations. Required checking and adjusting of the engine components is covered later in this section.

**ROOF CARRIER**

The optional roof carrier has a capacity of 250 lbs. The ladder is designed for gaining access to the roof carrier and should not be used for towing or as a luggage rack. Remember items stored in the roof carrier may protrude higher than other parts of the vehicle and create a clearance problem.

**HOISTING INSTRUCTIONS**

A twin post hoist of sufficient capacity and with proper adapters and/or fittings must be used.

Front hoisting position is the front engine crossmember.

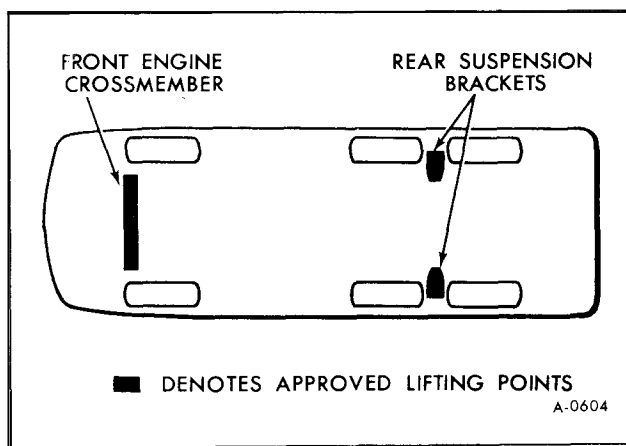

*Motor Home Hoisting Points*

Rear hoisting must be done at the rear suspension brackets. If an "I" beam type adapter is used it should be approximately 82 inches in length to gain adequate support at suspension brackets.

If vehicle is to be placed on safety stands for maintenance or repairs, the hoisting points should be used.

**CAUTION**

To help avoid serious damage to your Motor Home, the vehicle should be raised only on twin post hoists of 15,000 pounds or more total rated capacity, at the suspension points noted (see diagram). Before raising, check overhead clearance to see that it is sufficient for the Motor Home. Do NOT use the vehicle jack for hoisting or maintenance. It is designed for use only when changing tires.

### **NOTE**

Pages 67 through 72, which are missing, contained the "GMC Motor Home Maintenance Schedule." This schedule is now published separately as a folder (Form No. X-7415) and the information will apply to motor homes having engines certified for the year 1974.





## ONAN 4,000/6,000 WATT MOTOR GENERATOR MAINTENANCE SCHEDULE

SERVICE THESE ITEMS	AFTER EACH CYCLE OF INDICATED HOURS						
	8	100	200	400	500	1000	1500
General Inspection	4,000/6,000 watt						
Check Oil Level	4,000/6,000 watt						
Change Crankcase Oil		4,000/6,000 watt (1)					
Clean Air Cleaner		4,000/6,000 watt (1)					
Check Spark Plugs		4,000/6,000 watt					
Fuel Filter—Clean		4,000 watt			6,000 watt (2)		
Check Breaker Points		4,000 watt 6,000 watt(2)					
Clean Cooling Fins			4,000/6,000 watt (1)				
Change Oil Filter		6,000 watt (1)	4,000 watt (1)				
Replace Breaker Points			4,000 watt				
Clean Crankcase Breather			4,000 watt				
Replace Air Cleaner			4,000 watt (1)		6,000 watt (1)		
Remove Carbon From Heads			4,000 watt		6,000 watt		
Adjust Tappets				4,000 watt	6,000 watt		
Check Generator Brushes						4,000 watt	6,000 watt
Complete Reconditioning (If Required)						4,000 watt	6,000 watt

(1) Perform more often in extremely dusty conditions.

(2) Replace if necessary.

## KOHLER 4,000 WATT MOTOR GENERATOR MAINTENANCE SCHEDULE

SERVICE THESE ITEMS	AFTER EACH CYCLE OF INDICATED HOURS			
	8	50	100	200
General Inspection	X			
Check Oil Level	X			
Change Crankcase Oil (1)		X		
Clean Air Cleaner Element		X		
Replace Air Cleaner Element			X	
Check Spark Plugs			X	
Clean Cooling Fins				X
Check Breaker Points				X
Replace Fuel Filter			X	
General Tune-Up				X

(1) Initial oil change after 5 operational hours.

## RECOMMENDED FLUIDS & LUBRICANTS

USAGE	FLUID / LUBRICANT
Engine oil	High quality SE oil
Motor generator	High quality oil meeting both SE and CC requirements
Power steering system and pump reservoir. Includes windshield wiper motor	GM power steering fluid Part No. 1050017--if not available use DEXRON® automatic transmission fluid
Final drive	SAE-80 or SAE-90 GL-5 gear lubricant (SAE-80 in Canada)
Brake system and master cylinder	Delco Supreme 11 or, DOT-3 fluid or equivalent
Transmission shift linkage	Engine oil
Chassis lubrication	Chassis grease meeting requirements of GM 6031-M
Transmission	DEXRON® automatic transmission fluid
Parking brake cables	Chassis grease
Rear wheel bearings	Chassis grease meeting requirements of GM 6031-M
Body door hinge pins, hinges and latches at the front access doors, external utilities, generator/storage and LP gas doors. Gas fill door hinge	Engine oil
Windshield washer solvent	GM Optikleen washer solvent Part No. 1050001 or equivalent
Energizers (Batteries)	Colorless, odorless, drinking water
Engine coolant	Mixture of water and a high quality Ethylene Glycol base type anti-freeze conforming to GM Spec. 1899-M

NOTE: Fluids and lubricants identified with GM part numbers or GM specification numbers may be obtained from your GMC Motor Home Service Outlet.

# LUBRICATION DETAILS

## — ENGINE —

### ENGINE OIL AND FILTER RECOMMENDATIONS

- Use only SE engine oil.
- Refer to "Complete Vehicle Maintenance Schedule" for oil change and filter replacement intervals.
- See your GMC Motor Home service outlet for advice on the frequency of oil and filter changes under unusual driving conditions.

The recommendations in the "Complete Vehicle Maintenance Schedule" apply to the first change as well as subsequent oil changes. The oil change interval for your Motor Home engine is based on the use of SE oils and quality oil filters. Oil change intervals longer than those listed above will seriously reduce engine life and may affect GMC Truck & Coach's obligation under the provisions of the New Vehicle Warranty.

A high quality SE oil was installed in your engine at the factory. It is not necessary to change this factory-installed oil prior to the recommended normal change period. However, check the oil level more frequently during the break-in period since higher oil consumption is normal until the piston rings become seated.

**NOTE:** Non-detergent and other low quality oils are specifically not recommended. Only the use of SE engine oils and proper oil and filter change intervals assure you of continued proper lubrication of your Motor Home's engine.

### RECOMMENDED SAE VISCOSITY

- Single grade oils are preferred, however, multigrades such as SAE 10W-30 or 10W-40 are also acceptable.
- SAE 5W-20 oils are not recommended for sustained high speed driving.
- SAE 5W-30 oils (if available) may be used if extreme low temperatures are anticipated.

### SUPPLEMENTAL ENGINE OIL ADDITIVES

The regular use of supplemental additives is specifically not recommended and will increase operating costs. However, supplemental additives are available that can effectively and economically solve certain specific problems without causing other difficulties. For example, if higher detergency is required to reduce varnish and sludge deposits resulting from some unusual operational difficulty, a thoroughly tested and approved additive—"Super Engine Oil Supplement"—is available at your GMC Motor Home service outlet. In the event of an operational problem, consult your service outlet for advice before using supplemental additives.

### CHECKING OIL LEVEL

The engine oil should be maintained at the proper level. The best time to check it is before operating the engine or as the last step in a fuel stop. This will allow the normal oil accumulation in the engine to drain back into the crankcase.

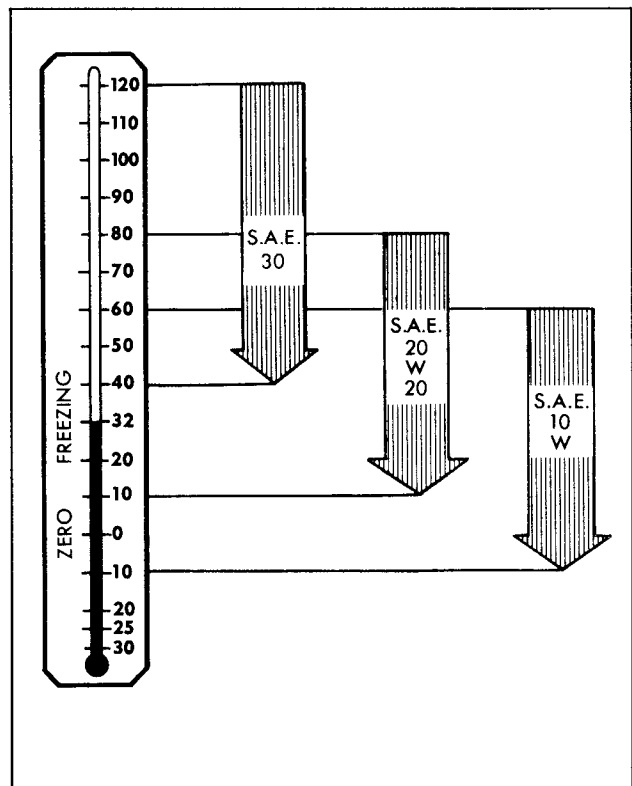

*Engine Oil Viscosity Chart*

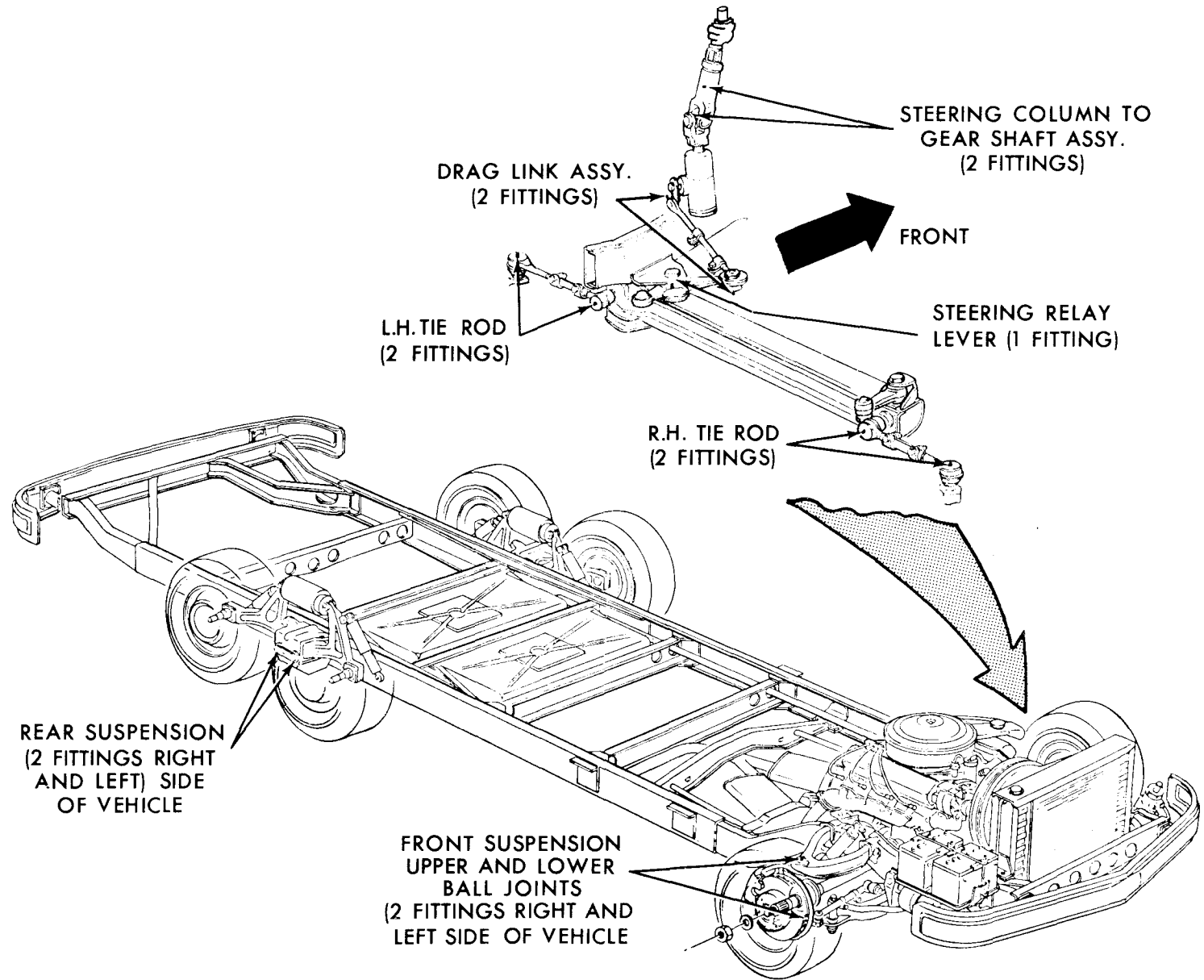

*Location of Chassis Lubrication Fittings*

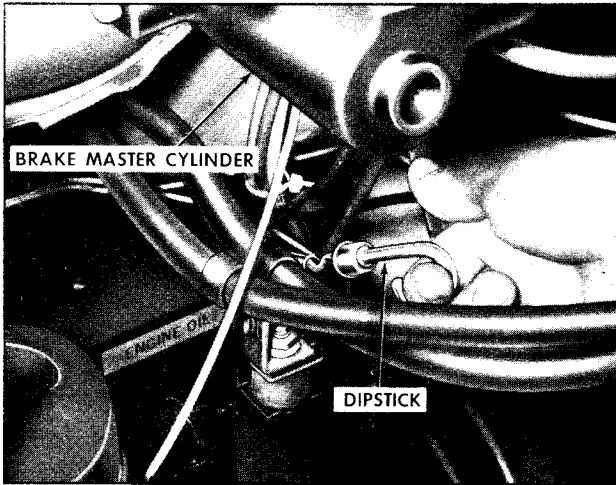

*Removing Engine Oil Dipstick*

To check the level, remove the oil level dipstick located inside the left front access door, wipe it clean and reinsert it fully for accurate reading. The oil level dipstick is marked "FULL" and "ADD." The oil level should be maintained within the margin, neither going above the "FULL" line nor below the "ADD" line. Reseat the dipstick firmly after taking the reading. One (1) quart will raise the oil level from "ADD" to "FULL."

NOTE: The oil dipstick is also marked "USE SE ENGINE OIL," as a reminder to use only SE oils.

## TRANSMISSION

The transmission dipstick and fill tube is located under the engine access cover on the left side of the engine.

Use only automatic transmission fluids identified with the mark DEXRON®. These fluids have been specially formulated and tested for use in your automatic transmission, and are available from your GMC Motor Home service outlet or local service station.

Check the fluid level at each engine oil change period. To make an accurate fluid level check:

1. Drive Motor Home several miles, making frequent starts and stops, to bring transmission up to normal operating temperature (approx. 180-190° F.).
2. Park Motor Home on a level surface.
3. Apply parking brake.
4. Place selector lever in "PARK" and leave engine running.
5. Open all but the two rear windows, then remove engine cover.

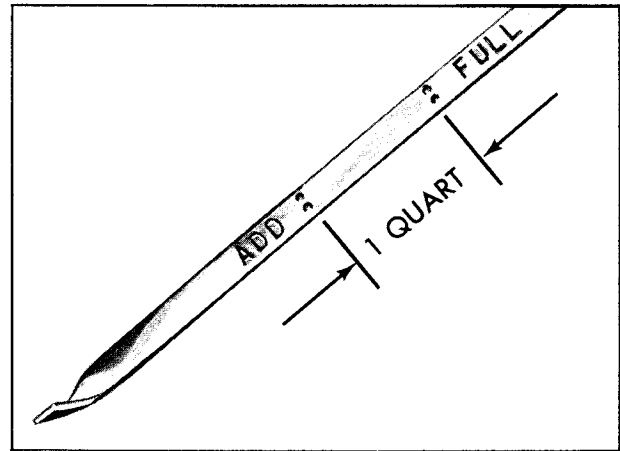

*Engine Oil Dipstick*

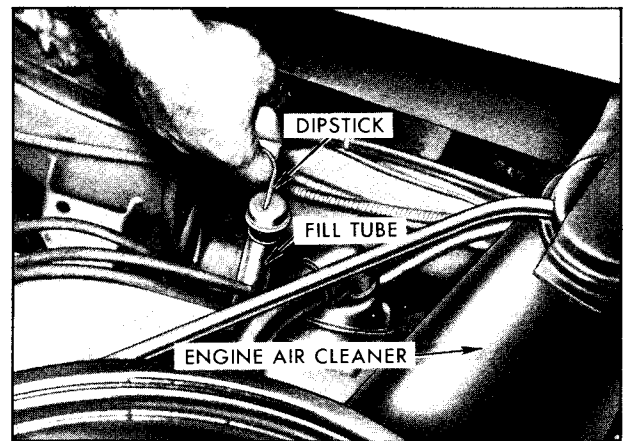

*Removing Transmission Dipstick*

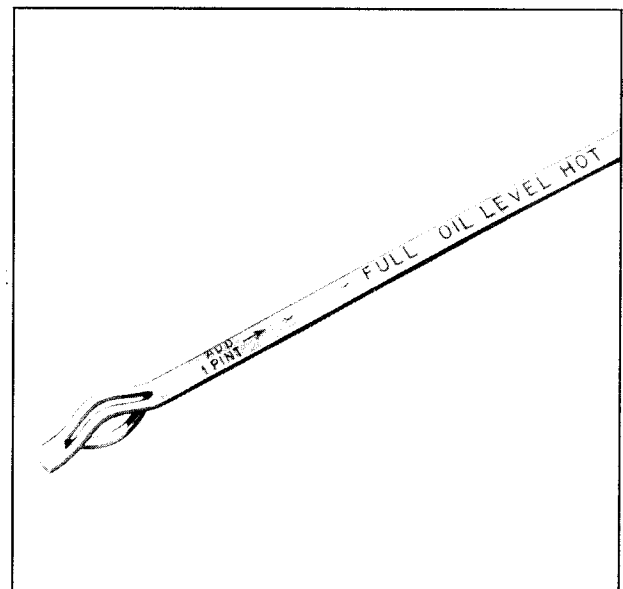

*Transmission Dipstick*

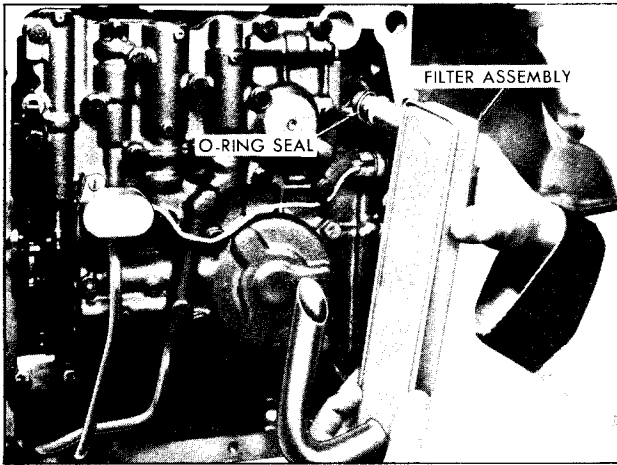

*Replacing Transmission Oil Filter*

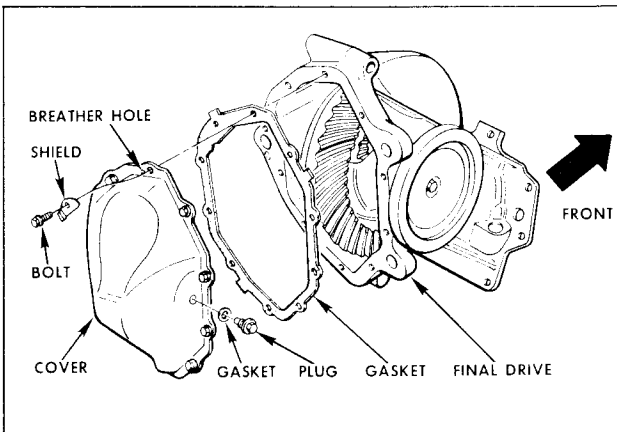

*Final Drive Cover Removal*

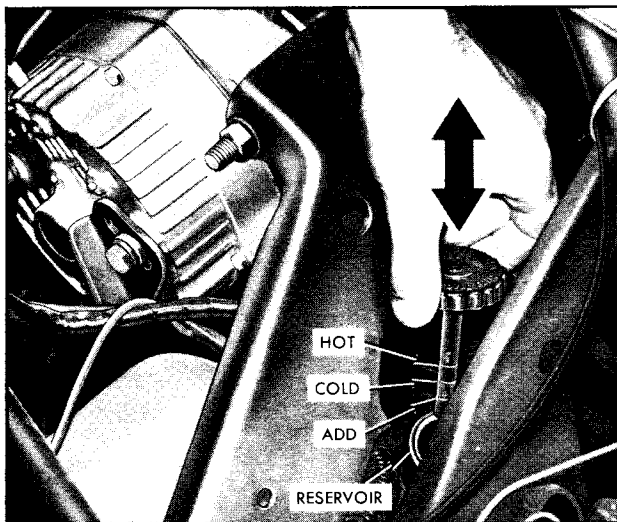

*Checking Power Steering Fluid Level*

6. Remove dipstick and wipe clean.
7. Reinsert dipstick until cap seats.
8. Remove dipstick and note reading.

If fluid level is at or below the "ADD" mark, add sufficient fluid to raise the level to the "FULL" mark. One pint raises the level from "ADD" to "FULL." Do not overfill. Refer to the Maintenance Chart for servicing schedule.

### TRANSMISSION OIL FILTER REPLACEMENT

**NOTE:** Have a drain pan ready as lubricant will begin to drain as bolts are loosened.

1. Remove (13) bottom pan attaching screws.
2. Remove bottom pan and discard gasket.
3. Remove and discard oil filter assembly.
4. Install new O-ring seal on new filter and intake pipe and filter assembly and install.
5. Using a new pan gasket, install pan. Torque attaching screws to 12 foot-pounds.

6. Add four (4) quarts of DEXRON® automatic transmission fluid and check fluid as noted above.

### FINAL DRIVE

#### FINAL DRIVE LUBRICANT REPLACEMENT

1. Remove (10) cover attaching bolts. Have a drain pan ready as lubricant will begin to drain as bolts are loosened.

2. Remove cover and allow lubricant to drain. Discard old gasket.

3. Using a new cover gasket, install cover. Torque attaching bolts to 24 foot-pounds. Shield to be bent over breather hole.

4. Add four pints of recommended lubricant through fill plug hole or fill until lubricant level is at the plug hole.

### STEERING SYSTEM

#### POWER STEERING SYSTEM

Check the fluid level in the power steering pump reservoir at each oil change period. This requires the removal of the engine access cover. The reservoir is located near the Delcotron. Add GM Power Steering Fluid (if GM Power Steering Fluid is not available, DEXRON® Automatic Transmission Fluid may be used) as necessary to bring level into proper range on the filler cap indicator depending on fluid temperature.

If at operating temperature (approx. 150° F. –hot to the touch) fluid should be between “HOT” and “COLD” marks. If at room temperature (approx. 70° F.) fluid should be between “ADD” and “COLD” marks. The fluid does not require periodic changing.

### STEERING LINKAGE

The steering linkage (tie rods) and suspension should be lubricated, using a water resistant E.P. Chassis Lubricant that meets GM Specification 6031-M, at every oil change. Seals should be checked for damage (see page 76).

## BRAKE SYSTEM

### BRAKE MASTER CYLINDER

The master cylinder is located behind the left-side access door on the front of the vehicle. The fluid level in the master cylinder should be checked at each oil change. Wipe off the brake cylinder filler cap and unsnap the retainer. A low fluid level in the front brake master cylinder reservoir could be an indicator that the disc brake pads need replacing. The fluid level must be maintained at ¼-inch below the top of each reservoir with Delco Supreme No. 11 or DOT-3 Brake Fluid or equivalent. When replacing the

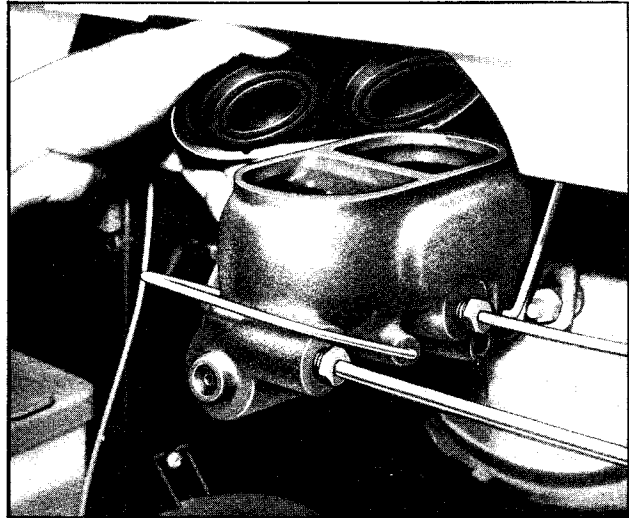

*Checking Brake Master Cylinder*

cap be sure to fasten the retainer securely, taking care not to let dirt enter the reservoirs.

### BLEEDING BRAKES

The need for bleeding brakes is generally indicated by springy, spongy pedal action. Pressure bleeding equipment must be used and a definite bleeding sequence and procedure must be followed. Consult your GMC Motor Home service outlet.

## SERVICING DETAILS

### ENGINE COOLING SYSTEM

The cooling system on GMC Motor Homes is of the closed-type and is designed to maintain the engine at proper operating temperatures. The coolant reservoir collects coolant that expands with rising temperature that would otherwise overflow from the system. When the system temperature drops, the coolant is drawn from the coolant reservoir back into the radiator by suction created by coolant contraction. It has been filled at the factory with a high-quality, inhibited, year-around coolant that meets the standards of General Motors Specification 1899-M. This coolant solution provides freezing protection to –20° F., and it has been formulated to be used for two full calendar years or 24,000 miles, whichever occurs first, of normal operation without draining, provided the proper concentration of coolant is maintained.

### CHECKING COOLANT LEVEL

- Open right engine access cover to check coolant level. Check the coolant level visually at

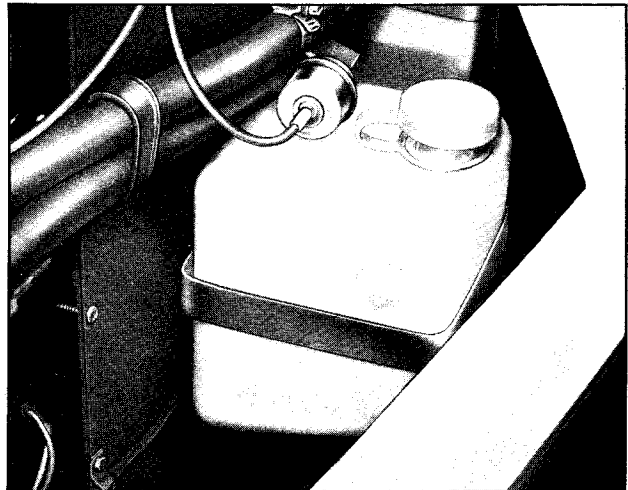

*Engine Coolant Reservoir*



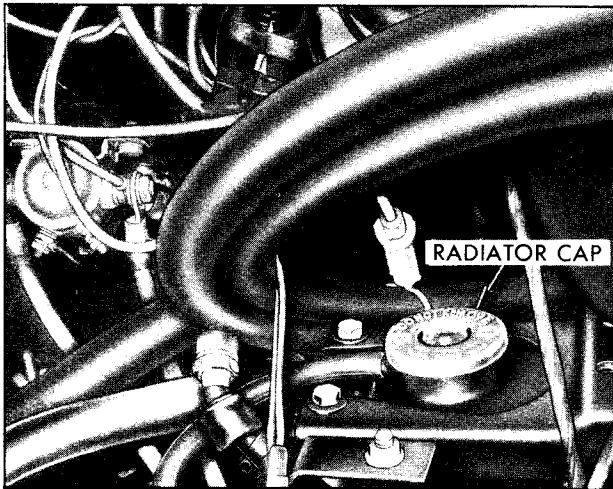

*Location of Radiator Cap*

the see-through coolant reservoir at each oil change interval while the engine is at normal operating temperature. **DO NOT REMOVE RADIATOR CAP EXCEPT FOR DRAINING AND REFILLING THE SYSTEM.** Coolant level should be between "COLD" and "HOT" marks on reservoir.

**NOTE:** It is normal for the level to be below "COLD" mark when the system cools and is below normal operating temperature.

- Add coolant to the reservoir only.
- Add a 50/50 mixture of high-quality ethylene glycol antifreeze and water if coolant additions are necessary. **DO NOT OVER-FILL.** If regular additions are required see your service outlet for a cooling system check.

**NOTE:** If recommended quality antifreeze is used, supplemental inhibitors or additives claiming to provide increased cooling capability are not necessary. They may be detrimental to the efficient operation of the system, and represent an unnecessary operating expense.

Every year, the cooling system should be serviced as outlined in the "Complete Vehicle Maintenance Schedule" page 67.

## **DRAINING AND REFILLING**

Following is a suggested procedure for draining and refilling the cooling system:

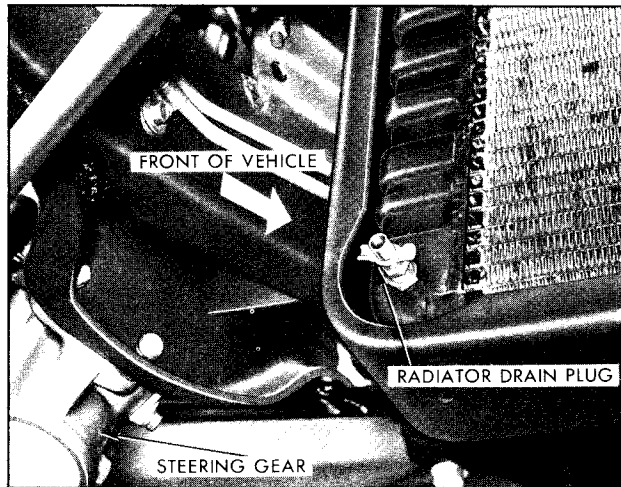

*Radiator Drain Plug*

### **CAUTION**

**To avoid the danger of being burned, and prevent loss of coolant, do not remove the radiator cap while the engine and radiator are still hot, because the cooling system will blow out scalding fluid and steam under pressure.**

1. Run engine, with radiator cap removed, until normal operating temperature is reached. On air conditioned models (automotive type), open water temperature control valve by moving the heater temperature control to maximum temperature position.
2. With engine stopped, drain radiator coolant by opening radiator drain valve located at the lower left-hand corner of the radiator.

### **CAUTION**

**If you siphon coolant from the radiator, DO NOT USE MOUTH to start siphoning action. The coolant solution is POISONOUS and can cause death or serious illness if swallowed.**

3. Close radiator drain valve, install block drain plugs, if removed, and add sufficient water to fill system.
4. Run engine, drain and refill the system, as described in Steps 1, 2, and 3, a sufficient number of times until the drained liquid is nearly colorless.
5. Allow system to drain completely and install block drain plugs, if removed.

6. Replace all old radiator and heater hoses with new hoses. Check and replace clamps as needed.

7. Remove and drain coolant reservoir. Flush reservoir with clean water and reinstall.

8. Fill radiator to filler neck with coolant meeting GM Specification 1899-M (for ease and speed of filling use a 20-inch length of rubber hose and funnel to add coolant at radiator cap), to provide the required freezing and corrosion protection (at least a 44 percent solution for  $-20^{\circ}$  F.) Install radiator cap. Make certain arrows on cap line up with overflow tube.

9. Fill reservoir to "COLD" level mark.

10. Add anti-foam GM-1050531 to vehicles equipped with automotive air conditioning. Run engine until normal operating temperature is reached.

11. Check and adjust coolant to proper level. Install coolant reservoir cap.

It is the owner's responsibility to keep the freeze protection at a level commensurate with the temperatures which may occur in the area of vehicle operation.

- Maintain cooling system freeze protection at  $-20^{\circ}$  F., or below to ensure protection against corrosion and loss of coolant from boiling, even though freezing temperatures are not expected.
- Add ethylene-glycol base coolant that meets GM Specification 1899-M when coolant additions are required because of coolant loss or to provide additional protection against freezing at temperatures lower than  $-20^{\circ}$  F.

**NOTE:** Alcohol or methanol base coolants or plain water are not recommended for your Motor Home at any time.

## THERMOSTAT

The cooling system is protected and controlled by a thermostat installed in the engine coolant outlet to maintain a satisfactory operating temperature of the engine. This thermostat is designed for continuous use through both winter and summer and need not be changed seasonally. When replacement is necessary, Delco parts are recommended.

## ENGINE FUEL SYSTEM

### FUEL REQUIREMENTS

Your Motor Home engine and optional motor generator are designed to operate on a good quality fuel of approximately 91 Research Octane Number or higher, commonly sold in the United States and Canada. Use of a fuel which is too low in anti-knock quality will result in "spark knock," a metallic rapping noise generated during the combustion process. It should be noted that Research Octane Number does not completely describe fuel octane quality. Therefore, if you hear a knock in your engine you may wish to try a different gasoline. If knocking persists consult your authorized Motor Home dealer. In any case, continuous or excessive knocking may result in engine damage and constitutes misuse of the engine for which GMC Truck & Coach Division is not responsible under the terms of the New Vehicle Warranty.

General Motors recommends the use of unleaded or low-lead (0 to 0.5 grams per gallon) gasolines to minimize emissions of hydrocarbons and particulates. If unleaded or low-lead gasolines are not available, gasoline containing more than 0.5 grams per gallon may be used.

In states using the Gasoline Performance and Information System of fuel designation, unleaded or low-lead fuels having an anti-knock designation of "2" or higher are recommended.

### FUEL SYSTEM

The Motor Home has two gasoline tanks of approximately 25 gallons each and a fuel switching device (see "FUEL SELECTOR" switch) which allows the driver to switch from the main

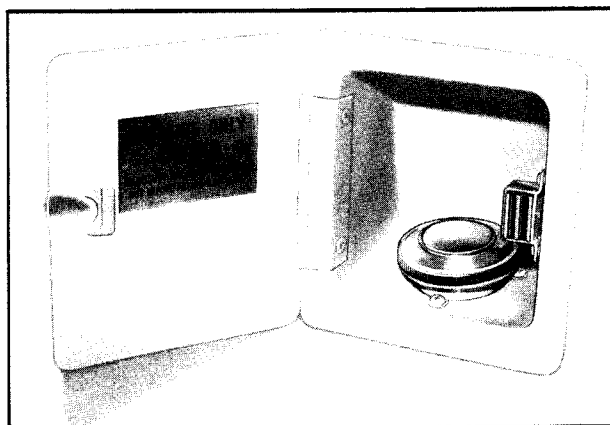

*Gasoline Fuel Filler Compartment*

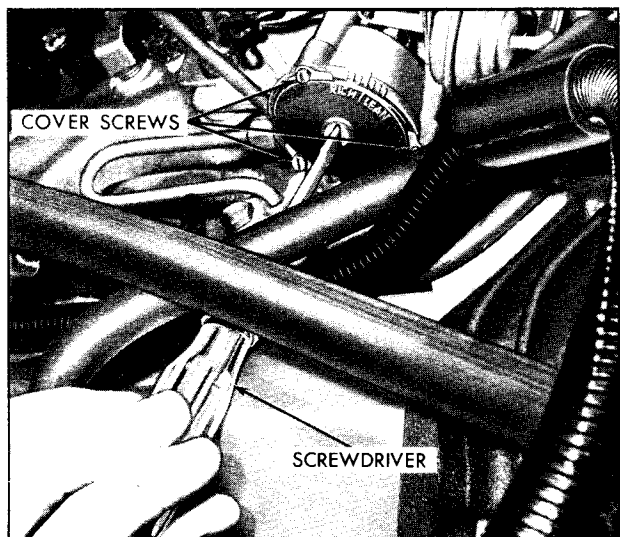

*Choke Coil Adjustment*

tank (when empty) to the auxiliary tank. The optional motor generator is fueled from the main fuel tank, but cannot totally deplete the vehicle's fuel.

The gasoline fuel filler compartment is located on the left side of the vehicle, directly under the driver's window.

#### CAUTION

It is important that all pilot lights be turned off and open flames kept away when filling the fuel system to help reduce fire hazard.

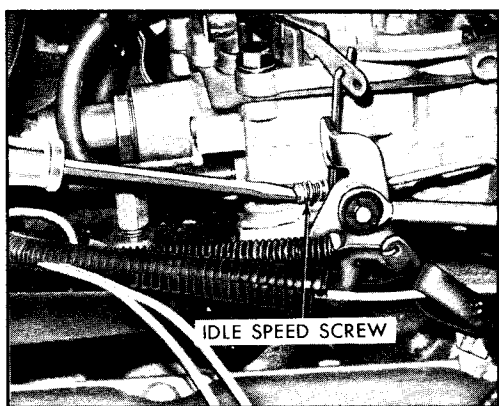

*Slow Idle Adjustment*

## CARBURETOR

To obtain maximum engine performance and fuel economy, carburetor idle speeds should be checked as recommended in the "Complete Vehicle Maintenance Schedule." If the engine stalls, idles too fast or slow, or idles roughly, the following adjustments should be performed. However, if the above symptoms persist it is recommended the Motor Home be taken to a GMC Motor Home service outlet.

### Choke Coil Adjustment

1. Hold choke valve wide open.
2. Loosen three cover attaching screws.
3. Using a standard screwdriver, rotate coil cover counterclockwise until pressure is felt at choke valve.
4. Continue rotating cover counterclockwise until cover mark is aligned with marks on choke housing.

**NOTE:** Using this procedure will ensure choke valve just closing at 75° F.

### Slow Idle Adjustment

1. Engine at normal operating temperature, remove air cleaner, disconnect air cleaner vacuum hose at intake manifold, then plug fitting.
2. Choke open and air conditioning off.
3. Put transmission in "PARK" position, set parking brake and block front wheels.
4. Disconnect carburetor hose from vapor canister and cover carburetor port with a piece of electrical or masking tape.
5. Disconnect distributor vacuum hose at distributor and plug.
6. With dwell and timing properly adjusted, adjust carburetor idle speed screw to obtain 600 RPM.

**NOTE:** Idle mixture has been preset at the factory and capped. **DO NOT REMOVE CAPS.**

7. Unplug distributor vacuum hose and reconnect to distributor. Remove tape from carburetor port and reconnect carburetor hose to vapor canister. Unplug vacuum fitting at intake manifold and reconnect air cleaner hose. Install air cleaner.

**NOTE:** Some engines will increase in idle speed during the break-in period. If this occurs, an idle speed adjustment should be made to obtain 600 RPM.

## Fast Idle Adjustment

1. Engine at normal operating temperature, remove air cleaner, disconnect air cleaner vacuum hose at intake manifold, then plug fitting.

2. Choke open and air conditioning off.

3. Put transmission in "PARK" position, set parking brake and block front wheels.

4. Disconnect carburetor hose from vapor canister and cover carburetor port with a piece of electrical or masking tape.

5. Disconnect distributor vacuum hose at distributor and plug.

6. With dwell and timing properly adjusted, place cam follower on low stop and against shoulder of next higher step. Adjust fast idle screw to obtain 1100 RPM.

7. Unplug distributor vacuum hose and reconnect to distributor. Remove tape from carburetor port and reconnect carburetor hose to vapor canister. Unplug vacuum fitting at intake manifold and reconnect air cleaner hose. Install air cleaner and recheck idle RPM.

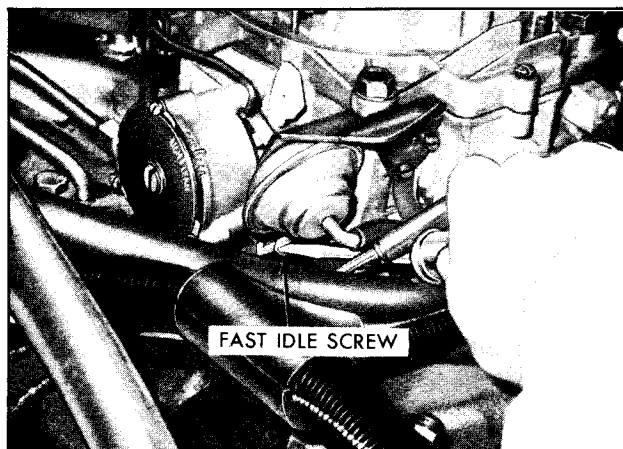

*Fast Idle Adjustment*

## Fuel Filter

To replace carburetor filter, disconnect fuel line, remove filter nut, gasket, filter, and spring. Install spring and element (open end of filter facing toward filter nut). Install gasket; tighten nut to 18 foot-pounds torque.

**IMPORTANT:** Tightening fuel inlet nut beyond specified torque can damage nylon gasket.

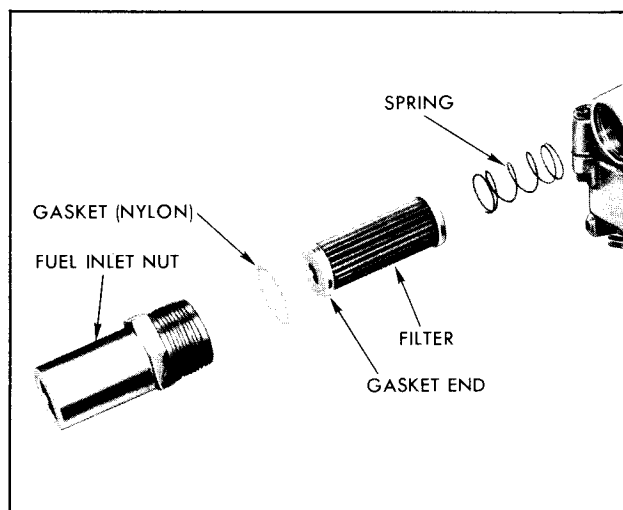

*Fuel Filter Components*

## ENGINE AIR CLEANER

The air cleaner is a disposable-type element. Replace the element as specified in the "Complete Vehicle Maintenance Schedule." Do not wash, oil, or clean with air hose. The air cleaner will require more frequent service under dusty conditions. Your GMC Motor Home service outlet can advise you on the proper interval. When replacement is necessary, an AC ACron air filter element is recommended.

### CAUTION

**DO NOT** remove the engine air cleaner unless temporary removal is necessary during repair or maintenance of the vehicle. When the air cleaner is removed, backfiring can cause fire in the engine compartment.

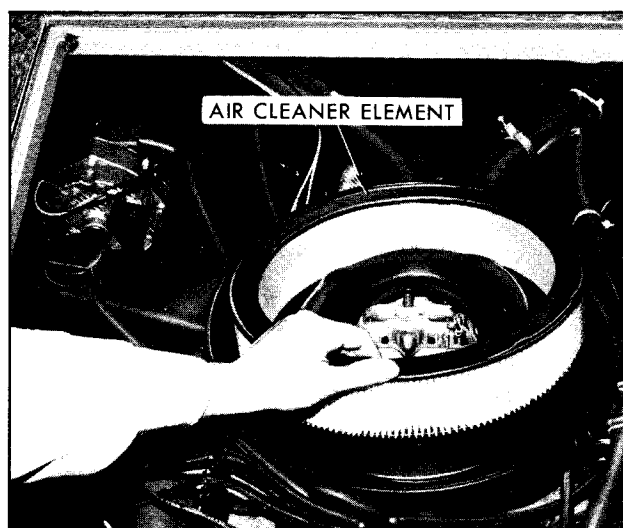

*Removing Engine Air Cleaner Element*

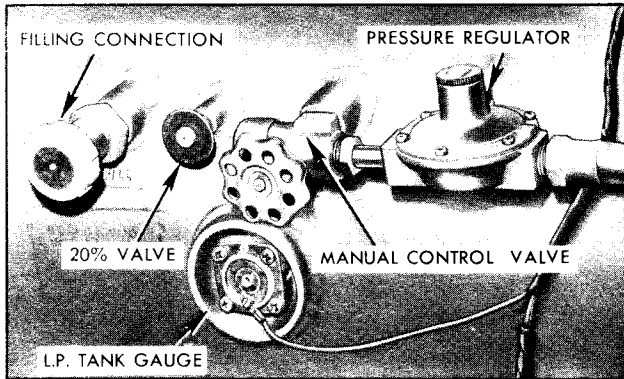

*LP Gas Tank Controls*

## LP GAS SYSTEM

### CAUTION

**If gasoline or LP gas fumes are noticed at any time, the cause should be determined and corrected without delay because of the possibility of fire.**

Bottled LPG (Liquid Petroleum Gas) is safe, economical, clean and conveniently available. It operates the kitchen stove and furnace in your Motor Home, as well as the gas/electric refrigerator, if so equipped.

The tank is located on the right side of the vehicle in a compartment behind the rear wheels. The tank is accessible only from outside of the vehicle.

The knob on the left is the filling connection. This is where the tank is filled. Next to it is the 20% valve, which is designed to prevent the tank from being overfilled. The control valve is next to it. This is where the main LP gas line to the vehicle can be shut off. On the line leading out of the control valve is the regulator valve. It should not be tampered with.

To fill the tank, drive the Motor Home to an LPG Dealer (**DO NOT REMOVE THE TANK**). The Dealer must use a P.O.L. adapter to fill the tank. The adapter is to be inserted into the filling connection. When liquid appears at the 20% valve the tank is full.

Always refill empty LP gas tank as soon as possible. Appliances will stop working when the gas supply becomes exhausted.

When you are not using the gas appliances, shut off the control valve on the tank; this will help prevent moisture from condensing inside the tank. Having a small amount of dry Methyl Alcohol put in the tank when you have it filled

will help prevent moisture in the tank and help prevent the lines from freezing in the winter.

You may find that in the southern part of the country only Butane is available for your LPG tank. It will work fine except that at temperatures below 30° F. Butane is in a liquid state. In this temperature range no vapor is produced to fuel the appliances. If you expect to encounter temperatures below 30° F., discharge the Butane from the tank and refill the tank with propane gas. Propane gas does not turn into a liquid until a temperature of -44° F.

When opening the valve to operate the system, open it all the way, then close it one-quarter turn. This will enable you to tell if the valve is open or closed.

### CAUTION

**BEFORE opening the control valve check that controls for all gas appliances are in the OFF position. If this is not done, LP gas could accumulate inside the vehicle creating a fire or explosion hazard.**

**DO NOT alter LPG tank in any way. The regulator on the tank is pre-set. DO NOT attempt to adjust it. This should be done by an authorized service outlet.**

**It is recommended that you travel with your LPG system off. All pilots and burners should be turned off and the control valve on the LPG tank should be off. This should also be done whenever the vehicle will not be in use. This reduces the hazard of leaking gas.**

## CHASSIS ELECTRICAL SYSTEM

### BATTERIES

There are two Delco Energizer Batteries used for the chassis and living area of the Motor Home. These are located behind the right front access door.

It is important that these batteries receive the following care:

1. The fluid level should be checked regularly utilizing the level indicator cap marked "DELCO EYE." If the transparent eye within the cap glows, fluid level is low.

2. Check the fluid level in each cell at each engine oil change interval and more often in hot weather. (To do this it may be helpful to use a small hand mirror.) Add only colorless, odorless drinking water or distilled water to bring the level to the split-ring in the filler opening. **DO NOT OVERFILL.**

3. Keep your batteries, battery cable terminals, and battery hold-down brackets clean. They should be cleaned every 12,000 miles or once a year. Use a brush and a solution of ammonia and water or baking soda and water. Flush off with clear water. After cleaning apply petroleum jelly or petrolatum to battery cable terminals to help retard corrosion.

4. If battery performance becomes questionable, see your service outlet.

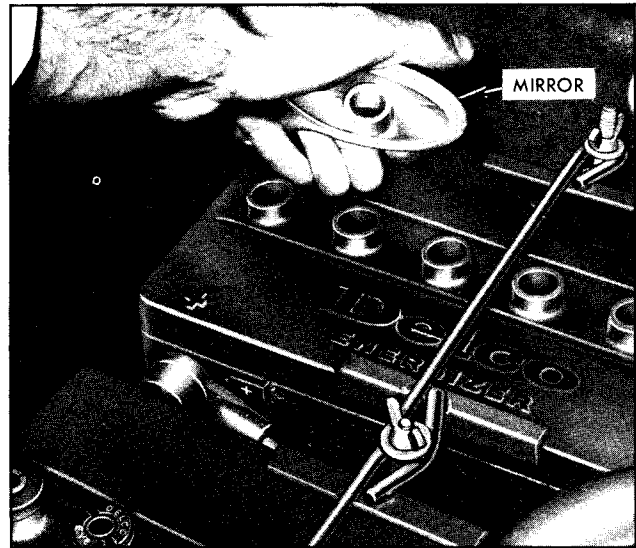

*Checking Batteries*

### CAUTION

**Never expose battery to open flame or electric spark—battery action generates hydrogen gas which is flammable and explosive. Don't allow battery fluid to contact skin, eyes, fabrics, or painted surfaces—fluid is a sulfuric acid solution which could cause serious personal injury or property damage. Wear eye protection when working with battery. Remove rings, metal watchbands and other metal jewelry before jump starting or working around a battery, and be careful in using metal tools—if such metal should contact the positive battery terminal (or metal in contact with it) and any other metal on the vehicle, a short circuit may occur which could cause personal injury.**

For "Battery Jump Starting Procedure" see **IN CASE OF EMERGENCY** section.

### DELCO TRON GENERATOR

The Delcotron produces an AC (alternating current) which is converted to DC (direct current) through diodes. There is a continuous flow of direct current, even at engine-idle speed. This permits the Delcotron to charge the batteries at engine idle. And this, in turn, keeps the battery more fully charged at all times for more dependable starts and longer battery life. Periodic service is not required.

### GENERATING SYSTEM PRECAUTIONS

Observe the following "DO NOT's" when performing any service operations on the electrical system:

- **DO NOT** short across or ground any terminals of the generator or regulator.
- **DO NOT** attempt to polarize the generator.
- **DO NOT** reverse positive (+) or negative (—) leads on generator or battery.
- **DO NOT** operate generator on open circuit.
- **DO NOT** reverse positive (+) or negative (—) leads when connecting booster battery or battery charger. The positive (+) charger lead must connect to the positive terminal junction block, marked "VEHICLE BATTERY POSITIVE." Connect negative (—) lead to the right radiator mounting bracket.
- For battery jump starting procedure and cautions refer to the section **IN CASE OF EMERGENCY**.

**IMPORTANT:** If necessary to disconnect battery, disconnect negative (—) cable first and when connecting cables, install positive (+) cable first.

Whenever difficulty with the electrical system is indicated, it is the owner's responsibility to check and correct the following:

- Check Delcotron drive belt tension and adjust if necessary.
- Check battery, regulator, and generator for good ground.
- Clean and tighten cable connections at battery posts.
- Inspect wiring for frayed insulation and for broken or loose connections.
- Test battery and recharge if necessary.

When an over- or under-charged battery condition exists which cannot be corrected by the above suggestions, the complete generating system should be checked by a qualified service technician.

**NOTE:** These vehicles cannot be started by pushing.

## DISTRIBUTOR

Distributor maintenance, which is the owner's responsibility, includes regular examination of the distributor cap for cracks, checking condition of ignition wires, maintaining serviceable distributor points, and proper ignition timing at specified intervals. Refer to the "Complete Vehicle Maintenance Schedule" for additional information.

### Distributor Point Replacement

Remove the distributor cap and shields, remove the contact set attaching screws and then

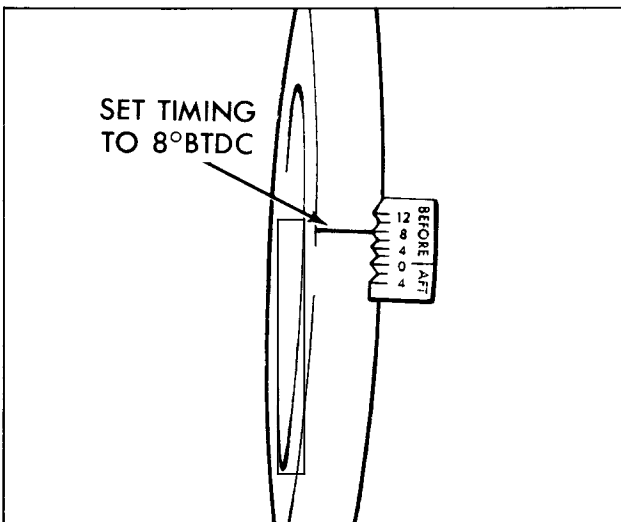

*Engine Ignition Timing*

pull the wires up out of the quick disconnect terminal. When installing new point set, pilot on contact set must engage matching hole in breaker plate. Also make sure that flat side of wire terminals are inserted back-to-back in the quick disconnect terminal. Install point set attaching screws.

### Distributor Point Adjustment

Distributor points can be adjusted through the window in distributor cap, using a special tool or an Allen wrench. Adjust points with engine idling by turning adjusting screw clockwise until engine begins to misfire, then back out one-half turn.

**IMPORTANT:** When new points are installed on any engine, a flat feeler gauge can be used to check point opening. Correct point opening is 0.019" for new points, or 0.016" for used points. A tach-dwell meter should be used to check points. Adjust dwell angle to 30°.

## ENGINE CYLINDER IDENTIFICATION AND FIRING ORDER

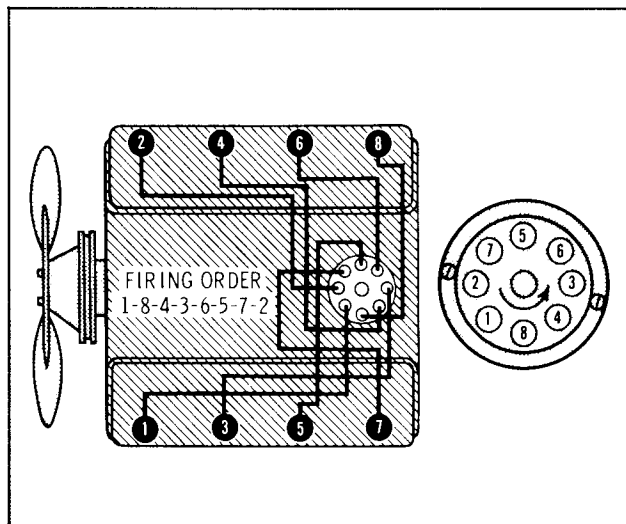

### IGNITION TIMING

The ignition timing marks are located on the engine front cover. A slot on the balancer indicates engine Top-Dead-Center (TDC).

To adjust ignition timing, proceed as follows:

1. Disconnect vacuum hose at distributor and plug hose. If air cleaner is removed, it will also be necessary to plug vacuum hose fitting with tape.

2. Connect tachometer and adjust engine speed to 1100 RPM.

3. With the use of a timing light, set timing to 8° BTDC by loosening the distributor clamp bolt and rotating the distributor until the specification is obtained.

**NOTE:** The indicator has four "V" slots; each slot represents 4 degrees.

4. Tighten the distributor clamp bolt and recheck timing to make sure distributor was not moved during tightening of bolt.

**NOTE:** If a tuned engine detonates with this setting, the cause is low octane fuel or excessive carbon build-up in the combustion chamber. If these factors are not corrected, the timing should be retarded 2 degrees.

5. Remove plug from distributor vacuum hose and connect hose. If air cleaner was removed, remove tape from manifold fitting and connect vacuum hose, install air cleaner.

## SPARK PLUGS

The frequency of spark plug service intervals is explained in the "Complete Vehicle Maintenance Schedule." Servicing is the owner's responsibility. Before removing plugs, clean plug wells thoroughly, clean the threads and seats in the cylinder heads to assure proper seating and heat transfer. Always use new plug gaskets and tighten plugs to 35 foot-pounds torque. A special socket is available to prevent damaging the spark plug porcelain.

### Spark Plug Gap Adjustment

1. Clean exterior of plugs and inspect for cracked insulators, poor sealing gaskets or excessively burned electrodes.

2. Clean all serviceable plugs with an abrasive type cleaner. File center electrode flat. (Do not file center electrode on new plugs.)

3. Adjust spark plug gap to .040" using a round feeler gauge.

4. Install plugs and torque to 35 foot-pounds.

## HEADLIGHTS

Make a headlight beam adjustment check a regular part of your "Safety Maintenance" program. Sealed-Beam units are No. 6014 which

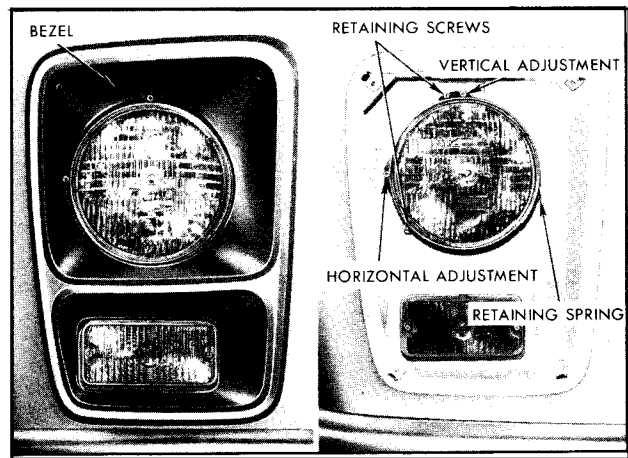

*Headlight Replacement*

are equipped with ground guide points for the use of a mechanical aiming device. Your authorized service outlet is best qualified to adjust your headlights.

### Headlight Beam Adjustment

**NOTE:** Cutouts in headlight bezel permit access to adjustment screws.

Headlights should be adjusted properly. The top adjusting screw provides vertical adjustment and the side adjusting screw provides horizontal adjustment. Headlights should not have to be adjusted after replacing Sealed-Beam unit, providing headlights were in proper adjustment before replacement and adjusting screws were not disturbed during replacement.

### Headlight Replacement

To replace a Sealed-Beam unit, remove bezel. Then disengage the tension spring using a stiff hooked tool. Rotate the Sealed-Beam assembly slightly to disengage mounting ring slots from groove of each adjusting screw, then pull forward. Disconnect wiring at the base of unit and separate the Sealed-Beam assembly by removing the two retaining screws. Install Sealed-Beam unit in reverse order of removal.

## EXTERIOR LIGHTS

All exterior lights can be easily replaced by removing lens, pushing bulb in slightly and turning counterclockwise, except side marker lights which are simply pressed in. Then, with new bulb, reverse procedure.



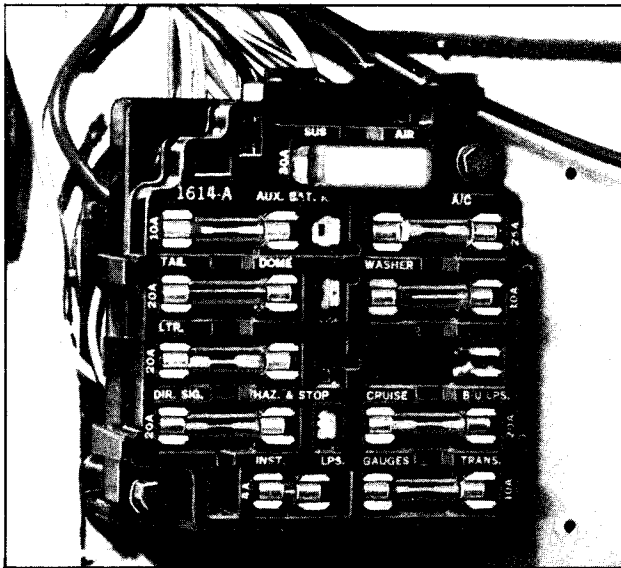

*Chassis Fuse Block*

### CHASSIS FUSES, FUSIBLE LINKS, CIRCUIT BREAKERS

The wiring circuits in your Motor Home are designed to be protected from short circuits by a combination of fuses, circuit breakers, and fusible thermal links in the wiring itself. This helps to reduce the hazard of electrically-caused fires in the vehicle.

The fuse and circuit breaker block is located behind the glove compartment door. All chassis circuits are protected by fuses or circuit breakers located here except:

- **HEATER BLOWER**—Which has a 30-amp in-line fuse located behind the right access door near the heater blower motor.
- **HEADLAMP CIRCUITS**—Are protected by a circuit breaker in the main light switch. An electrical overload in the light circuit will cause the lights to go on and off or in some cases to remain off. If this condition develops, have the wiring circuits checked immediately.

Circuit breakers of remote reset type can be reset only after turning the affected circuit control switch "OFF" for approximately 40 seconds, or by removing the breaker from clips for this period of time.

### CAUTION

**Do not touch body of any installed breaker of this type with bare hands; if circuit should happen to be shorted or overloaded—the breaker body could be hot and cause a burn.**

A replaceable fuse link is located at the battery pickup junction block behind the right access door. If an overload should occur, this link is designed to fail (open circuit) preventing damage to the main wiring harness. Another link of the same wire gauge and length must be installed in its place in the event of failures.

**IMPORTANT:** When replacing fuse or circuit breaker, make sure replacement is of same number as marked on block.

### TURN SIGNAL AND HAZARD WARNING FLASHER

The turn signals and the hazard warning system both operate with the same flasher. This flasher is clipped behind the dashboard just to the right of the steering column.

### LIVING AREA ELECTRICAL SYSTEM

Both the 12-volt DC and 120-volt AC circuits in the Motor Home living area are designed to be protected by a series of fuses and circuit breakers. The 12-volt living area circuits are protected by automotive-type fuses, and the 120-volt circuits are protected by circuit breakers like those found in modern homes.

The 12-volt living area fuse block is located in the electrical compartment, next to the hall closet, along with power converter and main

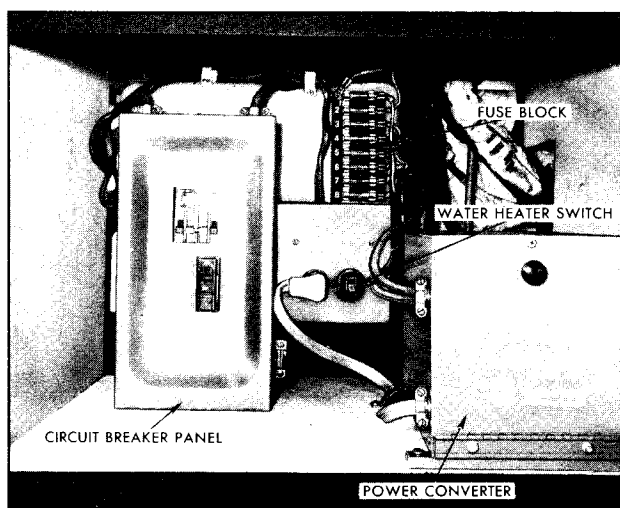

*Living Area Electrical Compartment*

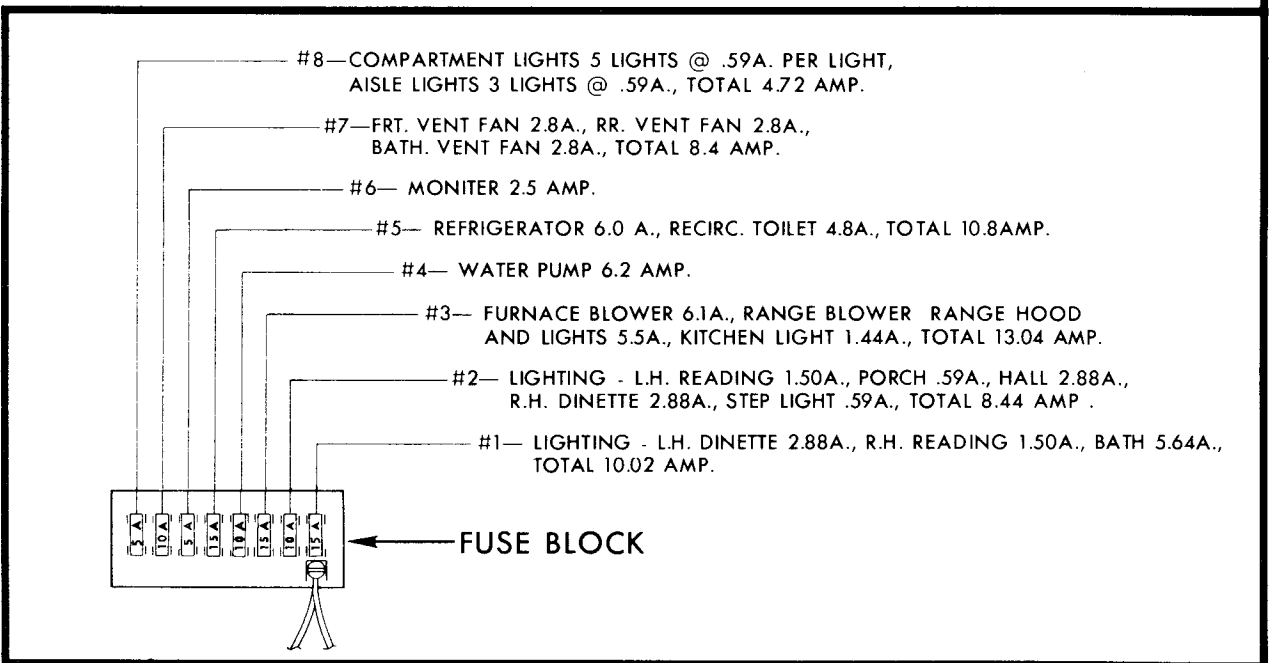
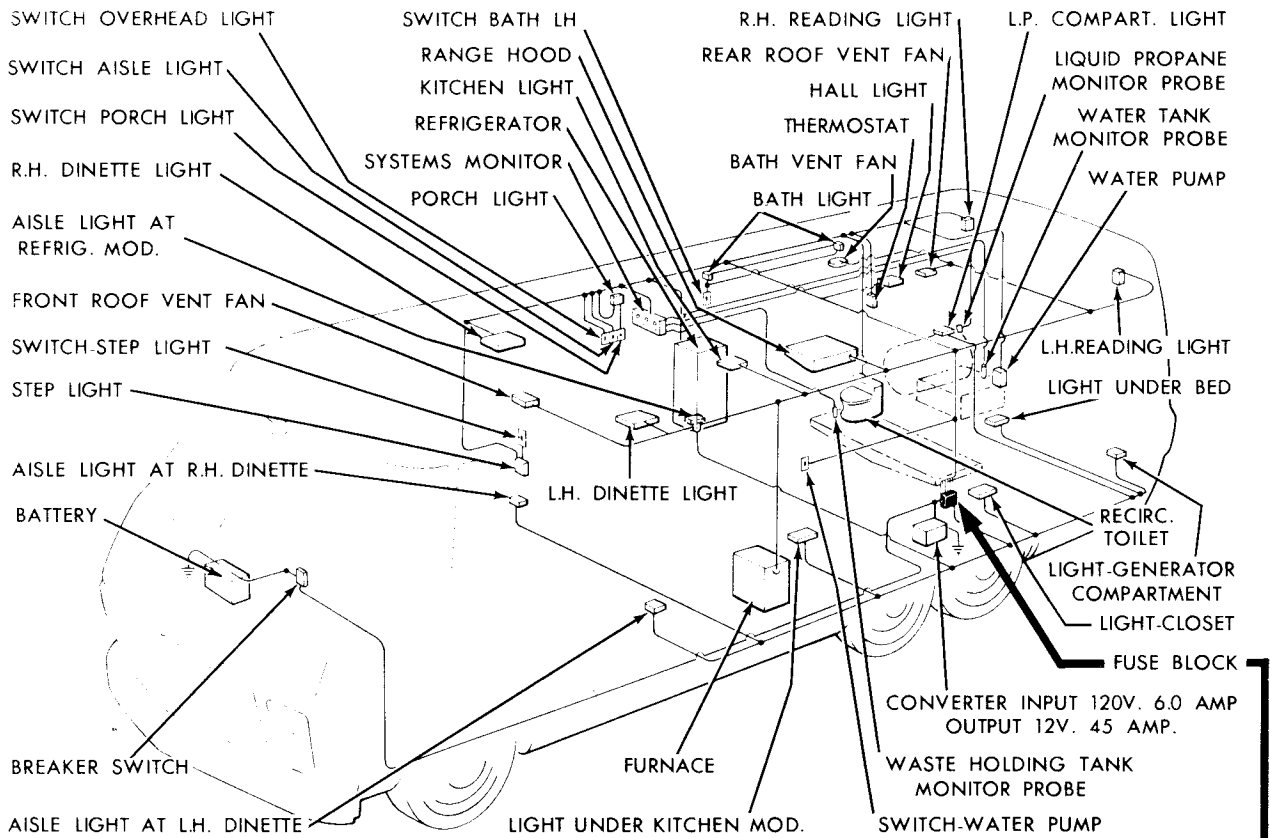

*Living Area 12-Volt DC Electrical System (Typical)*

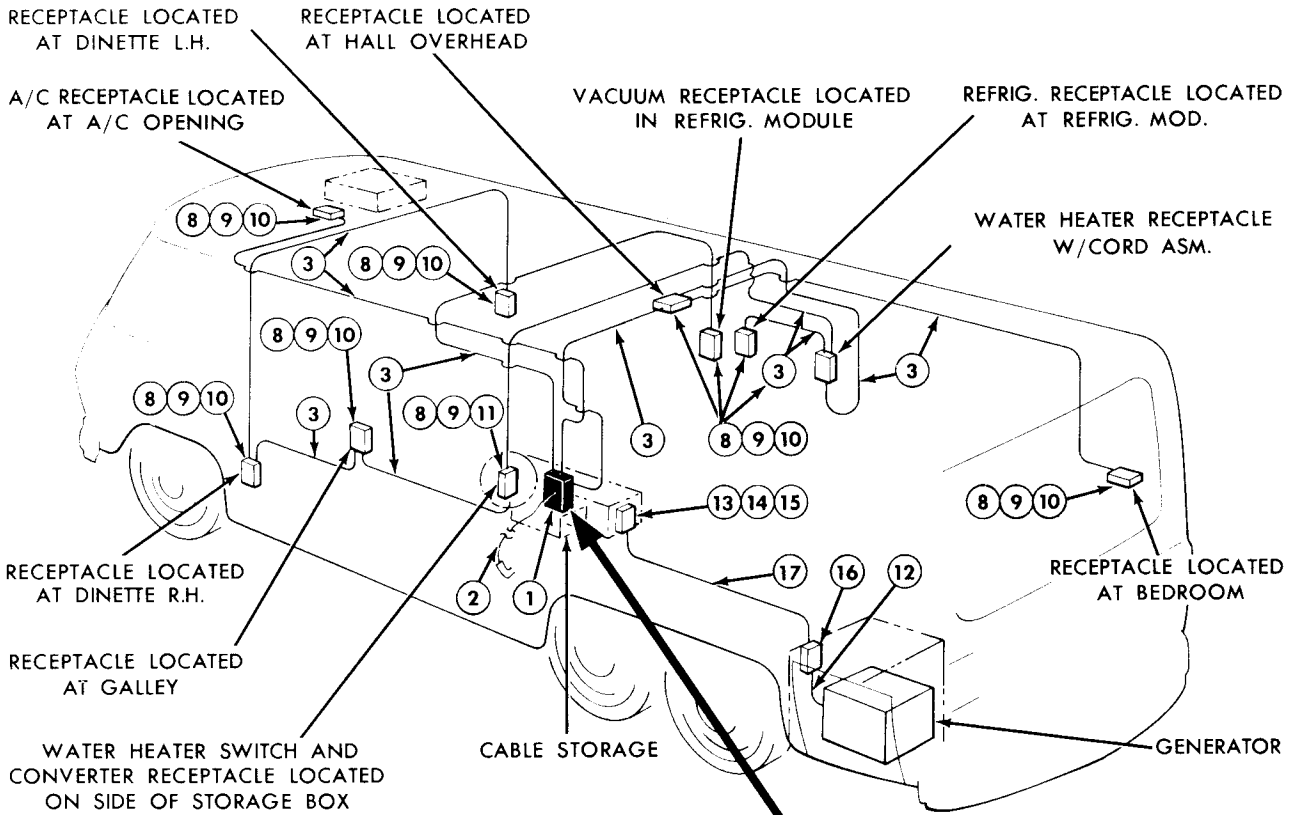

ITEM NO.	PART NAME
1	CIRCUIT BREAKER PANEL
2	#8-4 WIRE CORD TYPE "SO" W/PLUG
3	WIRE 12/2 W/GROUND WIRE
4	40 AMP BREAKER
5	20 AMP BREAKER
6	CABLE CONNECTOR
7	#8 COPPER GROUND WIRE
8	OUTLET BOX
9	DUPLEX RECEPTACLE
10	OUTLET PLATE
11	SWITCH & RECEPTACLE
12	#8-4 WIRE CORD TYPE "SO"
13	3 POLE 4 WIRE RECEPTACLE
14	OUTLET BOX
15	OUTLET PLATE
16	"J" BOX
17	#8-4 WIRE CORD ROMEX

CIRCUIT BREAKER PANEL			
CIRCUIT #1	CIRCUIT #2	CIRCUIT #3	CIRCUIT #4
CONVERTER RECEPT.	HALL OVER RECEPT.	AIR COND. RECEPT.	VACUUM RECEPT.
GALLY RECEPT.	BEDROOM RECEPT.		
L.H. DINETTE RECEPT.	BATH & WATER HEAT. RECEPT.		
R.H. DINETTE RECEPT.			

120-Volt AC Electrical System (Typical)

circuit breaker panel. In the event of an overloaded circuit, the cause should be corrected and a new fuse of the same capacity installed. For explanation of 12-volt fuse block number code, refer to **GENERAL DATA AND SPECIFICATIONS** later in this manual.

The main circuit breaker panel, also located in the living area electrical compartment, contains circuit breakers that are designed to snap to the "OFF" position in the event of an overloaded 120-volt circuit. Once the cause of the overload is corrected the circuit breaker switch may be moved back to the "ON" position.

The 120-volt/12-volt power converter, located in the living area electrical compartment, requires no periodic maintenance but care must be taken to ensure a proper flow of air through and around the unit. Do not set objects close to or on top of it. Do not let the power converter get wet and keep it as clean as possible to help assure long life. The unit could be cleaned with air pressure (30 psi max.) if necessary.

## ONAN MOTOR GENERATOR MAINTENANCE

### SERVICE INTERVALS

For service intervals refer to the Maintenance Chart provided earlier in this section on page 73.

### CHECKING OIL LEVEL

Check the oil level daily, or at least every eight hours of operating time. Check more often on a new unit as oil consumption is generally higher until piston rings seat properly.

### CHANGING OIL

Initial oil change should be made after the first 25 hours of operation; change every 50 to 100 hours after that. If operating in extremely dusty or cold weather conditions, change oil more frequently.

The 4KW Model has an oil capacity of 3 quarts, 3½ quarts if replacing oil filter.

The 6KW Model has an oil capacity of 4 quarts; 4½ quarts if replacing oil filter.

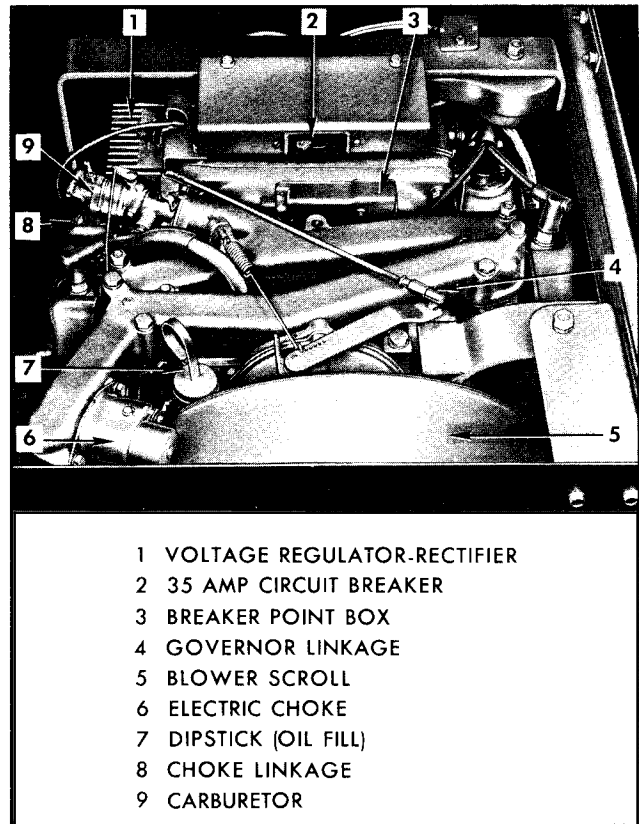

*Onan Motor Generator (Top View)*

Do not mix brands or grades of motor oil. Use a good quality oil with the designation SE/CC. If necessary to add oil between changes, use the same brand and grade of oil.

Use the following chart as a guide for the proper oil according to temperature ranges:

TEMPERATURE	RECOMMENDED OIL
Above 30°F.	SAE 30
0°F. to 30°F.	SAE 5W30 or 10W40
Below 0°F.	SAE 5W30

**NOTE:** Fill engine with oil through dipstick tube.

The oil drain plug is located on the bottom side of the engine oil base. Unit must be pulled out on its slide rail to gain access.

### OIL FILTER

Change the crankcase oil filter at least every 200 hours on the 4KW Model and every 100

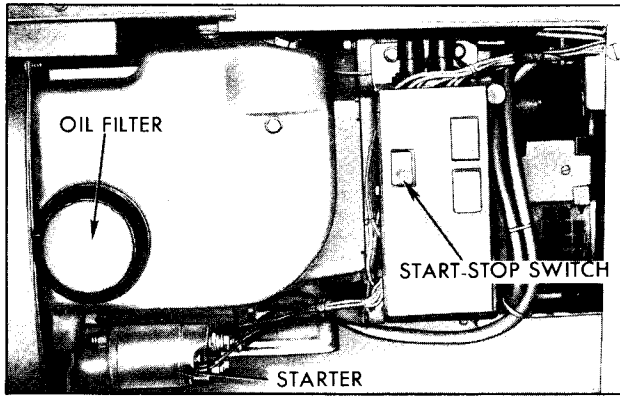

*Onan Motor Generator (Right-side View)*

hours on the 6KW Model. The filter is located on the right side of the unit (facing the compartment). Remove by turning counterclockwise with a filter wrench. Before installing new filter, coat the gasket on the filter's base with a light film of new oil. Install by turning clockwise until a light friction is noted, then turn an additional  $\frac{1}{4}$  to  $\frac{1}{2}$  turn.

**CAUTION**

**Do not over-tighten filter as damage may occur to rubber gasket which will cause filter to leak. Be sure to install sealing ring around filter; this ring is an air seal to prevent cooling air loss.**

**FUEL PUMP FILTER ELEMENT**

Every 100 hours or sooner on the 4KW Model, or every 500 hours on the 6KW Model drain the fuel pump and check filter element. Remove fuel pump mounting screws and turn off hex nut on base of pump. If element appears dirty, replace with a new one. Be sure to replace gaskets when reassembling.

**CARBURETOR BOWL**

Remove carburetor bowl from carburetor every 400 hours on the 4KW Model and every 500 hours on the 6KW Model, and clean the screen in solvent. Blow out with low pressure compressed air and reassemble, making sure gaskets are in place.

**GOVERNOR**

The governor controls the speed of the unit by opening or closing the throttle according to the load placed on the motor generator. Every 50 hours on the 4KW Model and every 200 hours on the 6KW Model, check governor linkage for freedom of movement through its entire travel. Clean and lubricate ball joint with graphite grease.

**BATTERY**

If any cell is low on water, add colorless, odorless, drinking water and recharge.

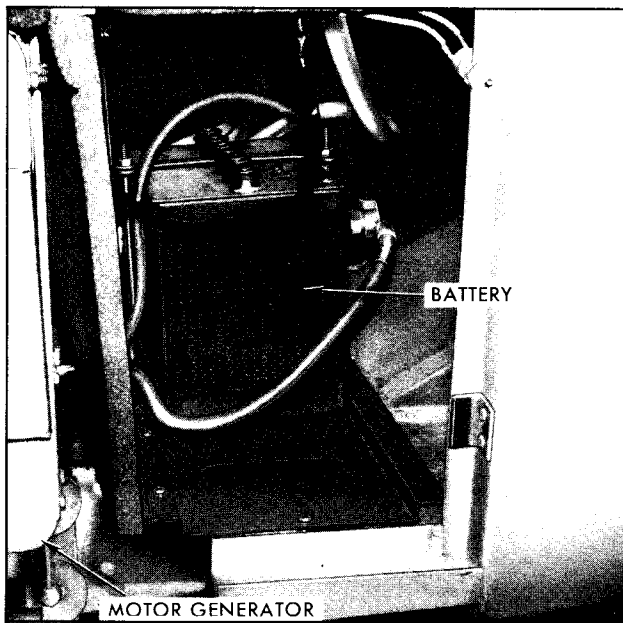

*Motor Generator Battery (Model 260)*

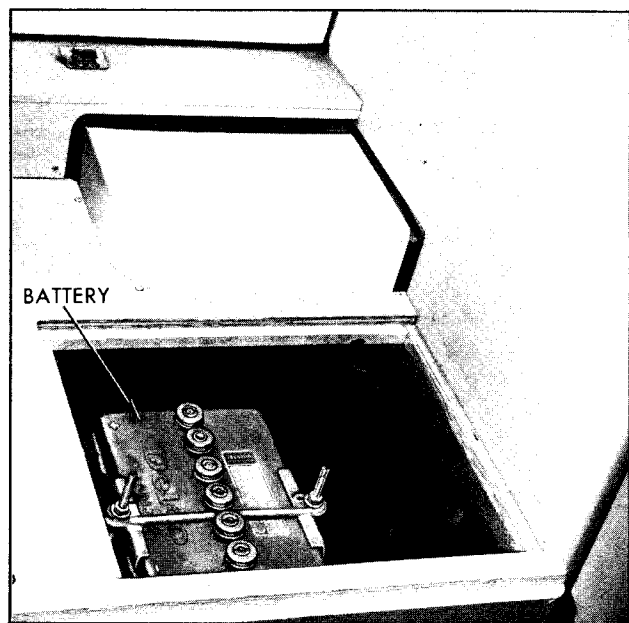

*Motor Generator Battery (Model 230)*

Keep the battery clean and dry. An accumulation of moisture will lead to a more rapid discharge and battery failure.

Keep the battery terminals clean and tight. Coat the terminals with a light application of petroleum jelly or grease to retard corrosion (See additional information pages 84-86).

### CAUTION

Never expose battery to open flame or electric spark—battery action generates hydrogen gas which is flammable and explosive. Don't allow battery fluid to contact skin, eyes, fabrics, or painted surfaces—fluid is a sulfuric acid solution which could cause serious personal injury or property damage. Wear eye protection when working with battery. Remove rings, metal watchbands and other metal jewelry before jump starting or working around a battery, and be careful in using metal tools — if such metal should contact the positive battery terminal (or metal in contact with it) and any other metal on the vehicle, a short circuit may occur which could cause personal injury.

### SPARK PLUGS

Check, clean and reset spark plugs every 100 operational hours. Replace spark plugs that show signs of fouling or electrode erosion. It is recommended that spark plugs be replaced at the beginning of each new season.

### COOLING SYSTEM

The motor-generator is cooled by a flywheel blower fan which pulls air over the cylinders and cooling fins. The air path is directed by sheet metal shrouds and plates. These shrouds and plates must always be installed properly so unit does not overheat.

Check and clean (if necessary) the cooling fins every 50 hours of operation. Remove any dust, dirt or oil which may have accumulated. Check compartment air inlet and air outlet for build-up of dirt, etc.

### AIR CLEANER

Check and clean the air cleaner element at least every 100 operational hours. Loosen wing nut to remove. Clean by tapping base lightly on

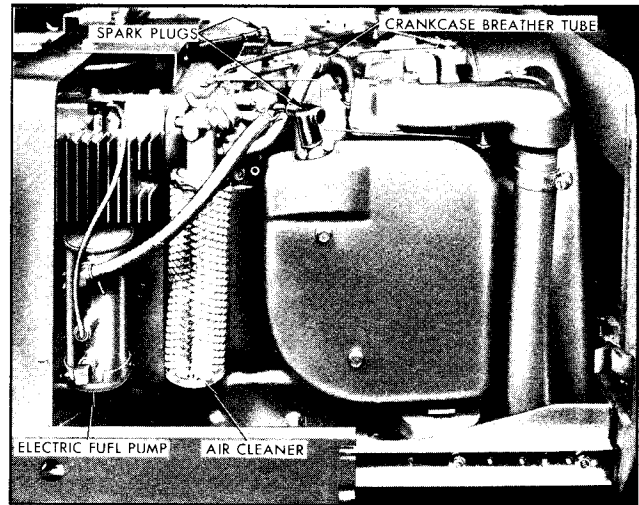

*Onan Motor Generator (Left-Side View)*

a flat surface. Replace element at least every 200 hours on the 4KW Model and every 500 hours on the 6KW Model. Clean or replace more often in dusty conditions.

### CAUTION

Do not remove the air cleaner unless temporary removal is necessary during repair or maintenance. When the air cleaner is removed backfiring can cause fire in the generator compartment.

### BREAKER POINTS

To maintain maximum efficiency from the unit, change the breaker points every 200 hours of operation. To change the breaker points use the following procedure:

1. Remove the two screws and the cover on the breaker box.

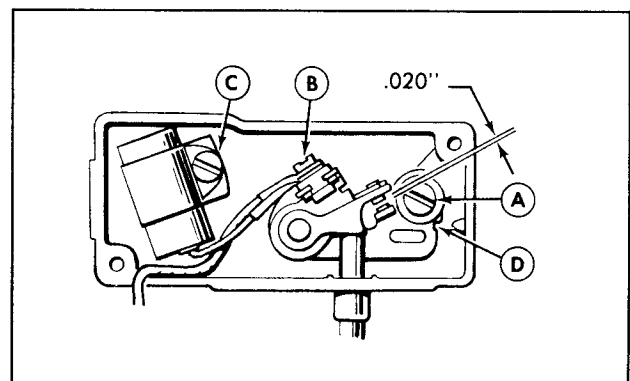

*Onan Breaker Point Adjustment*

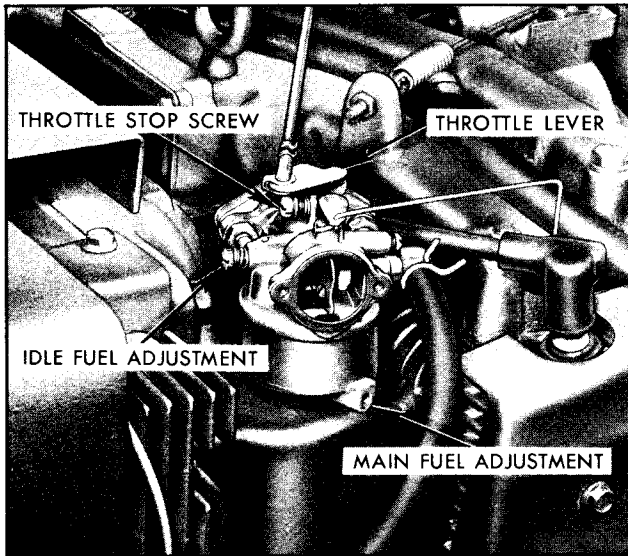

### *Onan Motor Generator Carburetor Adjustment Points*

2. Remove the two spark plugs so the engine can easily be rotated by hand. Check condition of spark plugs at this time.
3. Remove mounting screw (A) and pull the points out of the box just far enough so screw (B) can be removed and leads disconnected.
4. Remove screw (C) and replace condenser with a new one.
5. Replace points with a new set but do not completely tighten mounting screw (A).
6. Remove the access hole cover on the top of the blower housing. This provides an access to view timing mark.
7. Rotate the engine clockwise (facing flywheel) by hand until the 21° BTDC mark on gear cover aligns with mark on flywheel on the 4KW Model. On the 6KW Model, rotate it to the 25° BTDC mark. Turn another ¼ turn (90°) to ensure points are fully open.
8. Using a screwdriver inserted in notch (D) on the right side of points, turn points until gap measures .020" with a flat thickness gauge (be sure feeler is clean). Tighten mounting screw (A) and recheck gap.

### **CARBURETOR**

The carburetor has a main fuel (power) adjustment and an idle fuel adjustment. The main

adjustment affects operation under heavy load conditions. Idle adjustment affects operation under light or no-load conditions. Under normal circumstances, factory carburetor adjustments should not be disturbed.

On the 6KW Model the normal settings are 1 5/8-turn open for main fuel adjustment and one turn open for idle fuel adjustment.

**IMPORTANT:** Forcing the needle against its seat will damage it. The needle does not completely shut off fuel when turned fully in.

Before final adjustment, allow the engine to warm up. Make the idle adjustment under no load. Open the main fuel adjustment until the engine runs smooth under acceleration with no load. Slightly more fuel may be needed (open about ¼-turn further) when sudden load is applied or if operating in very cold weather. Set the throttle stop screw with no load connected and while running at a low speed setting. Turn the screw to give approximately 1/32-inch between the throttle stop screw and throttle lever.

On the 4KW Model the normal setting is to turn the idle fuel adjustment and the main fuel adjustment off their seats 1 to 1 ½ turns to permit starting. Then, readjust them for smooth operation. Set the throttle stop screw with no load connected to unit. Turn throttle lever so it just touches throttle stop screw, then turn throttle stop screw (with throttle level still touching it) until unit is running at 1500 RPM. Before final adjustment, allow the engine to warm up. Make the idle adjustment under no load. Open the main fuel adjustment until the engine runs smooth under acceleration with no load. Slightly more fuel may be needed (open about ¼ turn further) when sudden load is applied, or if operating in very cold weather.

If the engine develops a "hunting" condition (alternate increase and decrease of engine speed), try correcting by opening the main fuel adjustment a little more. Do not open more than ½ turn beyond the maximum power point.

# KOHLER MOTOR GENERATOR MAINTENANCE

## SERVICE INTERVALS

For service intervals refer to the Maintenance Chart earlier in this section on page 73.

## CRANKCASE OIL

The oil level should be checked every time the unit is operated. The unit must not be operated if the oil level is above the "F" mark, or below the "L" mark on the dipstick. The oil level should not be checked when the unit is running as oil may splash from the dipstick opening.

Use a good quality detergent oil that meets the A.P.I. (American Petroleum Institute) Service Designation SE/CC. Use the proper SAE oil for expected temperature conditions.

TEMPERATURE	RECOMMENDED OIL
Above 30°F.	SAE 30
0°F. to 30°F.	SAE 10W-30
Below 0°F.	SAE 5W-20

**NOTE:** Fill engine through dipstick tube.

**IMPORTANT:** The initial oil change should be at the end of 5 operational hours.

The oil change interval is every 50 operational hours, or every 6 months, whichever comes first. If possible, change the oil while it is hot. The crankcase capacity is 3 quarts.

## AIR CLEANER

Engine is equipped with a dry-type air cleaner. After first 50 operational hours, remove element and service by tapping lightly against a flat surface to dislodge loose surface dirt. Do not clean in any liquid or blow out with compressed air as this will damage filter material. Replace the filter element every 100 operational hours.

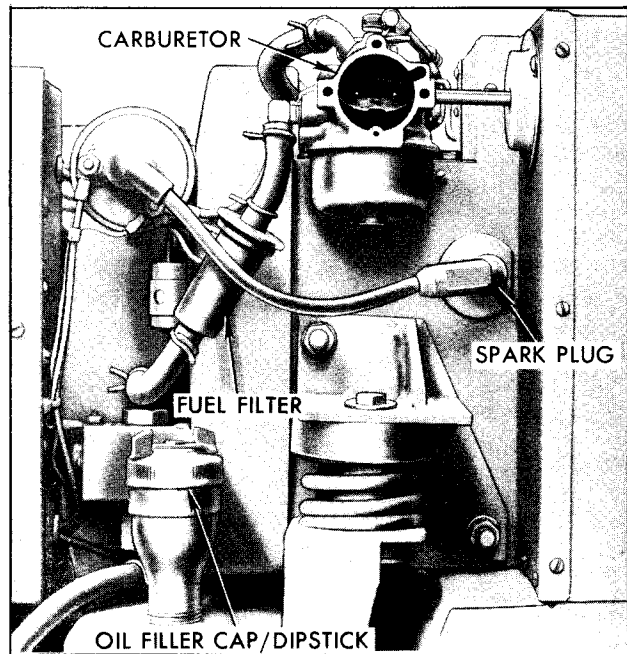

*Kohler Motor Generator*

## CAUTION

Do not remove the air cleaner unless temporary removal is necessary during repair or maintenance. When the air cleaner is removed backfiring can cause fire in the generator compartment.

## COOLING SYSTEM

"Kohler Air Vac" cooling is used on this unit. With this system, cooling air is drawn into the motor generator compartment, circulated from the generator end, around the cooling fins and finally ejected downward through the scroll on the engine.

Keep intake louvers, generator cooling openings, cooling fins and scroll work clean and unobstructed at all times to prevent overheating. Do not operate with blower housing, scroll or cooling shroud removed as this will also cause overheating.

## IGNITION SYSTEM

Every 100 operational hours, remove the spark plug and check its condition. Replace if necessary. Do not sand-blast, wire brush, scrape or otherwise service plug in poor condition. Best results are obtained with a new plug. Set spark



plug gap at .025". Tighten plug to 22 foot-pounds torque when installing.

Every 200 hours of operation the breaker points should be inspected. If the points are worn they should be replaced. The gap must be adjusted after points are serviced or replaced, since this setting establishes ignition timing. To adjust, turn engine over by hand until points are at maximum opening, check gap with feeler gauge. If gap is not .020", loosen adjusting screw then shift movable plate until .020" gap is obtained. After retightening screw, recheck the gap to make sure it is still properly set.

## FUEL FILTER

The fuel system is equipped with an in-line disposable fuel filter. This filter should be replaced every 100 operational hours. The filter is located in the fuel line just before the carburetor.

## BATTERY INSPECTION

If any cell is low on water, add colorless, odorless, drinking water and recharge.

Keep the battery clean and dry. An accumulation of moisture will lead to a more rapid discharge and battery failure.

Keep the battery terminals clean and tight. Coat the terminals with a light application of petroleum jelly or grease to retard corrosion. (See additional information pages 84-86).

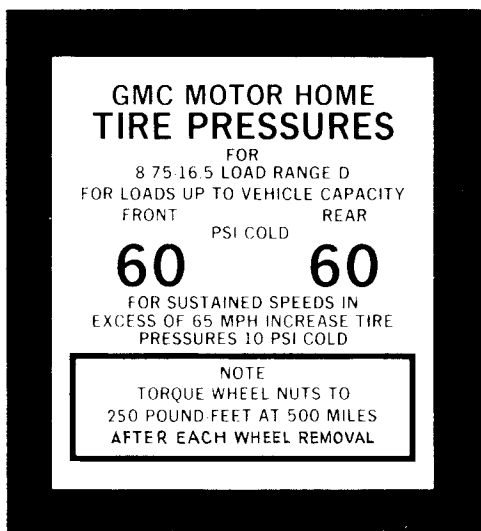

*Tire Pressure Placard*

## CAUTION

Never expose battery to open flame or electric spark—battery action generates hydrogen gas which is flammable and explosive. Don't allow battery fluid to contact skin, eyes, fabrics, or painted surfaces—fluid is a sulfuric acid solution which could cause serious personal injury or property damage. Wear eye protection when working with battery. Remove rings, metal watchbands and other metal jewelry before jump starting or working around a battery, and be careful in using metal tools—if such metal should contact the positive battery terminal (or metal in contact with it) and any other metal on the vehicle, a short circuit may occur which could cause personal injury.

## WHEELS AND TIRES

### TIRES

The factory installed tires on your vehicle are designed to provide the best all-around performance for normal vehicle operation. When inflated as recommended on the "Tire Pressure Placard," located on the glove compartment door of your vehicle, the tires have the load carrying capacity to operate satisfactorily at all normal highway speeds.

### Tire Care

Tires should be checked regularly for proper inflation pressure, wear, and damage. The following information will assist you in properly caring for your tires.

### Inflation Pressure

Tire inflation pressures listed on the tire placard have been selected to provide the best tire life, riding comfort and handling stability for normal driving conditions.

The use of improper tire inflation pressures can adversely affect tire life and vehicle performance. Too little air pressure can result in excessive tire heat, abnormal tire wear, adverse vehicle handling and reduced fuel economy. Too much air pressure can result in abnormal tire wear, adverse vehicle ride and handling, and increased susceptibility to damage by road impacts.

Tire pressures should be checked at least once a month (and preferably oftener) or before long trips or when heavily loaded. The following points should be observed when checking and setting tire pressures.

1. Cold tire pressure ratings are applicable when a vehicle has been inoperative for 3 hours, or more, or driven less than one mile.

2. Tire inflation pressure may increase as much as 6 psi when hot (after vehicle has been driven 10 miles or at speeds of more than 60 MPH). Do not "bleed" or reduce pressures when tires are hot from driving.

3. For continuous high speed operation (over 65 MPH), increase tire inflation pressure to 70 psi.

4. Always use a tire pressure gauge when checking tire pressure.

### **Tire Damage and Repair**

Tires with cuts, splits or cracks deep enough to expose the fabric, should be removed from service. Bulges usually indicate internal damage, and the tire should be removed. Tires with questionable damage should be removed from the wheel and examined by an expert.

If an air loss occurs while driving, do not attempt to drive on the deflated tire more than is necessary to stop safely. Driving even a short distance can damage a tire beyond repair.

Temporary repairs, such as "blowout" patches or any repair made from the outside of the tire should not be made except in emergencies. Such "stop-gap" devices as plugs and aerosol-type sealants are good for not more than 100 miles of driving at speeds not over 50 MPH. A permanent vulcanized repair, plug or patch applied from inside the tire, should be made as soon as possible. Also, the installation of an inner tube in a damaged tubeless tire is not a recommended repair procedure.

### **Replacement Tires**

When replacing tires, only the size (8.75-16.5), load range ("D"), construction type (bias-ply polyester cord, or bias-ply steel belted) are recommended for installation on the Motor Home.

#### **CAUTION**

**Radial tires are not recommended for installation on the Motor Home. Severe damage and possible personal injury could result.**

Use of any other tire may seriously affect ride, handling, speedometer/odometer calibration, vehicle ground clearance and tire clearance to the body and chassis. The following also should be considered when replacing tires:

- To achieve best all-around vehicle performance, bias-ply and bias-ply steel belted tires should not be mixed on the same vehicle.
- It is recommended that new tires be installed in pairs opposite each other (preferably the front wheels).
- When replacing only one tire, it should be paired with the tire having the least wear, to equalize braking traction.

### **Replacement Wheels**

When replacing wheels for any reason, care should be taken to ensure that the wheels are equivalent to those removed in diameter, rim width and off-set.

### **Tire Warranty**

Tires are warranted by the tire manufacturers as covered in the New Vehicle Warranty.

### **Tire Traction**

A decrease in driving, cornering, and braking traction occurs when water, snow, ice, gravel, or other material is on the road surface. Driving practices and vehicle speed should be adjusted to the road conditions.

When driving on wet or slushy roads, it is possible for a wedge of water to build up between the tire and road surface. This phenomenon, known as hydroplaning, may cause partial or complete loss of traction, which adversely affects vehicle control and stopping ability. To reduce the possibility of traction loss, the following precautions should be observed:

1. Slow down during rain-storms or when roads are slushy.
2. Slow down if road has standing water or puddles.
3. Replace tires when tread wear indicators are visible.
4. Keep tires properly inflated.

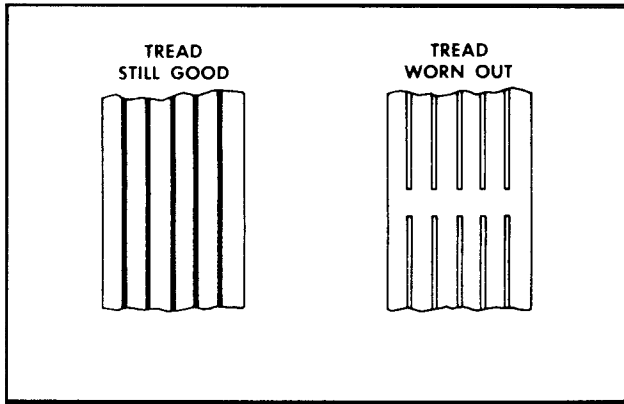

*Tire Tread Wear Indicator*

**Snow Tires**

If the vehicle is expected to encounter muddy or snowy driving conditions it is recommended that front driving wheels be equipped with mud and snow type tires.

If you equip your vehicle with mud and snow tires, they should be of the same size, load range, and construction as original equipment tires. It is recommended that vehicle speeds be limited to a maximum of 65 mph if mud and snow tires are installed.

**Tire Wear and Rotation**

Uneven or abnormal tire wear is usually the result of incorrect inflation pressure, improper wheel alignment, wheels being out-of-balance, or poor driving habits. Under-inflation, over-infla-

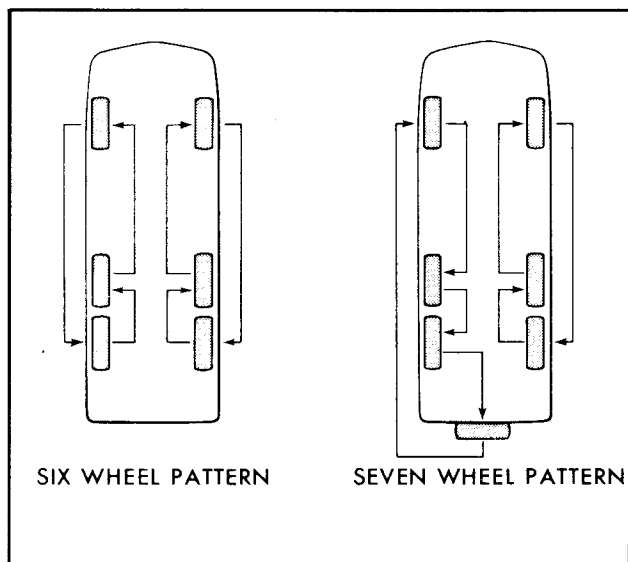

*Tire Rotation Diagram*

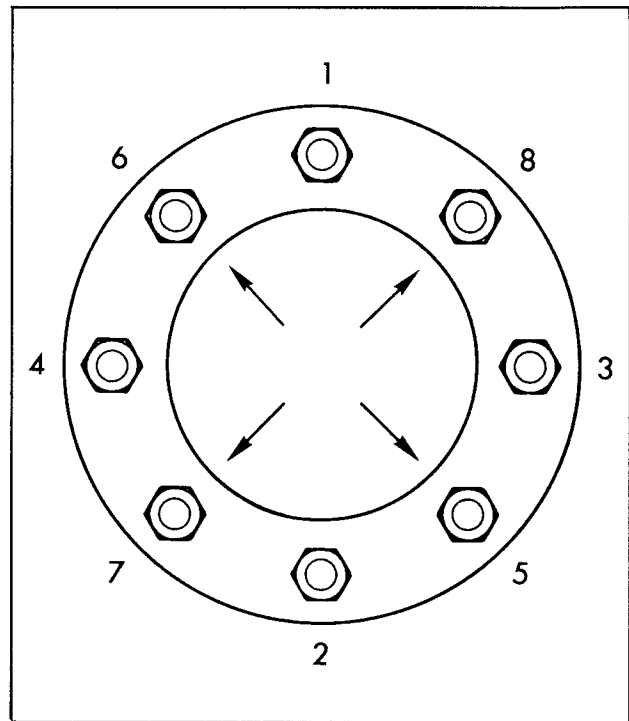

*Wheel Stud Tightening Sequence*

tion, incorrect toe or camber and fast cornering produce different types of abnormal wear which can be diagnosed by your dealer.

To equalize wear it is recommended that the tires be rotated every 6,000 miles (or sooner if irregular wear develops) as shown.

**NOTE:** It is recommended that disc brake pads be inspected for wear whenever tires are rotated.

The original equipment tires incorporate built-in tread wear indicators to assist you in determining when your tires have worn to the point of needing replacement. These indicators appear as 1/2-inch wide bands when tire tread depth is 1/16-inch or less. When the indicators appear in two or more adjacent grooves, tire replacement due to tread wear is recommended.

**Tightening Wheel Stud Nuts**

When Motor Home is new or after wheels have been replaced, it is the owner's responsibility to check wheel stud nuts at 500 miles and after every wheel removal thereafter. Nuts should be tightened to 250 foot-pounds torque in sequence shown.

## CAUTION

If any wheel experiences a single stud failure caused by a loose-running wheel, all wheel studs should be replaced.

A loose-running wheel may cause only one stud to break, but several more studs may become fatigued to the point of failure, but not actually breaking. Replacing only the broken stud and re-mounting wheel will then set the stage for a second and possibly more serious failure. If holes in the wheel have become elongated or enlarged, replace wheel.

Tighten wheel stud nuts as follows:

1. Install all nuts loosely, then finger-tighten only the nuts marked by arrows.
2. Tighten all nuts to specified torque in sequence illustrated. Never use oil or grease on studs or nuts.

See **IN CASE OF EMERGENCY** section for procedure used to change tire.

## FRONT WHEEL BEARING

Periodic maintenance on the front wheel bearing is not required. The front wheel bearing is a sealed bearing and is non-adjustable.

## REAR WHEEL BEARING ADJUSTMENT

A periodic rear wheel bearing repack is required as indicated in "Complete Vehicle Maintenance Schedule." These bearings should be cleaned and repacked with a Multi-Purpose E.P. Grease Meeting GM Specification 6031-M or equivalent.

The adjustment of the bearing must be done with the wheel off the floor, and rotating the wheel while tightening nut. At this time make the torque readings as follows:

1. Tighten adjusting nut with a torque wrench to 25-30 foot-pounds with wheel rotating to ensure that all parts are properly seated and threads are free.

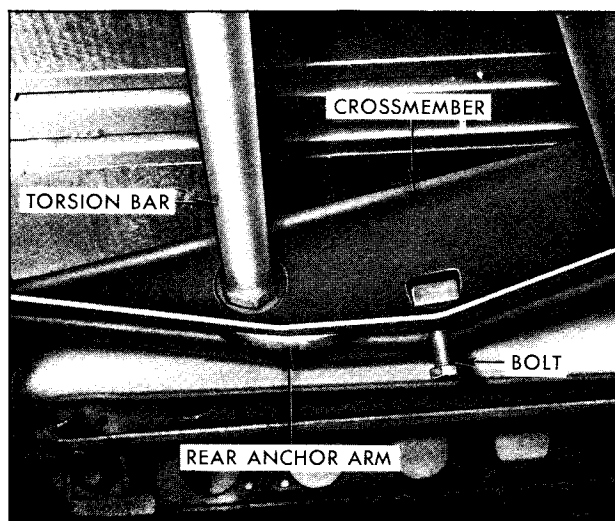

*Location—Front Ride Height Adjustment*

2. Back off nut one-half turn. Re-tighten nut finger-tight.
3. If unable to install cotter pin at finger-tight position, back off one slot, then secure in position.
4. End play should be .001" to .005". Also at this interval the rear suspension control arms should be lubricated. This is accomplished at the fittings between the rear wheels.

## FRONT SUSPENSION

The Motor Home front suspension consists of control arms, stabilizer bar, shock absorbers and a right and left torsion bar. The front suspension components are designed to provide satisfactory service, ride, and handling if not overloaded and adjusted to specified vehicle front end ride height.

No maintenance other than lubrication is normally required. Refer to lubrication information given earlier in this section for intervals and lubrication points.

The front of the torsion bar is attached to the lower control arm. The rear of the torsion bar is mounted into an adjustable arm. The front ride height is controlled by this adjustment.

The simplest way to adjust is to move arm slightly to achieve ride height and drive unit a few blocks so as to overcome delaying action.

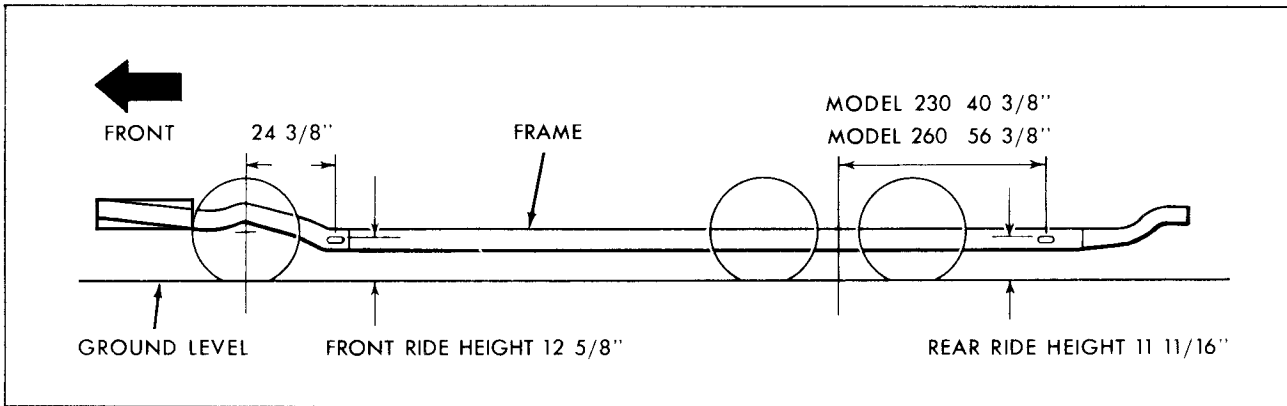

*Checking Motor Home Ride Height*

**NOTE:** Ride height is measured from top of elongated slot in frame rail to ground level. Tire inflation should be checked prior to making any ride height adjustment.

Ride height may be adjusted at bolt on rear anchor arm of torsion bar. Adjustment may be made by loosening or tightening bolt to wind-up or unwind torsion bar. Whenever ride height is changed, be sure to check front end alignment and readjust if necessary.

**NOTE:** Overloading and incorrect ride height can create serious problems and shorten the service life of the vehicle. Adjust front suspension ride height to specifications shown.

## REAR SUSPENSION

The rear suspension consists of control arms, mounting brackets, air bellows, shock absorbers, air compressor, air reserve tank, and height control valves. The system operates automatically as load varies, and is designed to maintain a constant frame height.

**NOTE:** Ride height is measured from top of elongated slot in frame rail to ground level. Tire inflation should be checked prior to making any ride height adjustments.

The rear suspension can be manually adjusted for variations in load distribution. Adjustment is made at the adjustment nut on the height control valve arm.

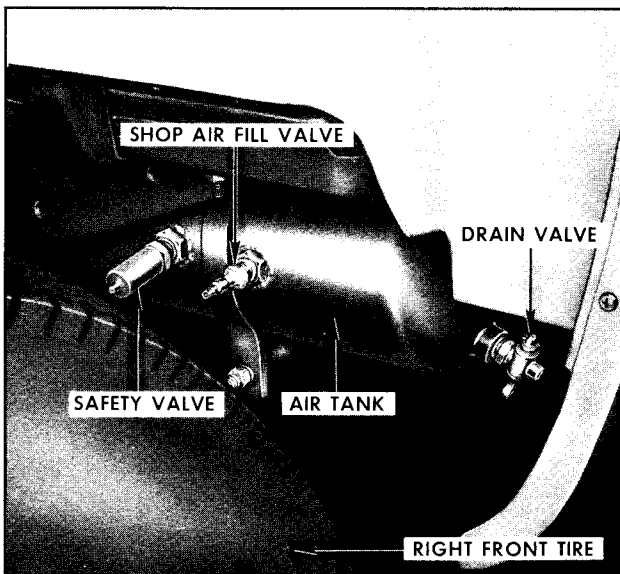

*Rear Suspension Air Reserve Tank*

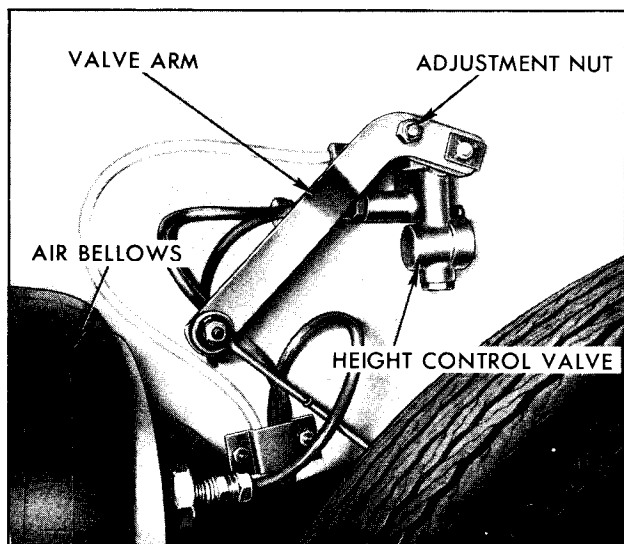

*Location—Rear Ride Height Adjustment*

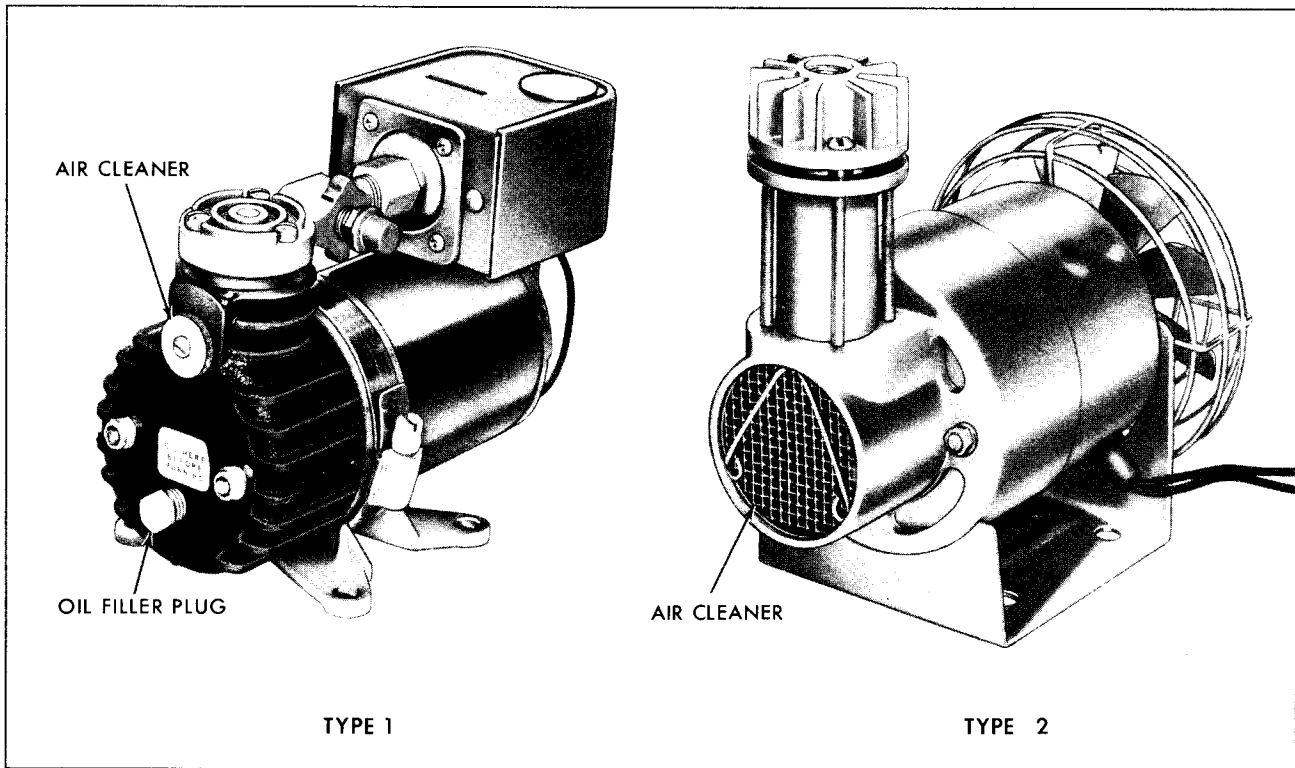

*Rear Suspension Air Compressors*

## MAINTENANCE

1. Drain air tank under right front of vehicle monthly to remove moisture.
2. Type 1 air compressor must have oil changed in spring and fall. Drain oil and refill with the same type of oil as used in the engine. In spring S.A.E. 20W-20 oil is used and S.A.E. 10W is recommended in fall.
3. Type 2 air compressor has sealed bearings and requires no periodic lubrication.
4. See "Complete Vehicle Maintenance Schedule" and procedures for instructions on air cleaner servicing procedures on both types of air compressors.

**NOTE:** Occasionally check air bellows to see if they are caked with accumulated mud deposits. If deposits are present remove them from air bellows.

## THERMASAN SYSTEM

The Thermasan System has been carefully designed to minimize the need for routine maintenance. All bearings are lifetime oiled and sealed. No lubrication is required. Furthermore, adjustments to the system are not required.

Thermasan components may adhere to the exhaust system, even though the contacting components are made of stainless and other special steels. Any time the Motor Home exhaust system is being worked on care should be taken not to damage any of the Thermasan components.

Occasional draining of the holding tank at an approved dumping station is recommended. This should be done at least annually to remove any foreign particles or other insoluble matter.

## STANDARD TOILET

There is no routine maintenance required on the standard toilet. If a problem occurs, check and make the appropriate correction.

### 1. PROBLEM:

- Water keeps running into the bowl.

### CAUSE:

- The blade in the bottom of the bowl is not closing completely, which in turn keeps the water control valve partially open.

The groove into which the blade seats when completely closed is clogged with foreign material. Odors could also leak up into vehicle.

**SOLUTION:**

- Depress foot pedal to expose blade seal.
- Insert the end of a coat hanger or similar object into the seating groove and remove the foreign material. Avoid damaging the rubber seal while cleaning.

**2. PROBLEM:**

- Toilet leaks. There is water on the floor.
- Specify the symptom. Determine if water is leaking from:
  - a. The vacuum breaker.
  - b. The water control valve.
  - c. Bowl to mechanism seal (if this is the problem, the water would not stay in the bowl).
  - d. Closet flange base seal.

**SOLUTION:**

- a. The vacuum breaker—if the vacuum breaker leaks when flushing the toilet, replace the vacuum breaker. (Toilet must be removed.)
- b. If the vacuum breaker leaks when the toilet is not in operation, replace the water control valve.
- c. Leaks at the bowl to mechanism seal—remove mechanism, and replace mechanism seal.
- d. Leaks at closet flange area—check front and rear closet flange nuts for tightness. If leak continues remove the toilet, check the closet flange height. The height should be between 1/4" and 7/16" above the floor. Adjust closet flange height accordingly and replace closet flange seal.

**3. PROBLEM:**

- Foot pedal operates harder than normal or blade sticks.

**SOLUTION:**

- Dry blade and apply a light film of Silicone spray to blade.

**4. PROBLEM:**

- Toilet fails to flush with pedal depressed.

**CAUSE:**

- Ball valve sheared off due to trying to flush toilet when water is frozen in valve.

**SOLUTION:**

- Replace ball valve. (Toilet must be removed.)

## RECIRCULATING TOILET

Routine maintenance is not required on the recirculating toilet other than recharging which is described in OPERATION OF LIVING AREA FACILITIES section earlier in this manual. If a problem occurs, check and make the appropriate correction.

**1. PROBLEM:**

- Toilet wobbles.

**CAUSE:**

- a. Closet retaining nuts not tight.
- b. Mounting brackets not seated to floor.
- c. Closet flange too high.
- d. Mounting surface uneven.

**SOLUTION:**

- a. & b. Tighten closet retaining nuts.
- c. & d. Check closet flange height by laying straight edge across flange and measuring gap between straight edge and floor at four (4) leg locations (1/4 to 7/16 inch is recommended).

**2. PROBLEM:**

- Toilet cycles when seat cover is raised.

**CAUSE:**

- Actuator button protrudes too far from the motor cover.

**SOLUTION:**

- Alternately press one side of the button, then the other, to work button back further into housing. If button still protrudes too far, replace timer assembly.

### 3. PROBLEM:

- Toilet does not cycle properly (5 to 9 seconds) when button is pressed.

#### CAUSE:

- Reversed wiring polarity.
- Battery run down.
- Branch wire too small.
- Damaged timer.

#### SOLUTION:

- The black wire is positive (hot) and the white wire is negative (ground).
- Recharge auxiliary (living area) battery.
- Branch wire should be #14 gauge minimum.
- Replace timer assembly.

### 4. PROBLEM:

- Flushing action is weak or noisy.

#### CAUSE:

- Pump is running backwards (reversed wiring polarity).
- Cycling unit without enough charge water.
- Pump damaged by continuous dry operation.

#### SOLUTION:

- The black wire is positive (hot) and the white wire is negative (ground).
- Charge to proper level (3 gallons). Fill to charge level (c) on indicator lens.
- Replace pump assembly.

### 5. PROBLEM:

- Lack of capacity.

#### CAUSE:

- Too much charge water.

#### SOLUTION:

- Use three gallons only to charge. Fill to charge level (c) on indicator lens.

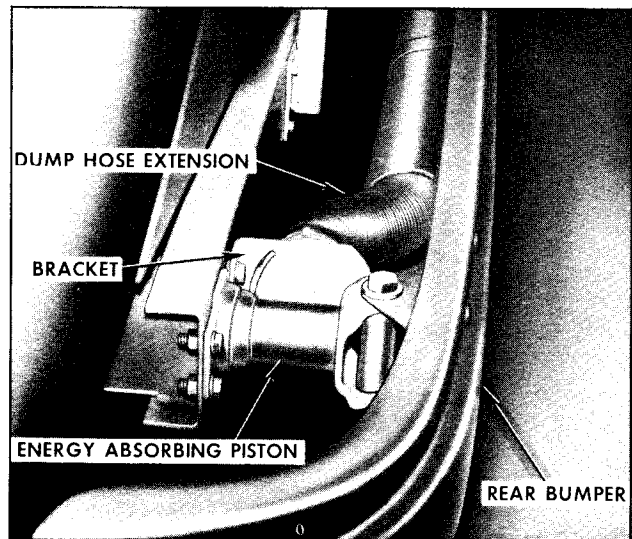

*Dump Hose Extension (Stored)*

## DRAINING HOLDING TANK

**NOTE:** If holding tank is allowed to overfill, the overflow will back up through the bathroom shower drain.

1. Be sure the holding tank valve is closed. It is located on the left-hand side of the vehicle just behind the left rear tandem tire.

2. Remove dump hose extension from the storage tube inside rear bumper. Hose is attached to bracket near the left rear energy absorbing piston. It may be removed by rotating hose adapter counterclockwise to remove from bracket.

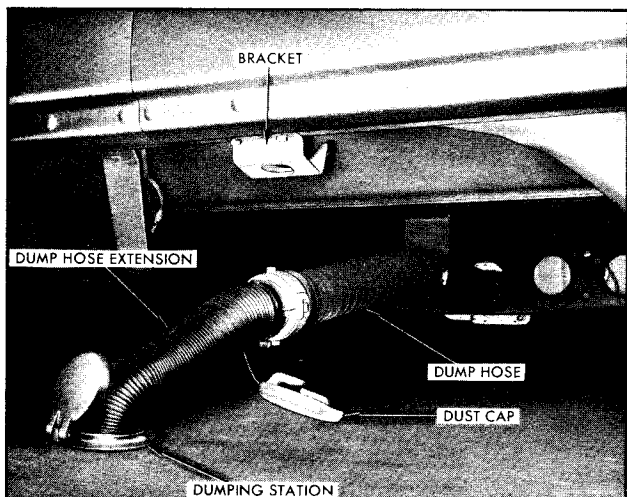

*Dumping Station Connection*



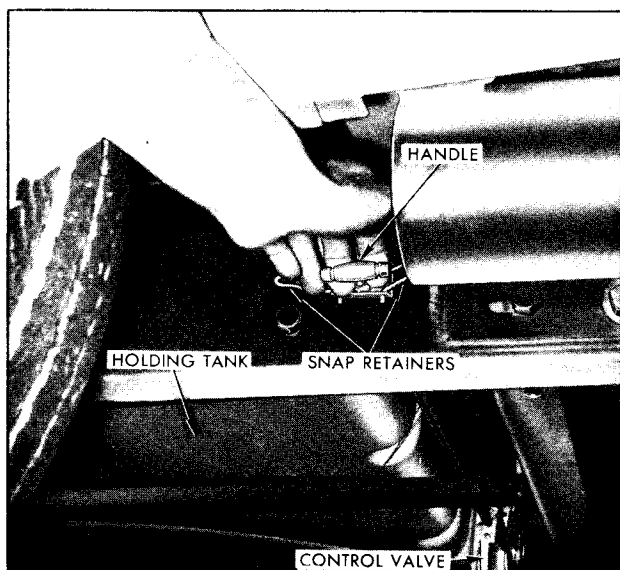

*Opening Holding Tank Control Valve*

3. Remove dump hose from bracket mounted to center of rear crossmember. Remove dust cap from dump hose.

4. Join dump hose extension to dump hose by rotating adapter clockwise.

5. Put end of dump hose extension into sanitary dumping station opening. Make sure there

are no sags in hose as this would prevent complete dumping.

6. Release two snap retainers at the control valve and pull handle straight out to open. This will drain holding tank completely.

**NOTE:** If you are using a sewer hook-up in a RV park keep the valve closed until you leave or the holding tank becomes full. This will allow solids to drain more readily.

7. After the holding tank is empty, it is recommended that the control valve be closed and several gallons of water be added to tank through the toilet. Then pull handle out to rinse tank. A garden hose may be left running into toilet with valve open to further rinse dump hose and extension.

8. It is advisable to add about 1/2-gallon of water and some non-toxic, non-flammable odor-control type chemical to holding tank.

9. Be sure to push control valve handle back in as far as it will go and re-latch two snap retainers to assure valve will be positively locked while traveling.

10. Restore extension to its tube and lock into bracket. Replace dump hose in its bracket with dust cap in place.

## DRAINING LIVING AREA WATER SYSTEM

1. Remove the water tank fill cap.

2. Open the holding tank dump valve, after making proper connection to approved dumping station.

3. Turn off water heater at switch located in Living Area Electrical Compartment.

4. Open the water drain valves at the water pump and the water tank, and the two water line drain cocks below the kitchen sink. Open the water heater drain cock.

5. Open kitchen and bathroom faucets.

6. Turn on water pump (if not already running).

7. With the standard toilet, depress the foot pedal until water no longer enters toilet bowl.

8. Allow system to drain.

9. Turn off water pump.

10. Disconnect intake and outlet hoses on water pump.

11. With the recirculating toilet, open the toilet water line fill valve and press the flush button.

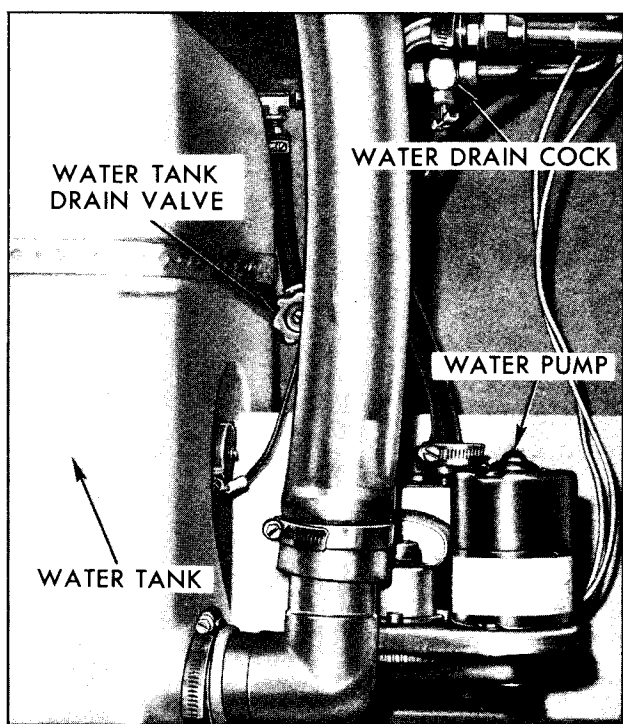

*Water Tank Compartment*

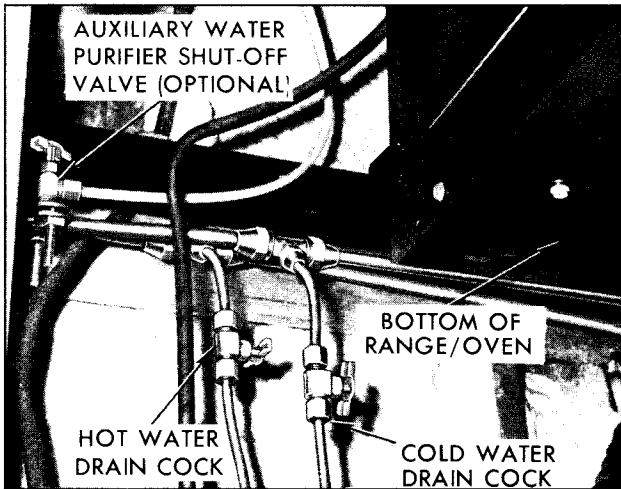

*Kitchen Drain Cocks*

12. Open shower head shut-off valve and turn the shower on at bathroom faucet. Extend shower head toward sink to allow the shower head and flexible hose to drain.

13. Depress button on the auxiliary water purifier (if equipped) to allow the line to drain.

14. Remove the hose connection cover (inside the external utilities door) and depress momentarily the button on the check valve to allow the line to drain.

15. Using low pressure (30 psi maximum), blow back through all faucets, forcing water from any low areas.

16. Connect water pump hoses and close all the water line drain cocks and valves including the water heater drain cock. Close kitchen and bathroom faucets, close toilet water line valve (if equipped). Close holding tank dump valve and latch. Stow holding tank tubes and replace dust cap. Replace water tank fill cap.

## SANITIZING LIVING AREA WATER SYSTEM

To help assure complete sanitation of your living area water system, it is recommended that the following procedures be followed on a new system, one that has not been used for a period of time, or one that may have become contaminated:

1. Prepare a chloride solution using one gallon of water and  $\frac{1}{4}$  cup of household bleach (5% sodium hypochlorite solution). Pour one

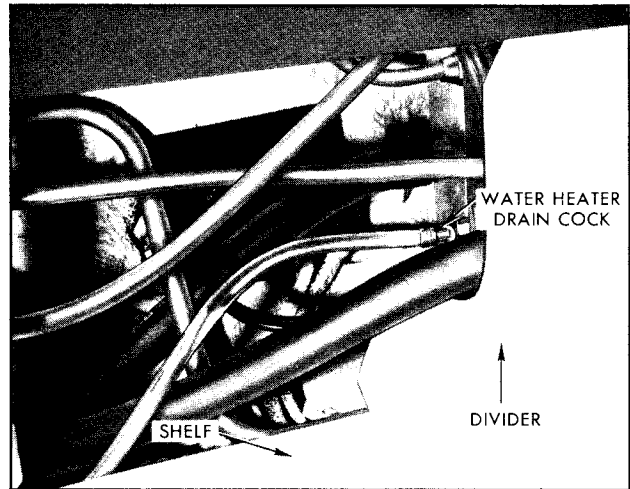

*Lower Bathroom Storage Compartment*

gallon of solution into water tank for each 15 gallons of tank capacity.

2. Complete filling of tank with fresh water. Open each faucet and drain cock until all air has been released from the pipes and entire system is filled.

3. Allow to stand for three hours.

4. Drain and flush with potable (drinkable) fresh water.

5. To remove any excessive chlorine taste or odor which might remain, prepare a solution with one quart of vinegar to five gallons of water and allow this solution to agitate in tank for several days by vehicle motion.

6. Drain tank and again flush with potable water.

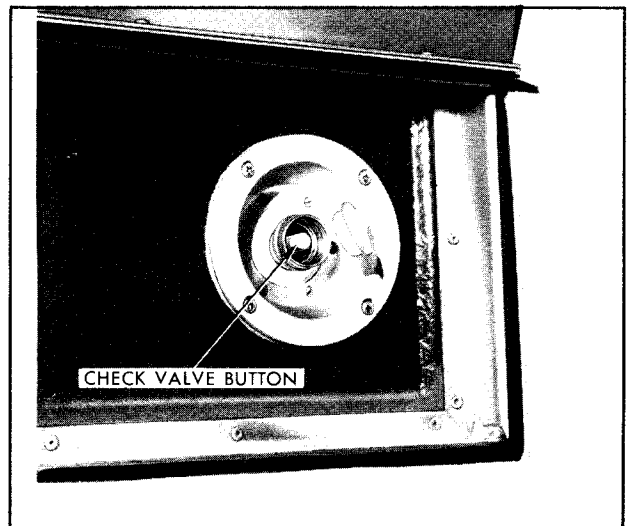

*External Water Connection*

## WINTERIZATION

When traveling in winter it is recommended that the water tank not be filled until the destination is reached. This will ensure that the vehicle has thoroughly warmed up. The water and holding tank systems should be drained before leaving for home. Also, an approved plastic pipe non-toxic, non-flammable antifreeze should be put in the sink and shower traps. If equipped with a recirculating toilet the standard winterization is to replace one-half of the charge water with an approved plastic pipe non-toxic, non-flammable antifreeze. This antifreeze added to the holding tank will help keep the tank contents from freezing.

See "Vehicle Storage" for additional information.

### CAUTION

**If your vehicle is equipped with a Therman waste destruction system, it is especially important that flammable cleaning agents, solvents or other highly combustible materials never be allowed to enter the holding tank via the kitchen or bathroom sinks, toilet or shower drains. These materials could create an explosion hazard in the vehicle exhaust system. For further information refer to the CAUTION and text under the "THERMASAN SYSTEM" in the section on OPERATION OF LIVING AREA FACILITIES.**

## VEHICLE STORAGE

Your Motor Home may be stored for considerable lengths of time provided the following steps are performed:

### 1. SHORT TERM STORAGE

#### —UP TO 60 DAYS AND ABOVE 32° F.

- a. Fill fuel tanks to reduce excessive build-up of moisture in the fuel tanks.
- b. Park Motor Home as level as possible, end for end and side to side.
- c. Wash Motor Home. If exposed to road salts the exterior and underside should be thoroughly washed and flushed.
- d. Check to make sure battery boost switch is left in the "BAT NORMAL" position. If left in the "BAT BOOST" position for extended periods, battery discharge will occur.
- e. Remove all perishables, leave refrigerator door open. Be sure controls are turned off.

f. Ventilate the living area, drawers, cabinets, closets, etc.

g. Drain the holding tank, toilet and living area water system as described earlier in this section. Be sure the water pump and water heater are turned off.

h. Turn off LP gas at tank valve.

i. Make sure furnace manual valve and thermostat are set at "OFF," range/oven burners at "OFF," oven at "PILOT OFF" and gas/electric refrigerator control at "GAS OFF."

j. Plug or tape all drains to retard evaporation of residual moisture in drain traps.

k. Tape over vents to prevent insects from entering. Be sure to remove tape before operating LP gas appliances, to help avoid poisoning by carbon monoxide (see caution at beginning of section on OPERATION OF LIVING AREA FACILITIES).

l. Check Motor Home weekly to ensure that undesirable conditions are not forming (water seepage, mold, odors, etc.). Household air deodorizers or disinfectants in aerosol cans may be used as required, however, do not spray directly on any surface.

m. Maintain tire pressure of 60 psi.

n. Crack one window for ventilation, close all others as well as roof vents.

o. Check batteries (main, auxiliary and motor generator, if equipped) for charge. Specific Gravity reading of 1.255 is required to prevent deterioration. Add colorless, odorless drinking water, if necessary (see pages 84-86).

p. Turn off radio, exterior lights, and interior lights.

q. If Motor Home is to be moved, run engine at least two minutes with the transmission selector in "PARK."

r. Start and run engine for approximately 15 minutes weekly. Check engine, transmission and motor generator oil levels. Dipsticks should always be properly seated on tubes to prevent moisture from entering.

### 2. LONG TERM STORAGE

#### —60 DAYS OR MORE AND ABOVE 32° F.

a. Perform all of the above steps except for Step r.

b. Motor Homes without automotive air conditioning; remove spark plugs and squirt each cylinder with "Super Engine Oil Supplement" available at your GMC Motor Home service outlet. Replace spark plugs.

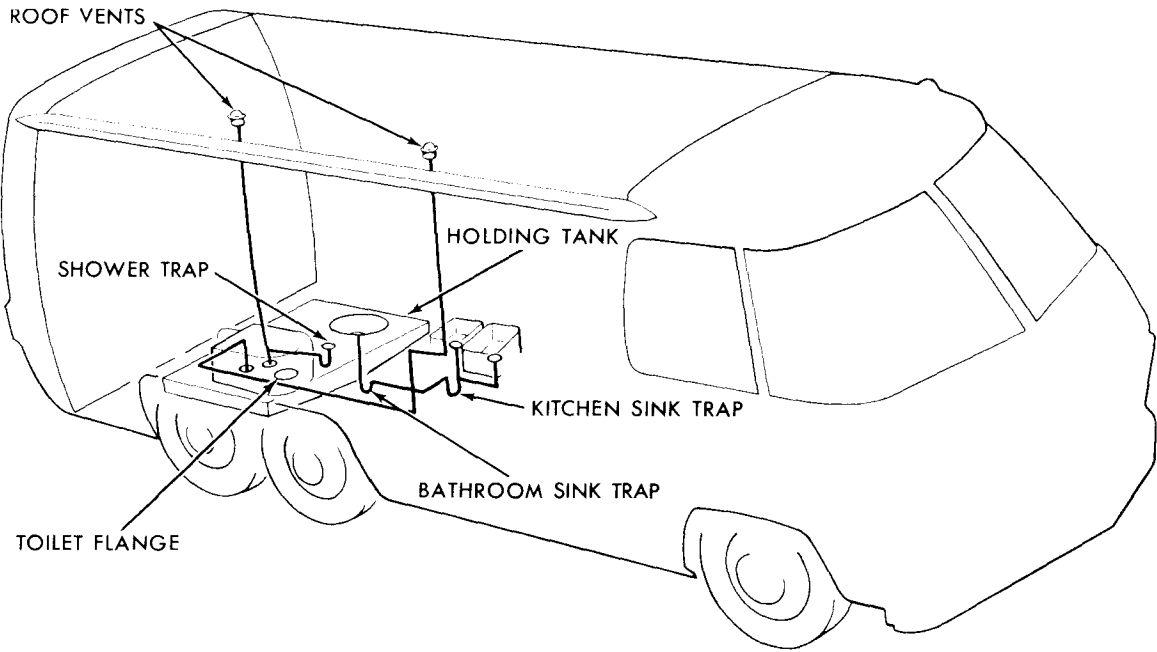

*Drainage System (Model 230)*

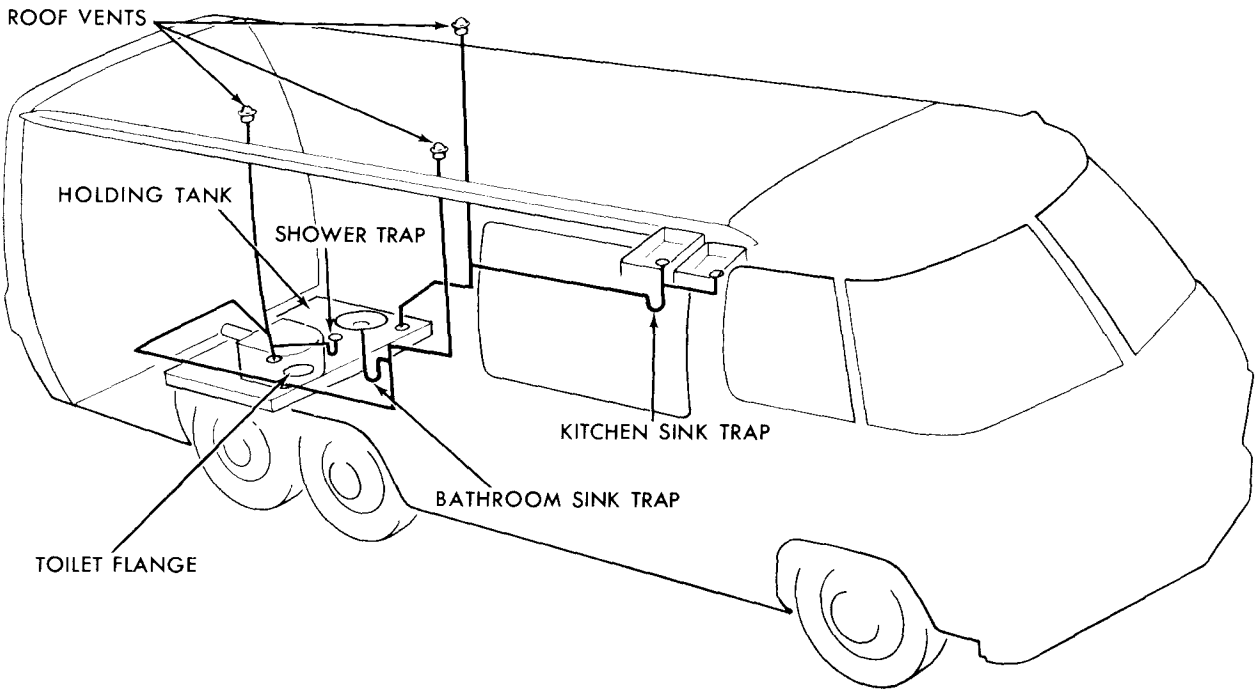

*Drainage System (Model 260)*

c. Motor Homes with automotive air conditioning; run engine approximately 15 minutes with automotive air conditioning controls turned to "ON" position. Perform this operation every 30 days.

d. Treat all bright metal and rubber surfaces with a wax emulsion applied with a brush. A good liquid floor wax or equivalent is satisfactory.

e. Disconnect batteries, and check Specific Gravity every 30 days. See additional instructions for batteries under "Chassis Electrical System" given earlier in this section.

### 3. WINTER STORAGE—BELOW 32° F.

a. While many of the steps in preparing your Motor Home for storage when temperatures go below 32° F. are the same as preparing for storage above 32° F., freezing temperatures present an additional hazard.

b. Fill fuel tanks to reduce excessive build-up of moisture in the fuel tanks.

c. Check coolant level and add antifreeze if required, to protect to the lowest expected temperature during storage (at least -20° F.).

d. Change engine oil as shown on the recommended S.A.E. Viscosity Chart to aid cold weather starting.

e. Park Motor Home as level as possible, end for end and side to side.

f. Wash Motor Home. If exposed to road salts, the exterior and underside should be thoroughly washed and flushed.

g. Check to make sure battery boost switch is left in the "BAT NORMAL" position. If left in the "BAT BOOST" position for extended periods, battery discharge will occur.

h. Remove all perishables and anything which may freeze (canned goods, medicine, etc.). Leave the refrigerator door open. Be sure controls are turned off.

i. Ventilate the living area, drawers, cabinets, closets, etc.

j. Drain the holding tank, toilet and living area water system as described earlier in this section. Be sure the water pump and water heater are turned off.

k. Turn off LP gas at tank valve.

l. Make sure furnace manual valve and thermostat are set at "OFF," range/oven burners at "OFF," oven at "PILOT OFF," and gas/electric refrigerator control at "GAS OFF."

m. Add recreational non-toxic, non-flammable antifreeze (½ cup) to the kitchen, bathroom, and shower drains (see page 107).

n. Tape over drain openings (except toilet) to prevent evaporation if storage is lengthy (6 months or more).

o. Crack one window for ventilation, close all others as well as roof vents.

p. Start and run engine weekly for approximately 20 minutes. If very low temperatures are expected the batteries should be removed and stored in a warmer area (see pages 84-86).

q. Check engine transmission and motor generator (if equipped) for evidence of oil leaks.

r. Maintain tire pressure of 60 psi.

s. Remove accumulations of snow as often as possible.

t. Turn off radio, exterior lights, and interior lights.

u. Tape over vents to prevent possible entry of snow. Be sure to remove tape before operating LP gas appliances, to help avoid poisoning by carbon monoxide (see caution at beginning of section on OPERATION OF LIVING AREA FACILITIES).

v. Before moving, run engine at least two minutes with the transmission selector in "PARK" position.

### ONAN MOTOR GENERATOR STORAGE

If the motor generator will be out of service for more than 30 days, the following steps should be taken to protect the unit.

1. Run the unit until thoroughly warm.

2. Disconnect fuel supply and run until unit stops.

3. Drain oil from crankcase while still warm. Refill and attach a warning tag stating oil viscosity used.

4. Remove each spark plug. Pour one ounce of rust inhibitor (or S.A.E. 50 oil) into each cylinder. Crank engine several times. Install spark plugs.

5. Service air cleaner.

6. Clean governor linkage and protect by wrapping with a clean cloth.

7. Plug exhaust outlet to prevent entrance of moisture, dirt, bugs, etc.

8. Wipe entire unit with a clean cloth. Coat rustable parts with a light film of grease or oil.

## KOHLER MOTOR GENERATOR STORAGE

If the motor generator will not be used for an extended period of time, follow this procedure:

1. Drain oil from crankcase (while hot), then flush with clean light oil. Refill crankcase after flushing.

2. Drain fuel from sediment bowl and carburetor.

3. Clean exterior of plant, then spread a light film of oil on unpainted metal surfaces.

4. Remove spark plug and pour a tablespoon of oil (S.A.E. 30) into spark plug hole, turn engine over several times. Spark plug should be reinstalled.

5. Service air cleaner.

6. Plug exhaust outlet to prevent entrance of moisture, dirt, bugs, etc.

**For continuing satisfaction keep your Motor Home all GM. General Motors Parts are identified by one of these trademarks:**

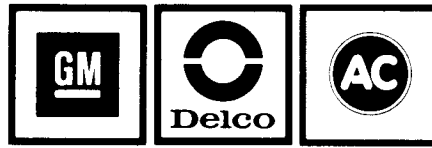



# GMC MOTOR HOME NEW VEHICLE WARRANTY AND POLICY ON OWNER SERVICE

_____	
Owner's Name	
_____	
Street Address	
_____	_____
City and State	Zip Code
_____	
Vehicle Identification No.	
_____	
Date of Delivery to First Retail Purchaser (Service Date If Applicable)	
_____	
Vehicle Mileage at Time of Such Delivery	
_____	_____
Selling Dealer Name	Dealer Code
_____	
Street Address	
_____	
City and State	

**IMPORTANT — This warranty must be kept with the Motor Home at all times and made available to an authorized GMC Motor Home Service Outlet if warranty work becomes necessary. The warranty should remain with the Motor Home at time of resale.**

## GMC MOTOR HOME NEW VEHICLE WARRANTY

### WHAT IS WARRANTED AND FOR HOW LONG

GMC Truck (GMC Truck & Coach Division, General Motors Corporation) warrants to the owner of each GMC Motor Home (hereinafter called "Motor Home") that for a period of 12 months or 12,000 miles, whichever first occurs, it will repair any defective or malfunctioning part of the Motor Home — except tires and tubes which are warranted separately by the tire manufacturer. This warranty covers only repairs made necessary due to defects in material or workmanship.

The 12 month/12,000 mile warranty period shall begin on the date the Motor Home is delivered to the first retail purchaser or, if the Motor Home is first placed in service as a demonstrator or company Motor Home prior to sale at retail, on the date the Motor Home is first placed in such service.

### WHAT IS NOT COVERED BY THE WARRANTY

This warranty does not cover:

1. Conditions resulting from misuse, negligence, alteration, accident, lack of performance of required maintenance services, or overloading beyond the applicable weight rating;
2. Special body conversions or equipment not manufactured or supplied by GMC Truck;
3. Any part of the Motor Home which fails or malfunctions as a result of improper conversion or installation of special equipment by other manufacturers or suppliers;
4. The replacement of maintenance items (Such as spark plugs, ignition points, positive crankcase ventilation valve, filters, brake linings) made in connection with normal maintenance services;

*(Continued)*



## **GMC MOTOR HOME NEW VEHICLE WARRANTY (Continued)**

5. Loss of time, inconvenience, loss of use of the Motor Home or other consequential damages;
6. Any Motor Home on which the odometer mileage has been altered and the Motor home's actual mileage cannot be readily determined; or
7. Any Motor Home registered and normally operated outside the United States or Canada. The warranty for these Motor Homes shall be that authorized for the country in which the Motor Home is registered and normally operated.

### **GMC TRUCK'S OBLIGATIONS**

1. Repairs qualifying under this warranty will be performed by any authorized GMC Motor Home Service Outlet within a reasonable time following delivery of the Motor Home to the Service Outlet's place of business.
2. GMC Truck will pay the authorized GMC Motor Home Service Outlet for any repairs under the warranty.

### **OWNER'S OBLIGATIONS**

1. The Motor Home must be delivered to an authorized GMC Motor Home Service Outlet's place of business during regular business hours for performance of warranty repairs or service adjustments.
2. The owner is responsible for maintenance services which may be performed at the owner's option by any repair outlet regularly performing such services.

~~~~~  
This is the only express warranty applicable to the GMC Motor Home and GMC Truck neither assumes nor authorizes anyone to assume for it any other obligation or liability in connection with such Motor Home or chassis.

### **WHAT TO DO IF THERE IS A QUESTION REGARDING WARRANTY**

The satisfaction and goodwill of owners of GMC Truck Motor Homes are of primary con-

cern to GMC Motor Home Service Outlets and GMC Truck & Coach Division. In the event a warranty matter is not handled to your satisfaction, the following steps are suggested:

1. Discuss the problem with your GMC Motor Home Service Outlet management.
2. Contact the GMC Truck Zone Office closest to you as listed in the GMC Motor Home Owner's Manual.
3. Contact the Customer Services Manager at the address below:

GMC Truck & Coach Division  
General Motors Corporation  
Pontiac, Michigan 48053

### **TIRES**

Tires and tubes are covered by the tire manufacturer's guarantee. While the guarantees of the various tire manufacturers vary in language, they provide in general that Motor Home tires installed as original equipment at the factory are guaranteed to the owner to be free from defects in material and workmanship for the life of the original tread, as follows:

The tire manufacturer will, at its option, repair the tire or tube without charge or make a pro rata allowance based on the amount of wear on the original tread toward the purchase of a new tire or tube at the tire manufacturer's current Adjustment Base Price for any tire or tube which is found by the tire manufacturer to be defective. Transportation costs and taxes must be paid by the owner and service charges may be made in some instances.

The above described tire guarantees are the only ones issued by the tire manufacturers, and they specifically provide that consequential damages are not covered by the guarantees.

Any authorized GMC Motor Home Service Outlet will assist you in requesting an adjustment if this becomes necessary. For the added convenience of owners, many GMC dealers are equipped to handle tire warranty adjustments on tires provided by GMC Truck on GMC Motor Homes.

## **POLICY ON GMC MOTOR HOME OWNER SERVICE**

- 1. New Vehicle Warranty** — A Motor Home is eligible for warranty service only if it qualifies under the provisions of the warranty and the owner possesses a New Vehicle Warranty issued by GMC Truck for such Motor Home. This warranty should be delivered to the person to whom you sell your Motor Home.
- 2. Delivery** — To help you secure maximum satisfaction with your Motor Home, it has been serviced and conditioned according to GMC's established new Motor Home inspection procedure by the authorized GMC Motor Home Service Outlet who sold you your Motor Home.
- 3. Maintenance Services** — Your GMC Motor Home Owner's and Driver's Manual contains important maintenance information. Read this publication carefully and follow the recommendations therein to help assure enjoyable and satisfactory operation of your Motor Home. Proper maintenance and care of your Motor Home will help you achieve lower overall operating costs. Also, regular and proper maintenance by competent technicians will help you avoid conditions arising from negligence which are not covered by the GMC Motor Home New Vehicle Warranty.
- 4. Warranty Service** — United States and Canada — If you are touring or in the event you move, service under the GMC Motor Home Vehicle Warranty will be performed by any GMC Motor Home Service Outlet in the United States or Canada. In all other cases, it is recommended that warranty services be performed by the authorized GMC Motor Home Service Outlet who sold you your Motor Home because of the Service Outlet's continued and personal interest in you.
- 5. Warranty Service** — Foreign Countries — The GMC Motor Home New Vehicle Warranty set forth in this folder also applies to your Motor Home if you are touring in

*(Continued on next page)*

## **POLICY ON GMC MOTOR HOME OWNER SERVICE (Cont.)**

a foreign country and the Motor Home is registered and normally operated in the United States or Canada.

Where authorized General Motors Dealer service is not available in the country in which you are touring and warranty repairs become necessary, you should obtain paid receipts covering the work from the service station or garage that performed the necessary repairs. Upon your return to the United States or Canada, a statement of the circumstances relative to the warranty work performed, along with the paid receipts, should be given to your GMC Motor Home Service Outlet for review and reimbursement consideration.

- 6. Demonstrators and Company Motor Homes** — On a GMC Motor Home which has been in Dealer or General Motors service (such as a demonstrator, driver training or company vehicle), the warranty time and mileage limitations are calculated from the date the Motor Home is first placed in service by the Dealer or General Motors.
- 7. Production Changes** — GMC Truck and authorized GMC Motor Home Service Outlets reserve the right to make changes in Motor Homes manufactured and/or sold by them at any time without incurring any obligation to make the same or similar changes on Motor Homes previously manufactured and/or sold by them.
- 8. Paint and Other Appearance Items** — Imperfections in paint, trim or other appearance items are normally apparent and corrected during new Motor Home inspection. For your protection, we suggest that if you find any paint or appearance imperfection, you call it to the attention of your GMC Motor Home Service Outlet without undue delay, as normal deterioration due to use and exposure is not covered by the GMC Motor Home New Vehicle Warranty.

# EMISSION CONTROL SYSTEMS INFORMATION AND WARRANTY

**IMPORTANT: This warranty and information is applicable to the GMC Motor Home for a period of 5 years or 50,000 miles, whichever occurs first, and should remain with the Motor Home at time of resale.**

---

## FOREWORD

---

### FEDERAL CLEAN AIR ACT

The Clean Air Act requires the vehicle manufacturer to furnish, with each new Motor Home, such written instructions for the maintenance and use of the vehicle by the ultimate purchaser as are reasonable and necessary to assure the proper functioning of emission control devices and systems installed in the Motor Home by GMC Truck & Coach Division. This information, along with your "Complete Vehicle Maintenance Schedule," are being provided to owners in compliance with the law.

### NORMAL VEHICLE USE

The owner's maintenance instructions contained in the maintenance schedule are based on the assumption that your Motor Home will be used as designed:

- To carry passengers and cargo within the limitations indicated on the vehicle identification plate affixed under the front access door on the driver's toe panel.
- On reasonable road surfaces within legal operating limits.
- On unleaded or low-lead fuel.

Unusual operating conditions will require more frequent vehicle maintenance as specified in the "Explanation of Complete Vehicle Maintenance Schedule" on page 68.

### MAINTENANCE SOURCE AND EVIDENCE

The required owner emission control systems maintenance operations presented in the maintenance schedule should be performed by an authorized GMC Motor Home Service Outlet or any other qualified service outlet which regularly performs such services. Service manuals, providing greater detail on emission systems, are made available for purchases by owners who desire to perform their own vehicle maintenance.

Receipts covering the performance of regular maintenance should be retained in the plastic envelope provided, in the event questions arise concerning maintenance. These receipts should be transferred to each subsequent owner of this Motor Home.

### RECOMMENDATIONS FOR REQUIRED MAINTENANCE SERVICE REPLACEMENT PARTS

The emission control systems of your Motor Home were designed, built and tested using genuine GM Parts\* and the vehicle is certified as being in conformity with Federal regulations implementing the Clean Air Act. Accordingly, it is recommended that any replacement parts used for required maintenance services or for the repair of emission control systems be new, genuine GM parts. Use of replacement parts which are not of equivalent quality may impair the effectiveness of such systems.

**\*Genuine GM Parts**, when used in connection with GMC Truck & Coach vehicles, means parts manufactured by, or for GMC Truck & Coach Division, designed for use on GMC vehicles and distributed by GMC Truck & Coach Division or any Division or subsidiary of General Motors Corporation.

If other than new genuine GM parts are used for required maintenance service replacements or for the repair of components affecting emission control, the owner should assure himself that such parts are warranted by their manufacturer to be equivalent to genuine General Motors parts in performance and durability.

Listed below are the components affecting emissions performance of your GMC Motor Home:

- Carburetor
- Carburetor Air Cleaner Element
- Carburetor Fuel Filter
- Spark Plugs
- Spark Plug Wires
- Distributor
- Fuel Tanks (Including Vapor-Liquid Separator)
- Fuel Tank Cap
- Evaporation Control System Carbon Canister(s) and Hoses
- Carbon Canister Filter
- Thermostatically Controlled Air Cleaner
- Positive Crankcase Ventilation Valve
- Positive Crankcase Ventilation Filter
- Thermal Vacuum Switch

## EMISSION CONTROL SYSTEMS

### SOURCE OF EMISSIONS

During the combustion process in an automotive engine, some of the fuel (hydrocarbons) fails to burn completely and is discharged into the engine crankcase or exhaust system. Additional hydrocarbons are emitted into the atmosphere through evaporation of gasoline vapors from the fuel tank and carburetor. Of the total hydrocarbons coming from uncontrolled vehicles, about 20% are emitted from the crankcase, 20% from the fuel system and 60% from the engine exhaust.

In addition to hydrocarbons, carbon monoxide and oxides of nitrogen are also formed during the combustion process. These are also discharged into the exhaust system.

### WHAT GENERAL MOTORS HAS DONE

Since research on the control of vehicle emissions first began some 20 years ago, General Motors has developed a number of control systems which are highly effective in reducing undesirable emissions.

Control of hydrocarbon emissions is important since, when subjected to sunlight under certain conditions, they react with other gases to form photochemical smog, which is prevalent in some geographical areas. Carbon monoxide does not enter into the complex photochemical smog reaction, but it is toxic at high concentrations and, thus, has been controlled to prevent high atmospheric concentrations.

### GASOLINE IMPROVEMENTS

Another important advancement in air pollution control has been the reduction in lead level or elimination of lead from some grades of gasoline. (Certain lead compounds have been used for many years as additives to increase octane ratings.) Use of unleaded or low-lead gasoline will keep your engine running efficiently and play an important part in reducing exhaust emissions of hydrocarbons and particulates. See page 81 for additional information on fuel requirements.

### CRANKCASE CONTROLS Positive Crankcase Ventilation (PCV)

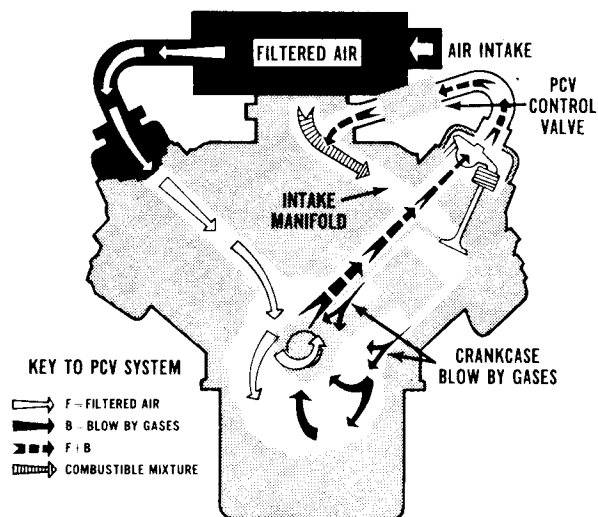

All General Motors gasoline engine powered vehicles are equipped with Positive Crankcase Ventilation—a system which permits no crankcase emission to be discharged into the atmosphere. To function properly, the system depends on the PCV Valve which returns blow-by gases to the combustion chambers where they are burned.

### EXHAUST CONTROLS Controlled Combustion System (CCS)

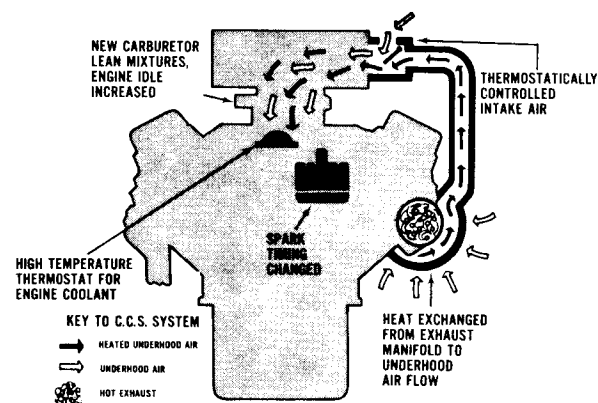

One method of controlling exhaust emissions involves the Controlled Combustion System (CCS) which is entirely separate from the Positive Crankcase Ventilation System. CCS is designed to reduce pollutants in the exhaust by improving the combustion process. It consists of a combination of design features including a special air cleaner which incorporates thermostatic control of heated air to the carburetor, a special calibrated carburetor and distributor and a modified combustion chamber design.

### Thermostatic Vacuum Switch (TVS)

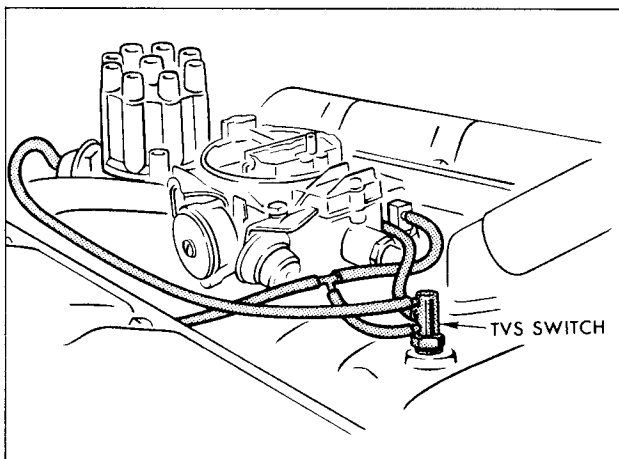

The retarded spark setting at idle speeds required for effective emission control makes engines tend to run hotter during idle or low speed conditions.

To protect against overheating, the engine is equipped with a thermostatic vacuum switch (TVS). This temperature-sensitive switch and valve assembly is mounted in the engine cooling jacket near the front of the engine and connected into the vacuum advance system.

When the engine coolant reaches a specified high temperature, the valve opens against spring pressure and directs manifold vacuum to the advance mechanism. This advances the spark timing slightly and speeds up the engine. The result is less heat rejected to the coolant together with higher fan speeds for better cooling action. When the engine has cooled down, the TVS switch moves the valve back to retard spark timing.

### FUEL EVAPORATION CONTROLS

#### Evaporation Control System (ECS)

The GMC Motor Home is equipped with an Evaporation Control System (ECS) which is designed to minimize the escape of fuel vapors to the atmosphere. Included in the system are special fuel tanks, liquid-vapor separator, filler cap, carbon canister(s), canister purge hoses, and carburetor modifications. Fuel vapors which would otherwise escape to the atmosphere are directed into the carbon canister(s). The carbon absorbs the vapors and stores them. The vapor is removed from the canister(s) during periods of engine operation as manifold vacuum draws the vapors into the engine and burns them.

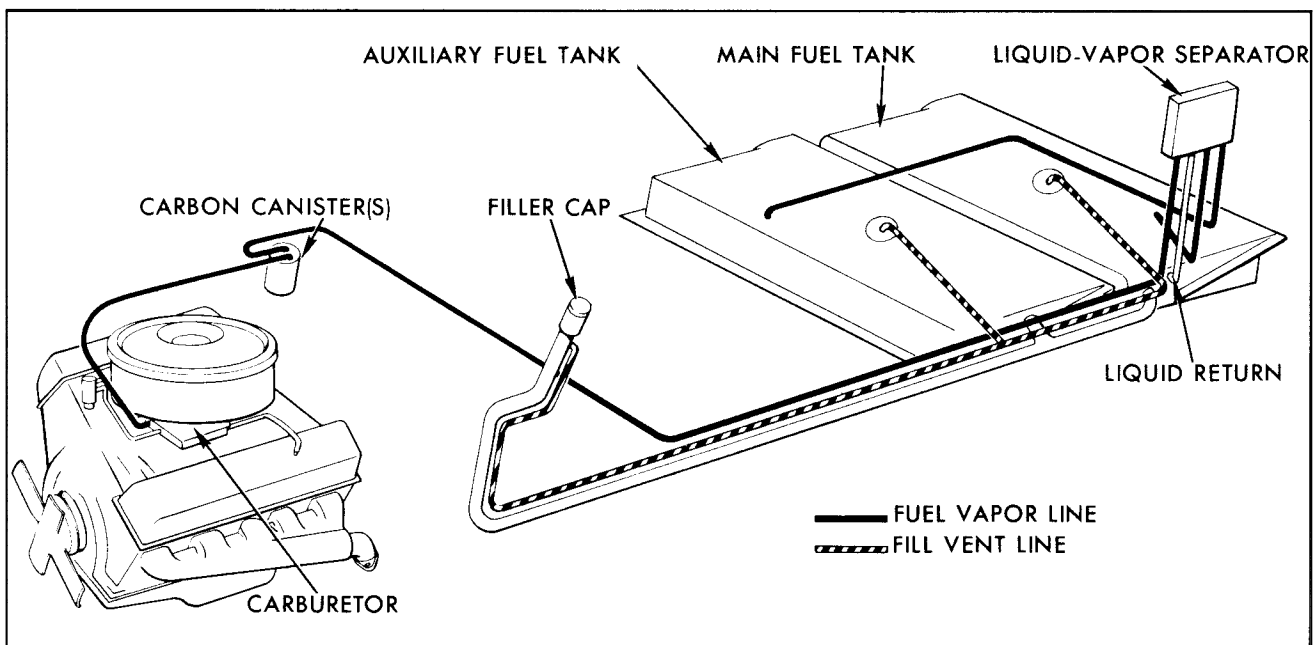

*Evaporation Control System (ECS)*

**NOTE:** The General Motors Evaporation Control System is designed to control evaporation losses from your vehicle under normal conditions using 9-lb. (Reid Vapor Pressure) fuel specified by Federal and California test requirements. However, if you should use fuel of abnormally high volatility for existing temperature conditions, you

may detect a gasoline odor during or after driving in heavy traffic. If you notice a fuel odor, the fuel system should be inspected and any leaks repaired or damaged parts replaced. If the system is intact and the odor persists, use a lower volatility fuel.

## **GMC MOTOR HOME EMISSION CONTROL SYSTEMS WARRANTY**

GMC Truck (GMC Truck & Coach Division, General Motors Corporation) warrants to the original and each subsequent owner of a GMC Motor Home that the engine (1) was designed, built, and equipped so as to conform at the time of sale with applicable regulations of the Federal Environmental Protection Agency, and (2) is free from defects in materials and workmanship at the time of sale which will cause the engine to fail to conform with applicable Federal Environmental Protection Agency regulations for a period of use of 50,000 miles or 5 years, whichever occurs first:

The 5-year/50,000-mile warranty period shall begin on the date the Motor Home is delivered to the first retail purchaser or, if the Motor Home first placed in service as a demonstrator or company vehicle prior to sale at retail, on the date the Motor Home is first placed in such service.

This warranty does not cover:

1. Malfunctions resulting from misuse, negligence, alteration, accident, or lack of performance of required maintenance services.
2. The replacement of expendable maintenance items which are spark plugs, ignition points, positive crankcase ventilation valve, filters, hoses, belts, wires and coolant made in connection with required emission control maintenance services.
3. Loss of time, inconvenience, loss of use of the Motor Home or other consequential damages.
4. Any Motor Home on which the odometer mileage has been altered and the Motor Home's actual mileage cannot be readily determined.
5. Any Motor Home registered and normally operated outside the United States.

GMC Truck & Coach Division's responsibility in respect to claims is limited to making required repairs, and no claim of breach of warranty shall constitute a cause for cancellation of the contract of sale of this vehicle.

Repairs qualifying under this warranty will be performed by any authorized GMC Motor Home Service Outlet within a reasonable time following delivery of the Motor Home to the Service Outlet's place of business during regular business hours. The Service Outlet must be furnished with the New Vehicle Warranty and Policy on Owner Service booklet for preparation of the work order to be signed by the owner.

\* \* \*

This is the only express emission control systems warranty applicable to GMC Motor Home engine and GMC Truck & Coach Division neither assumes nor authorizes anyone to assume for it any other obligation or liability in connection with such systems. This warranty is in addition to the GMC Motor Home New Vehicle Warranty.

**GMC TRUCK & COACH DIVISION  
GENERAL MOTORS CORPORATION  
Pontiac, Michigan 48053**

# GENERAL DATA AND SPECIFICATIONS

## VEHICLE IDENTIFICATION NUMBER

In order that your vehicle may be specifically identified as to manufacturer, engine type, model year, etc., refer to chart below.

(TYPICAL IDENTIFICATION NUMBER TZE033V100053)

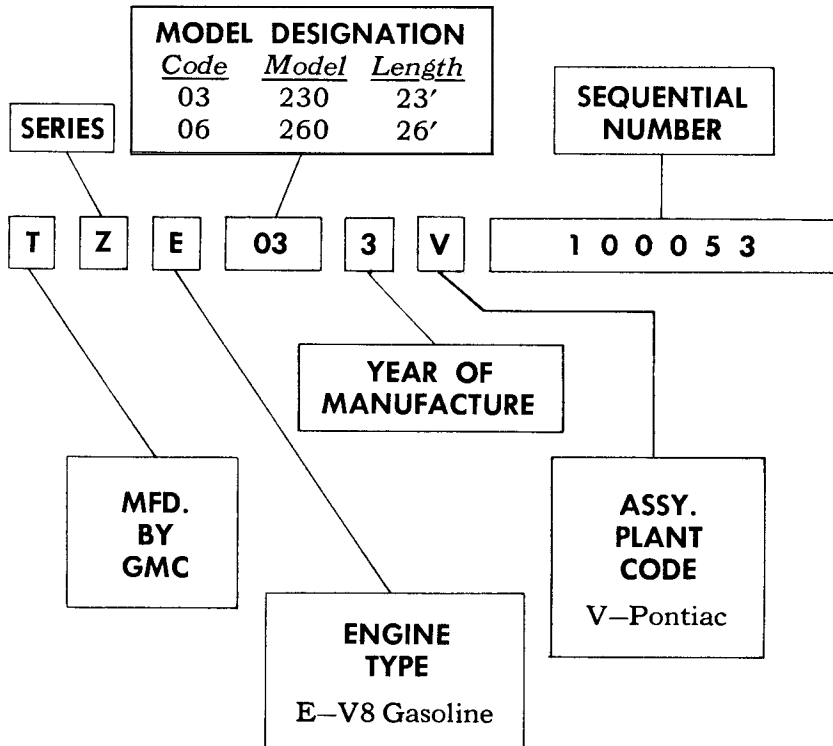

## MOTOR HOME DIMENSIONS

|                                              |                                           |
|----------------------------------------------|-------------------------------------------|
| Track .....                                  | Front - 75.28 in.                         |
|                                              | Rear - 82.12 in.                          |
| Wheelbase .....                              | Model 230 .... 140 in.                    |
|                                              | Model 260 .... 160 in.                    |
| Length (Including optional spare tire) ..... | Model 230.. 23 ft.-9 in.                  |
|                                              | Model 260.. 26 ft.-9 in.                  |
| Length (Including optional Trunk) .....      | Model 230.. 24 ft.-8 in.                  |
|                                              | Model 260.. 27 ft.-8 in.                  |
| Width .....                                  | 96 in.                                    |
| Height .....                                 | 8 ft.-1 in.                               |
|                                              | With Roof Air Conditioner ... 9 ft.-2 in. |
| Front Overhang .....                         | All Models .... 42 in.                    |
| Rear Overhang .....                          | Model 230 .... 69 in.                     |
|                                              | Model 260 .... 89 in.                     |
| Interior Ceiling Height .....                | 76 in.                                    |



## CAPACITIES

|                                  |                                  |
|----------------------------------|----------------------------------|
| Fuel System .....                | Two, 25 Gal. Tanks               |
| Cooling System .....             | 21 Qts.                          |
| Engine Oil .....                 | 5 Qts. (Including Filter 6 Qts.) |
| Turbo Hydramatic .....           | Drain & Refill 4 Qts.            |
|                                  | After Complete Overhaul 10 Qts.  |
| Final Drive (Differential) ..... | 4 Pts.                           |
| Power Steering Pump .....        | 1/2 Qt.                          |
| Power Steering System .....      | 1 1/2 Qt.                        |
| LP Gas Tank .....                | 44.5 Lbs.                        |
|                                  | (Optional Tank) 65.0 Lbs.        |
| Living Area Water Tank .....     | 40 Gal.                          |
| Holding Tank .....               | 40 Gal.                          |
| Hot Water Tank .....             | 6 Gal.                           |

## ENGINE

|                         |                         |
|-------------------------|-------------------------|
| Displacement .....      | 455 cu. in.             |
| Carburetor .....        | 4 Barrel                |
| Compression Ratio ..... | 8.5 : 1                 |
| Bore .....              | 4.125 in.               |
| Stroke .....            | 4.250 in.               |
| Firing Order .....      | 1-8-4-3-6-5-7-2         |
| Dwell .....             | 30°                     |
| Timing .....            | 8° BTDC @ 1100 RPM      |
| Slow Idle Screw .....   | 600 RPM in Drive        |
| Fast Idle Screw .....   | 1100 RPM in "P" or "N"  |
| Spark Plugs .....       | AC R45S                 |
| Spark Plug Gap .....    | .040 in.                |
| Valve Lash .....        | Hydraulic               |
| Idle Mixture .....      | Do Not Remove Caps      |
| Fuel Requirements ..... | Use 91 Octane or Higher |

## BATTERIES

|                                   | <u>Type</u>                       |
|-----------------------------------|-----------------------------------|
| Main (Automotive) Bat. ....       | E5000 R91                         |
| Auxiliary (Living Area) Bat. .... | E5000 R91                         |
| Motor Generator Bat. ....         | E3000 Y87                         |
|                                   | E5000 R91 Rated 3350 Watts @ 0°F. |
|                                   | E3000 Y87 Rated 2300 Watts @ 0°F. |

## MISCELLANEOUS

|                                       |              |
|---------------------------------------|--------------|
| Radiator Cap (pressure opening) ..... | 9 PSI        |
|                                       | AC Type RC32 |
| Thermostat .....                      | 195°F.       |
| Power Converter Output .....          | 30 Amps.     |
| (Optional) .....                      | 45 Amps.     |
| Furnace—Forced Air .....              | 22,000 BTU   |
| (Optional) .....                      | 30,000 BTU   |
| Roof Mounted Air Conditioning .....   | 13,500 BTU   |

## TIRE INFORMATION

SEE "Wheels and Tires" in the SERVICE AND MAINTENANCE SECTION of this manual and the tire placard on the glove box door.

## FILTER RECOMMENDATIONS

|                    |                 |
|--------------------|-----------------|
| Engine Air Cleaner | AC Type A212CW  |
| Engine Oil         | AC Type PF30    |
| Transmission Oil   | AC Type PF160   |
| Engine Fuel        | AC Type GF441   |
| PCV Valve          | AC Type CV697C  |
| Carbon Canister    | GM Part 7026014 |

## FRONT END ALIGNMENT

|                  |                          |
|------------------|--------------------------|
| Caster (Degrees) | -2¼ ±1                   |
| Camber (Degrees) | R.H. -¼ ±¾<br>L.H. +¼ ±¾ |
| Toe-In (Inches)  | 0 ±½                     |

## ONAN MOTOR GENERATOR (6000 WATT — 50 AMP)

|                                 |                                      |
|---------------------------------|--------------------------------------|
| Bore                            | 3¼ in.                               |
| Stroke                          | 3 in.                                |
| Oil Capacity                    | 3 Qt.<br>(With Filter Change) 3½ Qt. |
| Spark Plug Type                 | AC R46S                              |
| Spark Plug Gap                  | .025 in.                             |
| Breaker Point Gap               | .020 in.                             |
| Ignition Timing                 | 21° BTDC                             |
| Tappet Adjustment (Engine Cold) |                                      |
| Intake                          | .003 in.                             |
| Exhaust                         | .010 in.                             |

## ONAN MOTOR GENERATOR (4000 WATT — 33 AMP)

|                                 |                                      |
|---------------------------------|--------------------------------------|
| Bore                            | 3⅛ in.                               |
| Stroke                          | 2⅝ in.                               |
| Oil Capacity                    | 3 Qt.<br>(With Filter Change) 3½ Qt. |
| Spark Plug Type                 | AC R46S                              |
| Spark Plug Gap                  | .025 in.                             |
| Breaker Point Gap               | .020 in.                             |
| Ignition Timing                 | 21° BTDC                             |
| Tappet Adjustment (Engine Cold) |                                      |
| Intake                          | .003 in.                             |
| Exhaust                         | .010 in.                             |

## KOHLER MOTOR GENERATOR (4000 WATT — 33 AMP)

|                                 |                                   |
|---------------------------------|-----------------------------------|
| Bore .....                      | 3 <sup>3</sup> / <sub>4</sub> in. |
| Stroke .....                    | 3 <sup>1</sup> / <sub>4</sub> in. |
| Oil Capacity .....              | 3 Qt.                             |
| Spark Plug Type .....           | AC CR45L                          |
| Spark Plug Gap .....            | .025 in.                          |
| Breaker Point Gap .....         | .020 in.                          |
| Ignition Timing .....           | 20° BTDC                          |
| Tappet Adjustment (Engine Cold) |                                   |
| Intake .....                    | .010 in.                          |
| Exhaust .....                   | .020 in.                          |

### VEHICLE FUSES AND CIRCUIT BREAKERS

The following fuses are located in the fuse block behind the glove box in the dash. Do not use fuses of higher amperage rating than those specified below — or property damage may result.

| <u>Usage</u>                                                                                     | <u>Name on Fuse Block</u> | <u>Fuse Type</u> |
|--------------------------------------------------------------------------------------------------|---------------------------|------------------|
| Auxiliary Battery Switch,<br>Radio,<br>Tape Player                                               | Aux. Bat. - Radio         | AGC-10           |
| Heater Controls,<br>Air Conditioner                                                              | Htr. - A/C                | AGC-25           |
| Side Marker Lights,<br>I.D. & Clearance Lights,<br>Tail Lights,<br>Dome Lights,<br>License Light | Tail - Dome               | SFE-20A          |
| Stop Lights,<br>Hazard Warning Lights,<br>Turn Signal Lights                                     | Dir. Sig. - Haz. & Stop   | SFE-20A          |
| Windshield Washers                                                                               | Washer                    | AGC-10           |
| Cigar-Cigarette Lighter                                                                          | Ltr.                      | SFE-20A          |
| Cruise Control,<br>Back-up Lights                                                                | Cruise - B/U Lps.         | SFE-20A          |
| Transmission Control,<br>Parking Brake Light,<br>Gauges                                          | Gauges - Trans.           | SFE-10A          |
| Instrument Lamps                                                                                 | Inst. Lps.                | SFE-4A           |
| Warning<br>Tell-Tale Lights                                                                      | Tell-Tales                | AGC-10           |

## VEHICLE FUSES AND CIRCUIT BREAKERS (Con't)

The following circuits employ circuit breakers or have fuses located as indicated:

|                                                         |                                                               |
|---------------------------------------------------------|---------------------------------------------------------------|
| Headlight Circuit Breaker . . . . .                     | Built Into Light Switch                                       |
| Heater Blower AGA 30 . . . . .                          | Built Into Line At<br>Right Access Door Near<br>Heater Blower |
| Warning & Signal Flasher GM No. 673499 . . . . .        | In Clip Behind<br>Instrument Panel                            |
| Vehicle Trouble Light AGC-10 . . . . .                  | In Line, Behind<br>Access Door, Near Light                    |
| Air Suspension Compressor 30A Circuit Breaker . . . . . | In Fuse Block                                                 |

## LIVING AREA 12-VOLT SYSTEM FUSES

The following are located in the fuse block in the living area electrical compartment, near the hall closet. Do not use fuses of higher amperage rating than those specified below, or damage may result.

| <u>Usage</u>                                                                          | <u>No. on<br/>Fuse Block</u> | <u>Fuse<br/>Type</u> |
|---------------------------------------------------------------------------------------|------------------------------|----------------------|
| L. H. Dinette Light<br>R. H. Reading Light<br>Bath Light                              | No. 1                        | AGC-15               |
| L. H. Reading Light<br>Porch Light<br>Hall Light<br>R. H. Dinette Light<br>Step Light | No. 2                        | AGC-10               |
| Furnace Blower<br>Range Hood and Lights<br>Kitchen Light                              | No. 3                        | AGC-15               |
| Water Pump                                                                            | No. 4                        | AGC-10               |
| Refrigerator<br>Recir. Toilet                                                         | No. 5                        | AGC-15               |
| Monitor                                                                               | No. 6                        | AGC-5                |
| Roof Vent Fans                                                                        | No. 7                        | AGC-10               |
| Compartment Lights<br>Aisle Lights                                                    | No. 8                        | AGC-5                |

## LIGHT BULB SPECIFICATIONS (INSTRUMENT PANEL)

| <u>Usage</u>                        | <u>Quantity</u> | <u>Bulb. No.</u> |
|-------------------------------------|-----------------|------------------|
| Alternator Tell Tale                | 1               | 161              |
| Brake System Tell Tale              | 1               | 161              |
| Generator Tell Tale                 | 1               | 161              |
| Park Brake Tell Tale                | 1               | 161              |
| Cruise Control Tell Tale            | 1               | 161              |
| Door Ajar Tell Tale                 | 1               | 161              |
| Low Fuel Tell Tale                  | 1               | 161              |
| High Beam Indicator                 | 1               | 161              |
| Turn Signal Indicator               | 2               | 168              |
| Instrument Cluster Lights           | 2               | 194              |
| Speedo Cluster Lights               | 2               | 194              |
| Dome Lights                         | 2               | 211              |
| Radio Dial (AM/FM/Stereo/Tape)      | 1               | 566              |
| Radio Dial (Exc. AM/FM/Stereo/Tape) | 1               | 1893             |
| Heater Control                      | 1               | 1895             |

## LIGHT BULB SPECIFICATIONS (EXTERIOR)

| <u>Usage</u>             | <u>Quantity</u> | <u>Bulb No.</u> |
|--------------------------|-----------------|-----------------|
| Clearance and I.D.       | 10              | 67              |
| License                  | 1               | 67              |
| Side Markers—Front       | 2               | 194             |
| Side Markers—Rear        | 2               | 194             |
| Back-Up Lights           | 2               | 1156            |
| Parking and Turn Signals | 2               | 1157            |
| Stop and Tail            | 2               | 1157            |
| Headlights               | 2               | 6014            |

## LIGHT BULB SPECIFICATIONS (LIVING AREA)

| <u>Usage</u>                    | <u>Quantity</u> | <u>Bulb. No.</u> |
|---------------------------------|-----------------|------------------|
| R.H. Dinette Light              | 2               | 1141             |
| L. H. Dinette Light             | 2               | 1141             |
| Kitchen Light                   | 2               | 1141             |
| Hall Light                      | 2               | 1141             |
| Porch Light                     | 1               | 1141             |
| Compartment Lights              | 5               | 1141             |
| Range Hood Lights               | 2               | 1156             |
| Rear Compartment Reading Lights | 2               | 1383             |
| Bathroom Lights                 | 6               | 93               |
| Aisle Lights                    | 3               | 67               |
| Step Light                      | 1               | 67               |

## 120-VOLT SYSTEM CURRENT RATING

|                                  |           |
|----------------------------------|-----------|
| Water Heater .....               | 10.0 Amp. |
| Power Converter .....            | 6.8 Amp.  |
| Refrigerator .....               | 2.2 Amp.  |
| Roof Mount Air Conditioner ..... | 16.5 Amp. |
| Vacuum Cleaner .....             | 7.0 Amp.  |

## 12-VOLT LIVING AREA COMPONENTS CURRENT RATING

|                                      |            |
|--------------------------------------|------------|
| R.H. Dinette Light .....             | 2.88 Amp.  |
| L.H. Dinette Light .....             | 2.88 Amp.  |
| Hall Light .....                     | 2.88 Amp.  |
| R.H. Reading Light .....             | 1.50 Amp.  |
| L.H. Reading Light .....             | 1.50 Amp.  |
| Kitchen Light .....                  | 1.44 Amp.  |
| Aisle Lights (Per Light) .....       | .59 Amp.   |
| Compartment Lights (Per Light) ..... | .59 Amp.   |
| Porch Light .....                    | .59 Amp.   |
| Step Light .....                     | .59 Amp.   |
| Bath Room Lights .....               | 5.64 Amps. |
| Range Hood Vent Fan and Lights ..... | 5.50 Amps. |
| Furnace Blower .....                 | 6.1 Amp.   |
| Water Pump .....                     | 6.2 Amp.   |
| Refrigerator .....                   | 6.0 Amp.   |
| Recirculating Toilet .....           | 4.8 Amp.   |
| Monitor Panel .....                  | 2.5 Amp.   |
| Front Vent Fan .....                 | 2.8 Amp.   |
| Rear Vent Fan .....                  | 2.8 Amp.   |
| Bath Vent Fan .....                  | 2.8 Amp.   |



# OWNER ASSISTANCE

The satisfaction and goodwill of the owners of GMC Motor Homes is of primary concern to your service outlet and the GMC Truck & Coach Division. Normally, any problems that arise in connection with the sales transaction or the operation of your vehicle will be handled by your dealer's Sales or Service Departments. It is recognized, however, that despite the best intentions of everyone concerned, misunderstandings will sometimes occur. If you have a problem that has not been handled to your satisfaction through normal channels, we suggest that you take the following steps:

**STEP ONE**—Discuss your problem with a member of dealership management. Frequently, complaints are the result of a breakdown in communications and can quickly be resolved by a member of the dealership management. If the problem already has been reviewed with the Sales Manager or Service Manager, or contact the Service Outlet Manager.

**STEP TWO**—Contact the GMC Truck & Coach Division Zone Office closest to you listed on page 132 (or in Canada contact The General Motors Zone Office). When it appears that your problem cannot be readily resolved by the service outlet without additional assistance, the matter should be called to the attention of the Zone's Owner Relations Department and the following information provided:

- Your name, address, telephone number
- Year and model vehicle
- Service Outlet's name and location
- Vehicle's delivery date and mileage
- Nature of problem

**STEP THREE**—Contact the Owner Relations Manager, GMC Truck & Coach Division, 660 South Blvd. East, Pontiac, Michigan 48053 (phone 313-335-4111; ext. 7677) or in Canada, contact the Owner Relations Supervisor, General Motors of Canada Limited, Oshawa, Ontario (phone 416-644-6624). If after an additional review of all facts involved he feels that some further action can be taken, he will so instruct the Zone. In any case, your letter will be acknowledged providing GMC Truck & Coach Division's position in the matter.

When contacting the Zone or Home Office, please bear in mind that ultimately your problem likely will be resolved in the service outlet utilizing the service outlet's facilities, equipment and personnel. It is suggested, therefore, that you follow the above steps in sequence when pursuing a problem.

Your purchase of a GMC Motor Home is greatly appreciated by both your service outlet and GMC Truck & Coach Division. It is our sincere desire to assist you in any way possible to assure your complete satisfaction with your vehicle.



# U.S. MOTOR HOME SERVICE OUTLET LOCATIONS

## ARIZONA

Tony M. Coury Buick, Inc.  
Mesa, Arizona  
(602)-964-2491

Jimmy GMC  
Tucson, Arizona  
(602)-624-8281

## CALIFORNIA

Bill Barry Pontiac  
Santa Ana, California  
(714)-541-2681

Dan Day Pontiac, Inc.  
Fresno, California  
(209)-268-4721

Larry Hopkins Pontiac  
Sunnyvale, California  
(415)-736-5474

707-737-8404 ←

Reynolds Buick, Inc.  
West Covina, California  
(213)-966-4461

Mission Valley Truck Sales, Inc.  
San Diego, California  
(714)-283-7222

Service Oldsmobile-GMC, Inc.  
Long Beach, California  
(213)-531-2440

## COLORADO

Seifert Pontiac, Inc.  
Aurora, Colorado  
(303)-751-3400

## CONNECTICUT

Stephen Pontiac-Cadillac, Inc.  
Bristol, Connecticut  
(203)-583-1801

## FLORIDA

Bert Smith Oldsmobile, Inc.  
St. Petersburg, Florida  
(813)-527-1111

Coggin Pontiac, Inc.  
Jacksonville, Florida  
(904)-724-2310

King Motor Company of Ft. Lauderdale  
Ft. Lauderdale, Florida  
(305)-764-2122

McNamara Pontiac, Inc.  
Orlando, Florida  
(305)-241-9601

## GEORGIA

Trade City Motor Company  
Marietta, Georgia  
(404)-427-5545

## ILLINOIS

Benhart's GMC, Inc.  
Glen Ellyn, Illinois  
(312)-665-3140

Community Motors, Inc.  
Oak Forest, Illinois  
(312)-687-0400

## INDIANA

General GMC Truck Sales, Inc.  
Muncie, Indiana  
(317)-289-4481

Midwest Truck Sales & Service, Inc.  
Indianapolis, Indiana  
(317)-545-7601

## KANSAS

Davis-Moore Oldsmobile, Inc.  
Wichita, Kansas  
(316)-685-0221

# U.S. MOTOR HOME SERVICE OUTLET LOCATIONS

## KENTUCKY

Tri City Oldsmobile, Inc.  
Louisville, Kentucky  
(502)-897-6541

## MARYLAND

King Pontiac, Inc.  
Gaithersburg, Md.  
(301)-948-9111

## MASSACHUSETTS

V & P Truck Center  
Methuen, Mass.  
(617)-686-9408

## MICHIGAN

Audette Pontiac, Inc.  
Troy, Michigan  
(313)-643-8600

Jim Causley Pontiac, Inc.  
Detroit, Michigan  
(313)-886-1700

Orson E. Coe Pontiac, Inc.  
Grand Rapids, Michigan  
(616)-949-7700

McMullen Pontiac, Inc.  
Pontiac, Michigan  
(313)-681-2600

Red Holman Pontiac Co.  
Westland, Michigan  
(313)-721-1144

## MISSOURI

Ackerman Buick, Inc.  
St. Louis, Missouri  
(314)-524-2900

## NEBRASKA

McKenzie Pontiac, Inc.  
Omaha, Nebraska  
(402)-344-4400

## NEW JERSEY

Maxon Pontiac, Inc.  
Union, N. J.  
(201)-964-1600

## NEW YORK

Jim Culligan Pontiac, Inc.  
Williamsville, N. Y.  
(716)-633-4000

McNamara Travel Homes  
Port Jefferson Station, N. Y.  
(516)-473-0263

## NORTH CAROLINA

Bill Beck Pontiac, Inc.  
Charlotte, N. C.  
(704)-536-1234

## OHIO

Geo. Byers Sons, Inc.  
Columbus, Ohio  
(614)-228-5111

Stan Grueninger Oldsmobile, Inc.  
Woodlawn, Ohio  
(513)-771-8888

Gene Norris Oldsmobile, Inc.  
Middleburg Heights, Ohio  
(216)-243-0660

Bachus-Palmert GMC Truck, Inc.  
Dayton, Ohio  
(513)-298-8655

## OKLAHOMA

Dean Bailey Olds, Inc.  
Tulsa, Oklahoma  
(918)-622-2770

Jackie Cooper Oldsmobile, Inc.  
Yukon, Oklahoma  
(405)-354-2526

# U.S. MOTOR HOME SERVICE OUTLET LOCATIONS

## OREGON

Mike Salta Pontiac, Inc.  
Portland, Oregon  
(503)-255-9711

## PENNSYLVANIA

Blake Cadillac-Oldsmobile, Inc.  
Harrisburg, Pennsylvania  
(717)-232-4164

Cochran Pontiac, Inc.  
Monroeville, Pa.  
(412)-373-3333

Al Wilson Pontiac, Inc.  
Warminster, Pennsylvania  
(215)-052-8000

## TENNESSEE

Bluff City Buick Company, Inc.  
Memphis, Tennessee  
(901)-744-0150

General Truck Sales  
Nashville, Tennessee  
(615)-244-5400

## TEXAS

Burke Oldsmobile Co.  
San Antonio, Texas  
(512)-824-0411

R. O. Evans Pontiac-GMC  
Dallas, Texas  
(214)-328-8411

## TEXAS (Con't)

Frank Gillman Pontiac, Inc.  
Houston, Texas  
(713)-771-3611

GMC Quality Trucks, Inc.  
El Paso, Texas  
(915)-778-6435

## UTAH

Peck & Shaw Fine Cars, Inc.  
Salt Lake City, Utah  
(801)-262-8401

## VIRGINIA

Bingham GMC Trucks, Inc.  
Richmond, Va.  
(703)-353-1277

Phillips Oldsmobile, Inc.  
Virginia Beach, Virginia  
(703)-499-3771

## WASHINGTON

Valley Pontiac-GMC, Inc.  
Auburn, Washington  
(206)-833-1143

## WISCONSIN

Arrow Oldsmobile-GMC, Inc.  
Milwaukee, Wisconsin  
(414)-281-4000



U.S. ZONE TERRITORIES

## U.S. ZONE OFFICES

*When calling for assistance, please ask for Owner Relations Manager*

### ATLANTA

5373 Peachtree Industrial Blvd.  
Chamblee, Georgia 30341  
451-9461  
Area Code 404

### BOSTON

20 Cross St.  
Woburn, Mass. 01801  
935-6850  
Area Code 617

### CHARLOTTE

1914 W. Morehead  
P.O. Box 8149  
Freedom Station  
Charlotte, N. C. 28208  
332-4181-82-83  
Area Code 704

### CHICAGO

2021 Spring Rd.  
Oakbrook, Ill. 60521  
654-6467

### CINCINNATI

8075 Reading Road  
Carrousel Towers  
Cincinnati, Ohio 45237  
751-9760  
Area Code 513

### DALLAS

6007 Peelar Street  
P.O. Box 35187  
Airlawn Station  
Dallas, Texas 75235  
358-5316  
Area Code 214

### DENVER

4715 Colorado Blvd.  
Denver, Colo. 80216  
388-1611  
Area Code 303

### DETROIT

650 South Blvd. East  
Pontiac, Mich. 48053  
335-4111 ext. 3052  
Area Code 313

### KANSAS CITY

3100 Fiberglas Road  
Kansas City, Kans. 66115  
621-5890  
Area Code 913

### LOS ANGELES

8155 Van Nuys Blvd.  
Suite 1030 Panorama Towers  
Panorama City, Calif. 91402  
873-7554  
Area Code 213

### MEMPHIS

670 E. Huron St.  
Box 7355 North Station  
Memphis, Tennessee 38107  
525-2481  
Area Code 901

### MINNEAPOLIS

3001 Broadway N.E.  
Minneapolis, Minn. 55413  
331-4282  
Area Code 612

### NEW YORK

780 Dowd Avenue  
Elizabeth, N.J. 07207  
354-8200  
Area Code 201

### OAKLAND

10626 E. 14th Street  
Oakland, Calif. 94603  
568-7510  
Area Code 415

### PITTSBURGH

Russelton Road  
Cheswick, Pa. 15024  
274-8000  
Area Code 412

### PORTLAND

5355 S.W. Western Avenue  
Beaverton, Ore. 97005  
646-8311  
Area Code 503

### ST. LOUIS

Suite 226  
Crestwood Executive Center  
St. Louis, Mo. 63126  
849-0990  
Area Code 314

### SAN ANTONIO

8622 Crownhill Blvd.  
San Antonio, Texas 78209  
826-8607  
Area Code 512

### WASHINGTON

Suite 410—Profess. Bldg.  
1109 Spring St.  
Silver Spring, Md. 20910  
585-7200  
Area Code 301

### HAWAII (HONOLULU)

1600 Kapiolani Blvd.  
Suite 714  
346-3988  
Honolulu, Hawaii 96814  
Area Code 808

*Note: The State of Alaska is serviced by the Portland Zone.*

## MEXICO ZONE OFFICE

General Motors de Mexico S.A. de C.V. Av. Ejercito Nacional No. 843 Mexico 5, D.F.  
Phone No. 545-3921

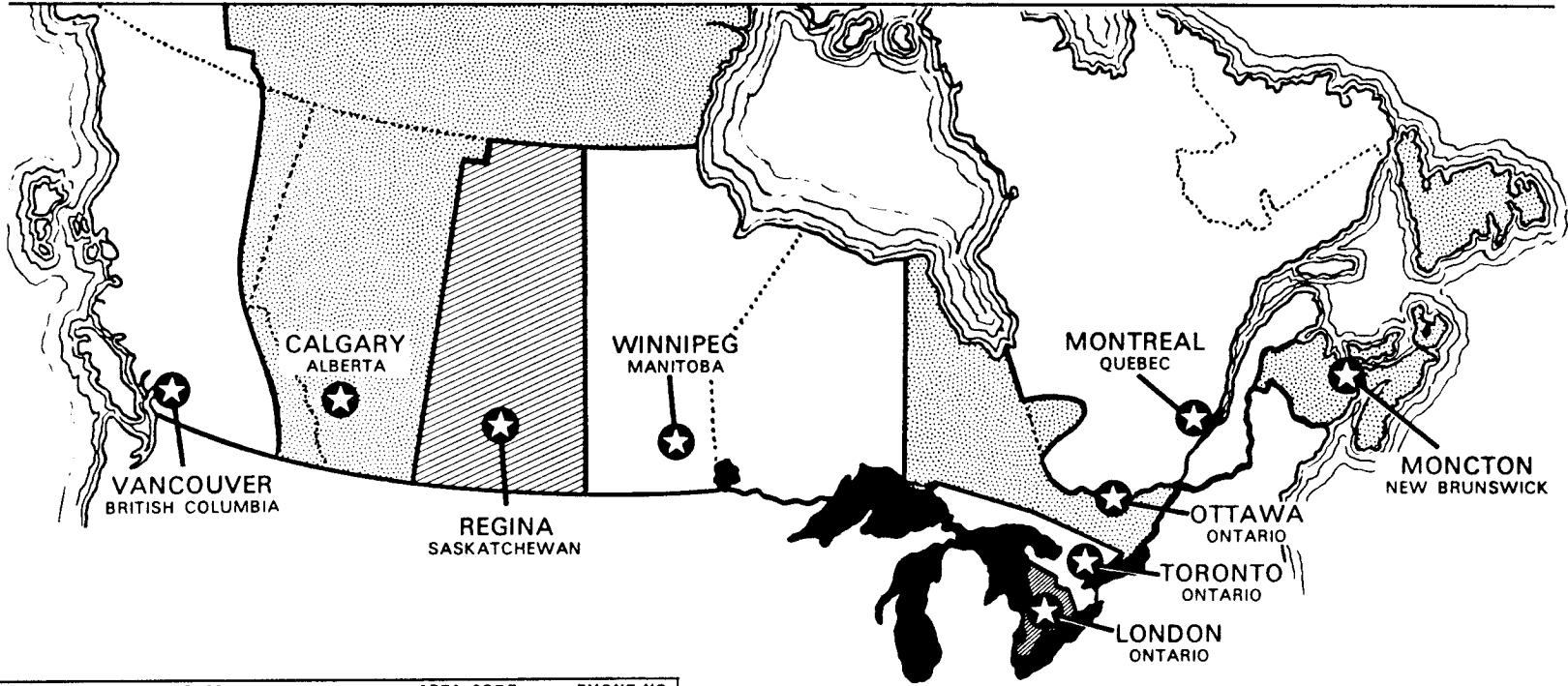

| ZONES     | ADDRESS                                                | AREA CODE | PHONE NO. |
|-----------|--------------------------------------------------------|-----------|-----------|
| VANCOUVER | 900 Terminal Avenue<br>Vancouver 4, B.C.               | 604       | 684-9444  |
| CALGARY   | 4220 Blackfoot Trail<br>Box 2510<br>Calgary 2, Alberta | 403       | 243-4621  |
| REGINA    | 581 Park Street<br>Regina, Sask.                       | 306       | 643-2224  |
| WINNIPEG  | 1345 Redwood Avenue<br>Winnipeg 14, Man.               | 204       | 582-2371  |
| LONDON    | Box 5412—Terminal "A"<br>London, Ontario               | 519       | 455-2400  |

| ZONES    | ADDRESS                                             | AREA CODE | PHONE NO. |
|----------|-----------------------------------------------------|-----------|-----------|
| TORONTO  | 1200 Eglinton Ave. East<br>Don Mills, Ont.          | 416       | 446-5000  |
| OTTAWA   | 875 Belfast Road<br>Ottawa 8, Ont.                  | 613       | 237-5051  |
| MONTREAL | 5000 Trans-Canada Hwy.<br>Pointe Claire 730, Quebec | 514       | 697-4940  |
| MONCTON  | 653 St. George Street<br>Moncton, N.B.              | 506       | 854-1500  |



**GMC**  
**SUDDEN**  
**SERVICE**  
**SYSTEM**  
(FOR OWNERS)

Need answers to Motor Home service and maintenance questions . . . answers to parts requirements questions . . . answers to recommended Motor Home specifications questions? Now GMC offers you direct-to-factory communications. You talk with Motor Home experts at Pontiac, Michigan. Motor Home experts solve Motor Home problems. That's why we're the Motor Home people from General Motors. If you need us, dial toll free Monday through Friday, between 8:00 AM and 5:00 PM (EST).

**800-521-2800**  
In Michigan call: **800-572-7953**

### **AFTER-HOUR SERVICE ASSISTANCE**

Most service outlets will have after-hour service assistance. If you have attempted to contact a Motor Home service outlet after normal business hours, without success, you may call toll-free the number below. The operator will give you the location and phone number of the nearest outlet that provides after-hour assistance.

**800-521-2806**  
In Michigan call: **800-572-7959**

It should be understood, however, that any charges for after-hours service assistance must be borne by the owner. In those instances where the repair qualifies under our published warranty, the dealership charge for additional services, such as for, after normal business hour repairs will be the owner's expense.

### **MAINTENANCE MANUAL**

An order for purchase of a GMC Motor Home Maintenance Manual can be placed by writing – Service Publications, GMC Truck & Coach Division, 660 South Blvd. East, Pontiac, Michigan 48053. Canadian residents should order the manual from the Owner Relations Department, General Motors of Canada, Limited, Oshawa, Ontario.

# INDEX

| SUBJECT                             | PAGE NO.   | SUBJECT                         | PAGE NO.  |
|-------------------------------------|------------|---------------------------------|-----------|
| <b>A</b>                            |            |                                 |           |
| Absorbers, Shock                    | 99, 100    | Brakes                          |           |
| Accessory Position, Ignition Switch | 14         | Linings                         | 19        |
| Adjusters, Automatic Brake          | 18         | Master Cylinder Level           | 79        |
| After-Hour Service Assistance       | 134        | Parking Brake                   | 19        |
| Air Circulation                     | 23, 24, 47 | Power                           | 17        |
| Air Cleaner                         | 71, 83     | Self Adjusting                  | 18        |
| Air Compressor                      | 69, 101    | Trailer                         | 10        |
| Air Conditioning                    |            | Warning Light                   | 21        |
| Automotive                          | 24         | Break-In Period                 |           |
| Roof Mount                          | 47         | New Vehicle                     | 11        |
| Air Inlets, Ventilation             | 47         | Vehicle Pulling Trailer         | 10        |
| Air Suspension                      | 100        | Bright Metal Cleaning           | 61        |
| Alignment, Wheel                    | 121        | B.T.U. Ratings                  | 120       |
| Antenna                             | 26         | Bulbs and Fuses                 | 122-124   |
| Anti-theft Steering Column Lock     | 14         | Bumpers—Energy Absorbing        | 3         |
| Appearance Care                     | 59         | Bunk Beds                       | 51        |
| Automatic Transmission              |            | <b>C</b>                        |           |
| Fluid Check                         | 68, 77     | Cap, Filler                     |           |
| Fluid Recommendations               | 74         | Engine Oil                      | 64        |
| Maintenance                         | 77         | Gasoline                        | 81        |
| Operation                           | 15         | Living Area Water Tank          | 7, 35     |
| Starter Safety Switch               | 70         | Power Steering Reservoir        | 78        |
| Auxiliary Battery                   | 23         | Radiator                        | 79        |
| Auxiliary Fuel Tank                 | 23         | Capacities                      | 120       |
| Axle, Final Drive                   | 78         | Carbon Monoxide Caution         | 13, 29    |
| <b>B</b>                            |            |                                 |           |
| Bathroom                            |            | Carburetor, Engine              | 82        |
| Drains                              | 107        | Adjustment                      | 82        |
| Lights                              | 31         | Air Cleaner                     | 71, 83    |
| Roof Fan                            | 47         | Carpet Care                     | 59        |
| Roof Vent                           | 47         | Changing Wheels & Tires         | 55, 96-99 |
| Shower                              | 45         | Charging System Indicator Light | 21        |
| Sink                                | 45         | Chassis Lubrication             | 76        |
| Toilets                             | 43         | Check List                      | 5         |
| Batteries                           |            | Child Restraints                | 9         |
| Emergency Starting                  | 53         | Chrome Protection               | 61        |
| Fluid Level                         | 84, 92, 96 | Cigar Lighter                   | 23        |
| Gas Caution                         | 85, 93, 96 | Circuit Breaker, Headlights     | 19        |
| Location                            | 64, 92     | Circuit Breaker Panel           | 29, 88    |
| Battery Boost Switch                | 23         | Clean Air Act, Federal          | 115       |
| Battery Charger, Power Converter    | 30         | Cleaning                        |           |
| Bearings, Rear Wheel                | 99         | Carpet Care                     | 59        |
| Bedroom                             | 51         | Exterior Finish and Trim        | 61        |
| Beds                                | 51         | Fabric and Interior Trim        | 60        |
| Before Driving Your Motor Home      | 5          | Spot Removal                    | 60        |
| Belts, Lap                          | 8, 60, 69  | Vacuum Cleaner                  | 59        |
| Blower, Ventilating                 | 24         | Cold Weather Starting           | 15        |
| Body Identification Number          | 119        | Compartment                     |           |
|                                     |            | Engine                          | 65        |
|                                     |            | External Utilities              | 30        |



| SUBJECT                             | PAGE NO. |
|-------------------------------------|----------|
| Front Access . . . . .              | 64       |
| Glove . . . . .                     | 7        |
| Living Area Water . . . . .         | 104      |
| L.P. Gas . . . . .                  | 84       |
| Complaint Procedure . . . . .       | 127      |
| Conditioner, Air                    |          |
| Automotive . . . . .                | 24       |
| Roof Mounted . . . . .              | 47       |
| Converter, Power . . . . .          | 29       |
| Converting Davo to Beds . . . . .   | 51       |
| Converting Dinette to Bed . . . . . | 50       |
| Converting Goucho to Bed . . . . .  | 52       |
| Cooling System                      |          |
| Care . . . . .                      | 79       |
| Coolant Recommendation . . . . .    | 74       |
| Overheating Caution . . . . .       | 55       |
| Cruise Control . . . . .            | 17       |
| Customer Service . . . . .          | 127, 134 |

**D**

|                                             |        |
|---------------------------------------------|--------|
| Davo . . . . .                              | 51     |
| Dealers . . . . .                           | 128    |
| Defrosters . . . . .                        | 24     |
| Differential, Final Drive . . . . .         | 78     |
| Dimensions, Vehicle . . . . .               | 119    |
| Dimmer Switch, Headlamp . . . . .           | 19     |
| Dinette . . . . .                           | 50     |
| Dining Room . . . . .                       | 50     |
| Directional Signal . . . . .                | 16     |
| Distributor . . . . .                       | 86     |
| Dome Lights . . . . .                       | 22     |
| Drainage System . . . . .                   | 107    |
| Draining Holding Tank . . . . .             | 103    |
| Draining Living Area Water System . . . . . | 104    |
| Drain Traps . . . . .                       | 107    |
| Driver Check List . . . . .                 | 5      |
| Driver's Seat . . . . .                     | 6      |
| Driving Tips . . . . .                      | 11     |
| Dump Hose . . . . .                         | 103    |
| Dump Valve . . . . .                        | 104    |
| Dusty Condition, Operation Under . . . . .  | 32, 83 |

**E**

|                                            |            |
|--------------------------------------------|------------|
| Electrical Systems                         |            |
| Batteries . . . . .                        | 23, 29, 84 |
| Battery Boost Switch . . . . .             | 23         |
| Battery Charger, Power Converter . . . . . | 29         |
| Bulbs, Light . . . . .                     | 124        |
| Charging System Indicator Light . . . . .  | 21         |
| Converter, Power . . . . .                 | 29         |
| Diode Assembly . . . . .                   | 23         |
| External Power . . . . .                   | 30         |
| Generating System Precautions . . . . .    | 85         |

| SUBJECT                                     | PAGE NO. |
|---------------------------------------------|----------|
| Lighting System . . . . .                   | 31       |
| Living Area Elec. Compartment . . . . .     | 29, 88   |
| Living Area Fuse Block . . . . .            | 88       |
| Motor Generator . . . . .                   | 31, 32   |
| Emergency Equipment . . . . .               | 10       |
| Emergency Exit . . . . .                    | 57       |
| Emergency, In Case Of . . . . .             | 53       |
| Brake System Warning Light . . . . .        | 21       |
| Charging System Warning Light . . . . .     | 21       |
| Emergency Starting . . . . .                | 53       |
| Hazard Warning Flasher . . . . .            | 53       |
| Jacking Instructions . . . . .              | 55       |
| Jump Starting . . . . .                     | 54       |
| Overheated Engine . . . . .                 | 55       |
| Power Level System . . . . .                | 28       |
| Pushing to Start . . . . .                  | 53       |
| Towing . . . . .                            | 56       |
| Emission Control Maintenance . . . . .      | 71       |
| Emission Control Systems Warranty . . . . . | 118      |
| Energizer (See Batteries) . . . . .         | 84       |
| Energy Absorber—Bumper . . . . .            | 3        |
| Engine Access . . . . .                     | 65       |
| Engine Coolant Reservoir . . . . .          | 79       |
| Engine Compartment . . . . .                | 65       |
| Engine Firing Order . . . . .               | 86       |
| Engine Oil                                  |          |
| Capacity . . . . .                          | 120      |
| Change Interval . . . . .                   | 68, 75   |
| Dip Stick . . . . .                         | 77       |
| Filter . . . . .                            | 75       |
| Pressure Gauge . . . . .                    | 21       |
| Recommendation . . . . .                    | 74       |
| Entrance Door . . . . .                     | 7        |
| Ethylene Glycol Coolant . . . . .           | 80       |
| Evaporation Control System . . . . .        | 117      |
| Exhaust Gas Caution . . . . .               | 13       |
| Exhaust System Maintenance . . . . .        | 69       |
| Parked with Engine Running . . . . .        | 13       |
| Exhaust System . . . . .                    | 69       |
| Exit, Emergency . . . . .                   | 57       |
| Exterior Finish Care . . . . .              | 61       |
| External Power Connection . . . . .         | 30       |
| External Utilities Compartment . . . . .    | 30       |
| External Water Connection . . . . .         | 35       |

**F**

|                                          |     |
|------------------------------------------|-----|
| Fabric Care . . . . .                    | 60  |
| Filling L.P. Gas Tank . . . . .          | 84  |
| Filling Living Area Water Tank . . . . . | 35  |
| Filters . . . . .                        | 121 |
| Final Drive Differential . . . . .       | 78  |
| Finish Care, Exterior . . . . .          | 61  |
| Fire Extinguisher . . . . .              | 57  |

| SUBJECT                                    | PAGE NO.   |
|--------------------------------------------|------------|
| Flammable Cleaning Solvents . . . . .      | 59         |
| Flashers                                   |            |
| Hazard Warning . . . . .                   | 53         |
| Turn Signal . . . . .                      | 16         |
| Flooded Engine . . . . .                   | 15         |
| Floor Controls . . . . .                   | 17         |
| Fluid Capacities . . . . .                 | 120        |
| Fluid Levels and Recommendations . . . . . | 74         |
| Batteries . . . . .                        | 84, 92, 96 |
| Brake Master Cylinder . . . . .            | 79         |
| Engine Oil . . . . .                       | 75         |
| Final Drive . . . . .                      | 78         |
| Power Steering . . . . .                   | 78         |
| Radiator . . . . .                         | 79         |
| Transmission . . . . .                     | 77         |
| Foreign Countries, Operation in . . . . .  | 9          |
| Four Way Hazard Warning Flasher . . . . .  | 16         |
| Front Access Doors . . . . .               | 64         |
| Front Suspension . . . . .                 | 99         |
| Fuel                                       |            |
| Evaporation Controls . . . . .             | 117        |
| Filler Cap Location . . . . .              | 81         |
| Gauge . . . . .                            | 20         |
| Motor Generator . . . . .                  | 32, 33     |
| Recommendations . . . . .                  | 81         |
| Tank Selector Switch . . . . .             | 20, 23     |
| Fumes, Engine Exhaust . . . . .            | 13         |
| Furnace . . . . .                          | 48         |
| Furniture . . . . .                        | 50         |
| Fuses                                      |            |
| Living Area Chart . . . . .                | 123        |
| Living Area Location . . . . .             | 88         |
| Vehicle Chart . . . . .                    | 122        |
| Vehicle Location . . . . .                 | 88         |
| <b>G</b>                                   |            |
| Gas, L.P. . . . .                          | 84         |
| Gas Station Information . . . . .          | 141        |
| Gasoline (See Fuel) . . . . .              | 81         |
| Generator, Delcotron . . . . .             | 85         |
| Generator Indicator Light . . . . .        | 21         |
| Generator, Motor . . . . .                 | 31, 32     |
| General Data & Specifications . . . . .    | 119        |
| Glass and Mirrors . . . . .                | 60         |
| Glove Box . . . . .                        | 7          |
| Goucho . . . . .                           | 52         |
| Gross Vehicle Weight (GVW) . . . . .       | 2          |
| <b>H</b>                                   |            |
| Hazard Warning Flasher . . . . .           | 53         |
| Headlight                                  |            |
| Adjustment . . . . .                       | 87         |
| Flicker . . . . .                          | 19         |

| SUBJECT                                  | PAGE NO. |
|------------------------------------------|----------|
| High Beam Dimmer Switch . . . . .        | 19       |
| High Beam Indicator . . . . .            | 20       |
| Replacement . . . . .                    | 87       |
| Switch . . . . .                         | 22       |
| Heater, Operation . . . . .              | 23       |
| Hitches, Trailer . . . . .               | 10       |
| Hoisting Vehicle . . . . .               | 66       |
| Holding Tank . . . . .                   | 103      |
| Winter Travel . . . . .                  | 11       |
| Horn . . . . .                           | 16       |
| <b>I</b>                                 |          |
| Identification Lights . . . . .          | 22       |
| Identification Number, Vehicle . . . . . | 119      |
| Identification Plate, Vehicle . . . . .  | 2        |
| Ignition, Keys and Lock . . . . .        | 14       |
| Ignition Timing . . . . .                | 86       |
| In Case of Emergency . . . . .           | 53       |
| Indicator Lights . . . . .               | 20       |
| Infant Restraining Methods . . . . .     | 9        |
| Inflation Pressure, Tire . . . . .       | 96       |
| Instrument Panel . . . . .               | 20       |
| Interior Appearance Care . . . . .       | 59       |
| <b>J</b>                                 |          |
| Jack Usage Instructions . . . . .        | 55       |
| Jump Starting . . . . .                  | 54       |
| <b>K</b>                                 |          |
| Keys . . . . .                           | 7        |
| Kitchen Facilities . . . . .             | 37       |
| Power Range Hood . . . . .               | 40       |
| Range/Oven . . . . .                     | 40       |
| Refrigerator . . . . .                   | 37       |
| Sink . . . . .                           | 43       |
| Water Purifier . . . . .                 | 43       |
| Knocking Engine . . . . .                | 81       |
| Kohler Motor Generator . . . . .         | 32       |
| <b>L</b>                                 |          |
| Lane Change and Turn Signal . . . . .    | 16       |
| Lap Belts . . . . .                      | 8, 9     |
| Latch, Door . . . . .                    | 7        |
| Leveling Vehicle . . . . .               | 27       |
| Lighter, Cigar . . . . .                 | 23       |
| Lights                                   |          |
| Aisle . . . . .                          | 31       |
| Brake Warning . . . . .                  | 21       |
| Bright Beam Indicator . . . . .          | 20       |
| Bulb Chart . . . . .                     | 124      |
| Charging System . . . . .                | 21       |

| SUBJECT                            | PAGE NO. |
|------------------------------------|----------|
| Dome                               | 22       |
| Hazard Flasher                     | 53       |
| Headlight Aim                      | 87       |
| Headlight Circuit Breaker          | 19       |
| Headlight Switch                   | 22       |
| Living Area                        | 31       |
| Marker & Clearance                 | 22       |
| Parking Brake                      | 19       |
| Porch                              | 31       |
| Step                               | 31       |
| Tail Lights                        | 22       |
| Tell Tale Warning                  | 22       |
| Turn Signal Indicator              | 20       |
| Linings, Brake                     | 19       |
| Living Area Electrical Compartment | 29       |
| Living Area Electrical System      | 29       |
| Living Area Facilities Caution     | 29       |
| Living Area Lighting               | 31       |
| Loading, Vehicle                   | 1        |
| Locks                              | 7        |
| Low Lead Fuels                     | 81       |
| Low Temperature Operation          | 15       |
| L.P. Gas System                    | 84       |
| Lubrication                        |          |
| Details                            | 75       |
| Lube and General Maintenance       | 68       |
| Lubricants                         | 74       |

### M

|                                 |        |
|---------------------------------|--------|
| Maintenance                     |        |
| Appearance Care                 | 59     |
| Manual                          | 134    |
| Schedule                        | 67     |
| Master Cylinder, Brake          | 79     |
| Marker Lights                   | 22     |
| Metal Cleaners                  | 42, 61 |
| Methods of Restraining Children | 9      |
| Mirrors, Rear View              | 5      |
| Mobile Radio Transmitter        | 27     |
| Monitor Panel                   | 31     |
| Motor Generator                 | 31, 32 |

### N

|                         |        |
|-------------------------|--------|
| New Motor Home Break-In | 10, 11 |
| New Vehicle Warranty    | 111    |

### O

|                           |    |
|---------------------------|----|
| Odometer                  | 20 |
| Oil                       |    |
| Additives                 | 75 |
| Change Interval, Engine   | 68 |
| Checking Engine Oil Level | 75 |
| Filter                    | 75 |

| SUBJECT                        | PAGE NO. |
|--------------------------------|----------|
| Motor Generator                | 91, 95   |
| Pressure Gauge                 | 21       |
| Recommendations                | 75       |
| Transmission                   | 77       |
| Viscosity                      | 75       |
| Onan Motor Generator           | 31       |
| Operation in Foreign Countries | 9        |
| Oven Operation                 | 40       |
| Overheated Engine              |          |
| Temperature Gauge              | 21       |
| What To Do                     | 21       |
| Owner Assistance               | 127      |
| Owner Safety Checks            | 69       |

### P

|                                       |        |
|---------------------------------------|--------|
| Paint, Care and Touch Up              | 62     |
| Parking                               | 14     |
| Brake                                 | 14, 19 |
| Lights                                | 22     |
| Pilot Lights                          |        |
| Furnace                               | 49     |
| Oven                                  | 40, 41 |
| Range                                 | 40, 41 |
| Refrigerator                          | 38     |
| Plugs, Spark                          | 87     |
| Points, Distributor                   | 86     |
| Polishing and Waxing                  | 62     |
| Porch Light                           | 31     |
| Positive Crankcase Ventilation System | 116    |
| Power                                 |        |
| Brakes                                | 17     |
| Converter and Battery Charger         | 29     |
| Level System                          | 27     |
| Vents                                 | 47     |
| Steering                              | 16     |
| Pressure, Tire Inflation              | 96     |

### R

|                           |     |
|---------------------------|-----|
| Radiator and Coolant      | 79  |
| Radio                     |     |
| AM                        | 25  |
| AM/FM                     | 25  |
| Antenna                   | 26  |
| Mobile Transmitter        | 27  |
| Stereo                    | 26  |
| Tape System               | 26  |
| Raising Vehicle With Jack | 55  |
| Range Hood                | 40  |
| Range/Oven                | 40  |
| Rear Suspension           | 100 |
| Rear Wheel Bearings       | 99  |
| Recirculating Toilet      | 44  |



| SUBJECT                   | PAGE NO. |
|---------------------------|----------|
| Toilet                    |          |
| Standard                  | 43, 101  |
| Recirculating             | 44, 102  |
| Towing                    | 56       |
| Trailer Hauling           | 10       |
| Transmission              |          |
| Braking Effect On Hills   | 15       |
| Checking Fluid Level      | 77       |
| Maintenance               | 77       |
| Shift Controls            | 15       |
| Transmitter, Mobile Radio | 27       |
| Tread Wear Indicators     | 98       |
| Trim Care Interior        | 59       |
| Turn Signals              | 16       |

### U

|                        |    |
|------------------------|----|
| Under Body Maintenance | 71 |
| Under Coating          | 62 |
| Upholstery and Carpet  | 59 |

### V

|                                     |        |
|-------------------------------------|--------|
| Vacuum Cleaner                      | 59     |
| Vehicle Identification              | 2, 119 |
| Vehicle Storage                     |        |
| Long Term                           | 106    |
| Short Term                          | 106    |
| Winter                              | 108    |
| Ventilation                         | 47     |
| Vents                               | 47     |
| Volatile Cleaning Solvents, Caution | 59     |

### W

|                         |    |
|-------------------------|----|
| Warning Flasher, Hazard | 53 |
| Warning Lights          |    |
| Brake                   | 21 |
| Charging System         | 21 |
| Cluster                 | 22 |
| Low Fuel                | 22 |

| SUBJECT                  | PAGE NO. |
|--------------------------|----------|
| Warranty                 |          |
| Emission Control Systems | 118      |
| New Vehicle              | 111      |
| Washers, Windshield      | 23       |
| Washing                  | 61       |
| Waste Destruction System | 46       |
| Water                    |          |
| External Connection      | 35       |
| Heater                   | 36       |
| Pump                     | 35       |
| Purifier                 | 43       |
| System                   | 33       |
| Tank                     | 35       |
| Waxing                   | 62       |
| Weight Distribution      | 1        |
| Wheel Alignment          | 122      |
| Wheel Bearings           |          |
| Front                    | 99       |
| Rear                     | 99       |
| Wheel Changing           | 97       |
| Wheel, Tilt Steering     | 16       |
| Windows                  | 47       |
| Windshield               |          |
| Defrosting               | 24       |
| Washers                  | 23       |
| Wipers                   | 22       |
| Winterization            | 106      |
| Wiring Diagrams          | 89, 90   |
| Wrecker, Towing          | 56       |

### Z

|                  |     |
|------------------|-----|
| Zone Offices     |     |
| Canada           | 133 |
| Mexico           | 132 |
| United States    | 132 |
| Zone Territories |     |
| Canada           | 133 |
| United States    | 131 |

## GAS STATION INFORMATION

Refer to **SERVICE AND MAINTENANCE** section for details on removal and installation of engine cover, placing vehicle on suitable hoist, etc.

### CAUTION

To help prevent the possibility of fire or explosion, turn off the LP gas supply at the LP gas tank and be sure all pilots are out, before filling gasoline tanks.

Always check that fluid inputs are made into the correct filler opening to help avoid serious personal injury and property damage.

**GAS CAP**—The cap is equipped with a double set of locking tangs.

To Remove:

- Rotate cap one-half turn counterclockwise to clear the first set of tangs from the slots inside the filler neck. This will allow any residual pressure to escape.
- Pull the cap outward and rotate one-quarter turn counterclockwise to clear second set of tangs. Then remove the cap.
- To install, reverse this procedure.

**NOTE:** If the gas cap requires a replacement, only a cap with the same features should be used. Failure to use the correct cap can result in a serious malfunction of the system. Correct replacement caps may be obtained from your GMC Motor Home service outlet.

**GASOLINE RECOMMENDATION**—Use an unleaded or low-lead fuel of approximately 91 Research Octane Number or higher as commonly sold in the U.S. and Canada.

**FRONT ACCESS DOORS**—Release by turning latch knob to the left to loosen.

**ENGINE DIPSTICK**—Located inside the left front access door. Check oil level as the last operation in a fuel stop. Maintain between “ADD” and “FULL” marks on dipstick.

**ENGINE OIL RECOMMENDATION**—Use only high quality SE oils. The chart in the **SERVICE AND MAINTENANCE** section will serve as a guide for selecting proper oil viscosity.

**WINDSHIELD WASHER**—Check reservoir fluid level regularly. Use a washer fluid, such as GM Optikleen.

**ENERGIZER (BATTERIES)**—Check fluid level monthly utilizing the level indicator cap marked “Delco Eye.” If the transparent eye within the cap glows, fluid level is low. Add only colorless, odorless drinking water or distilled water to bring level to split ring in filler opening.

